

Mimaki

DM3-1810S

FLATBED COLOR INKJET PLOTTER

OPERATION MANUAL



- Our customer engineer or the dealers install the plotter for you.
- Be sure to setup the appropriate air-moving system as the specified ink used of this plotter contains noxious agent. When using the maintenance cleaning the ink, be sure to wear the supplied goggle and glove.

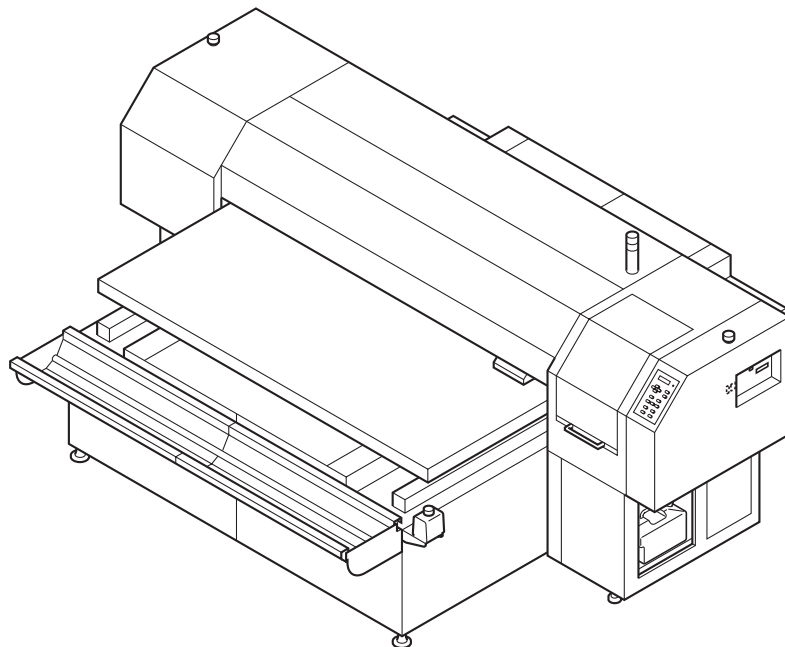

MIMAKI ENGINEERING CO., LTD.

TKB Gotenyama Building, 5-9-41, Kitashinagawa, Shinagawa-ku, Tokyo 141-0001, Japan

Phone: +81-3-5420-8671 Fax: +81-3-5420-8687

URL: <http://www.mimaki.co.jp/>

E-mail: trading@mimaki.co.jp

D201258

DISCLAIMER OF WARRANTY

THIS LIMITED WARRANTY OF MIMAKI SHALL BE THE SOLE AND EXCLUSIVE WARRANTY AND IS IN LIEU OF ALL OTHER WARRANTIES, EXPRESS OR IMPLIED, INCLUDING, BUT NOT LIMITED TO, ANY IMPLIED WARRANTY OF MERCHANTABILITY OR FITNESS, AND MIMAKI NEITHER ASSUMES NOR AUTHORIZES DEALER TO ASSUME FOR IT ANY OTHER OBLIGATION OR LIABILITY OR MAKE ANY OTHER WARRANTY OR MAKE ANY OTHER WARRANTY IN CONNECTION WITH ANY PRODUCT WITHOUT MIMAKI'S PRIOR WRITTEN CONSENT. IN NO EVENT SHALL MIMAKI BE LIABLE FOR SPECIAL, INCIDENTAL OR CONSEQUENTIAL DAMAGES OR FOR LOSS OF PROFITS OF DEALER OR CUSTOMERS OF ANY PRODUCT.

Requests

- This Manual has been carefully prepared for your easy understanding, however, please do not hesitate to contact a distributor in your district if you have any inquiry.
 - Description contained in this Manual are subject to change without notice for improvement.
-
- Generally, names and designations referred to in this Manual are trade marks or registered trade marks of the manufacturers or suppliers.

Reproduction of this manual is strictly prohibited.

Copyright © 2005 MIMAKI ENGINEERING Co., Ltd. All Rights Reserved.

FCC Statement (USA)

This equipment has been tested and found to comply with the limits for a Class A digital device, pursuant to Part 15 of the FCC Rules. These limits are designed to provide reasonable protection against harmful interference when the equipment is operated in a commercial environment. This equipment generates, uses and can radiate radio frequency energy and, if not installed and used in accordance with the instruction manual, may cause harmful interference to radio communications.

Operation of this equipment in a residential area is likely to cause harmful interference in which case the user will be required to correct the interference at his own expense.



- In the case where MIMAKI-recommended cable is not used for connection of this device, limits provided by FCC rules can be exceeded. To prevent this, use of MIMAKI-recommended cable is essential for the connection of this device.

INTERFERENCE TO TELEVISIONS AND RADIOS

The product covered by this Instruction Manual produces low radio waves while it is in operation. The product can interfere with radios and televisions if set up or commissioned under improper conditions. The product is not guaranteed against any damage to specific-purpose radio and televisions.

The product's interference with your radio or television will be checked by turning on/off the power switch of the product.

In the event that the product is the cause of interference, try to eliminate it by taking one of the following corrective measures or taking some of them in combination.

- Change the direction of the receiving antenna or the feeder of your radio/television.
- Change the installing direction of the product.
- Move the receiver away from the product.
- Use a power line for the receiver that is not shared with the product.

LASER SAFETY

This Model is certified as a Class I laser product under the U.S. Department of Health and Human Services Radiation Performance standard according to the Radiation Control for Health and Safety Act of 1968. This means that this Model does not produce hazardous laser radiation.

CDRH REGULATION

The Center for Devices and Radiological Health for the U.S. Food and Drug Administration Implement regulations for laser products. The Label shown below indicates compliance with the CDRH regulations and is labeled on the product when marketed in the United States. This Model is equivalent to Class I laser device according to CDRH Regulation.

This product complies with 21 CFR chapter I and subchapter J.

Foreword

Congratulations on your purchase of the Color Inkjet Plotter “DM3-1810S”.

DM3-1810S is the color ink jet plotter, flat type, with high speed drawing by four kinds of solvent inks.

Read this Operation Manual carefully and make the most effective use of your plotter.



- **[DM3-1810S] shifts by a high-speed head. To avoid danger of injury or damage, be sure to read this Operation Manual carefully before starting to operate it.**

On This Operation Manual

- This Operation Manual describes the operation and maintenance of the Color Inkjet Plotter DM3-1810S (hereinafter referred to as the machine).
- Please read and fully understand this Operation Manual before putting the machine into service. It is also necessary to keep this Operation Manual on hand.
- Make arrangements to deliver this Operation Manual to the person in charge of the operation of this machine.
- This Operation Manual has been carefully prepared for your easy understanding, however, please do not hesitate to contact a distributor in your district or our office if you have any inquiry.
- Description contained in this Operation Manual are subject to change without notice for improvement.
- In the case where this Operation Manual should be illegible due to destruction by fire or breakage, purchase another copy of the Operation Manual from our office.

TABLE OF CONTENTS

Foreword	i
On This Operation Manual	i
Features	vi
Safety precautions during installation	viii
Safety symbols used in manual	viii
Example of pictorials within the manual	viii
Precautions in handling the ink cartridge	ix
Never do the following	x
Precautions in use	xi
Precautions in installation	xiii
How to read this operation manual	xiv
Display on the LCD and Indication of the Keys	xiv
Structure of this Operation Manual	xv

CHAPTER 1 Before Use

Where to install the machine	1.2
Moving the machine	1.3
Configuration and function	1.4
The Front	1.4
The Rear	1.5
Operation Panel	1.6
Capping station	1.8
Ink cartridge and Ink station	1.9
Precautions in handling the ink cartridge	1.9
The prevention of organic solvent poisoning	1.10
Ink station	1.11
Types of work that can be used	1.12
Sizes of work that can be used	1.12
Precautions in handling the work	1.12
MENU mode	1.13

CHAPTER 2 Basic Operations

Operation	2.2
Switching on the power supply	2.3
Turning the power on	2.3
Turning on the blower for the absorption table	2.4
Station cover	2.5
Opening/closing the station cover	2.5
Adjusting the head height	2.6

Setting the work on the machine	2.7
Fixing the work holder	2.8
Establishing the origin and the print area	2.9
Initial value	2.9
Changing the origin and the print area	2.10
Covering in absorption holes located off the work	2.11
Checking and solving nozzle clogging	2.12
Correcting the work feed rate	2.15
Correcting the media feed rate during plotting	2.17
Plotting an image from source data	2.18
Starting the plotting operation	2.18
Interrupting the plotting operation	2.19
Displaying machine information	2.20
To replenish ink, set a new ink cartridge in the ink station	2.21
Turning the power off	2.22
Turning off the blower for the absorption table	2.22

CHAPTER 3 Daily Care

Routine maintenance	3.2
Precautions during cleaning	3.2
Cleaning fluid for maintenance	3.3
Maintenance for frame components	3.3
Cleaning the ink at the bottom of the slider	3.3
Cleaning the wiper and ink caps	3.4
Cleaning the nozzle [Nozzle Cleaning]	3.7
Cleaning or replacing the mist filter	3.10
Replacing the flushing tray ink absorber	3.11
When the waste ink tank becomes full	3.13
Ink discharge way cleaning [Drain Wash]	3.14
When not in use the machine over the long term [Storage Wash]	3.16

CHAPTER 4 How to Set Functions

Basic operations of menus	4.2
Registering a type	4.4
Changing the type	4.4
Setup functions	4.5
Change the display language [DISPLAY]	4.10

CHAPTER 5 Maintenance

Maintenance of the machine	5.2
Setting the maintenance function	5.2
Maintenance setup functions	5.3
Plotting setup conditions [LIST]	5.4
Plotting HEX CODE [DATA DUMP]	5.5
When medium thickness is changed [Print Adjust]	5.6
Cleaning the station interior [Station]-[Carriage Out]	5.8
When the message [Replace Wiper] is displayed [Station]-[Wiper Exchng]	5.9
Fill up the ink [Ink Filling]	5.11
Wiper Life warning [Wiper Level]	5.12
Displaying the firmware version [INFORMATION]	5.13
Specifying the plot head line [Use Head]	5.14
Execute the flushing and cleaning regularly [Routine Control]	5.15

CHAPTER 6 When Abnormal Conditions Are Encountered

Abnormal conditions where no error message appears	6.2
The machine cannot be energized	6.2
The machine cannot perform plotting	6.2
If image quality declines	6.3
While lines/thin spots are obvious or dark stripes occur (In the direction of travel of the head)	6.3
Characters fluctuate doubly or triply into paper feed	6.3
Displacement is observed between outward and inward plotting /The respective color ink injected by the respective color heads do not properly overlap	6.3
Large ink drop on medium	6.3
Become lighter during the printing and then plotting without ink	6.3
Some strip streaks occur on the image with narrow plot width	6.3

Problems where error messages are given on the LCD	6.4
Errors accompanied by warnings	6.4
Error messages	6.7

APPENDIX

Basic specifications	A.2
Ink specification	A.4
Consumable items	A.5
Location of safety labels	A.6
Function flowchart	A.8

Features

The features of the machine are described below. Together with the method of operation of the machine explained in this manual, they help you understand how to use the machine properly.

Newly developed high-reliability and high-coloring solvent ink

The newly developed solvent ink provides printing directly on the resin face without ink layers. This ink has a water resistance and a weather resistance.

High-Speed plotting

Eight stylish new model piezo heads stagger-arranged four rows back and forth enable high-resolution and high-speed 4 color plotting.

High-precision plotting and high-quality images

The machine is capable of plotting high-quality images with a maximum resolution of 720 dpi.

Head height adjustable to 50mm maximum

This machine can print on thick work such as board, tile, and siding.

Prints on extra wide work of 1870mm maximum

Up to 1870mm wide work can be set for printing over up to a 1860mm wide area.

Indication of the INK Remains

Since the amount of ink that remains can be checked even during operation of the machine, you can use the ink and medium without waste.

High-speed interface

The "IEEE-1394" interface allows for high-speed data reception from the computer.

Easy "origin" setting

The cross-shaped LED pointer allows easy visual setting.

Prevents the head and work collision

When the work is too thick or the head height is set too low, the head protective sensor senses the head height and avoids the head collision accordingly.

Easy maintenance

The automatic capping system allows no head-cleaning before turning off the power.

Nozzle-logging can be recovered by performing the cleaning function.

The machine automatically performs nozzle-clogging preventive operation at fixed intervals. However the main power should be left turning on.

The machine monitors the time period when not in use. When the power is turned on or when plotting is started, it automatically performs head-cleaning to prevent from clogging nozzle.

Safety precautions during installation

Safety symbols used in manual

Safety signal words

Pictorial signs are used in this Operation Manual for safe operation of and in prevention of damages to the machine. Pictorial signs and their meanings are given below. Read and fully understand before reading the text.



- Indicates a potentially hazardous condition which, if not avoided, could result in serious injury or death. Be sure to read this manual for proper operation.



- Indicates a potentially hazardous condition which, if not avoided, could result in moderate or minor injury or property damage.



- The symbol "💡" indicates helpful information that will facilitate the use of the machine.



- Indicates the reference page for related contents.

Example of pictorials within the manual



- The symbol "⚠" indicates the case where some phenomenon that requires a CAUTION sign (including "DANGER" and "WARNING" signs) exists. A concrete precaution (precaution against an electric shock in the case of the sketch given on the left) is shown in the illustration.



- The symbol "⊘" indicates a prohibited behavior. A concrete illustration of prohibition (disassembly is prohibited in the sketch given on the left) is shown in or next to the illustration.



- The symbol "●" indicates a thing that is forced to be done and instruction that is forced to be followed. A concrete illustration of instruction (the removal of a plug from the receptacle is instructed in the sketch given on the left) is drawn in the illustration.

Precautions in handling the ink cartridge



WARNING



Some specified inks for the machine contain the second kind organic solvent (cyclohexanone). Therefore, comply with [Ordinance on the Prevention of Organic Solvent Poisoning] (by Labor Ministry). (excluded ES3 ink)



HAZARDOUS

According to the Ordinance on the Prevention of Organic Solvent Poisoning, be sure to setup the local ventilation machine attached with specified functions, the push-pull ventilator, or the appropriate air-moving system.



FLAMMABLE

The ink used for this machine contains organic solvent. Since the ink is flammable, never use fire when using the machine.



When cleaning the ink station and head, be sure to wear the supplied goggle and gloves since you may get ink in your eyes.



If anyone drinks ink in mistake, keep him or her quiet and see a doctor immediately. Do not allow him or her drink vomit. Then, contact the Poison Control Center.



If you absorb a lot of vapor and feel bad, immediately move to a location where fresh air is present and then keep yourself warm and quiet. Then, consult a doctor as soon as possible.













Waste ink is equivalent to waste oil of industrial waste. Request an industrial waste processor for processing of waste ink.





















After filling up solvent ink to the machine, do not use aqueous ink even if the ink path is still cleaned. Some jells may cause some trouble such as ink clogging.

Never do the following

 WARNING	
<p>Do not disassemble or modify the machine.</p>  <ul style="list-style-type: none"> Never disassemble or remodel the main unit of the machine and the ink cartridge. Disassembling/remodeling any of them will result in electric shocks or breakdown of the machine. 	<ul style="list-style-type: none">  Store ink cartridges and waste ink tank in a place that is out of the reach of children.  If ink settles on the skin or clothes, immediately wash it off with detergent or water. If you get ink in your eyes, immediately rinse off with water and consult a medical doctor.
<p>Do not use the machine in damp places.</p>  <ul style="list-style-type: none"> Avoid damp environments when putting the machine into service. Do not splash water onto the machine. High-humidity or water will give rise to fire, electric shocks or breakdown of the device. 	<p>Handling of the power cable</p> <ul style="list-style-type: none">  Take care not to damage, break or work on the power cable. If a heavy matter is placed on the power cable, heated or drawn, the power cable can break to cause fire or electric shocks.
<p>Abnormal event occurs.</p>  <ul style="list-style-type: none"> If the machine is used under an abnormal condition where the machine produces smoke or unpleasant smell, fire or electric shocks can result. Be sure to turn off the power switch immediately and detach the plug from the receptacle. Check first to be sure that the machine no longer produces smoke, and contact a distributor in your district for repair. Never repair your machine by yourself since it is very dangerous for you to do so. 	<p>Power supply and voltage</p> <ul style="list-style-type: none">  Be sure to use the machine with the power supply specifications indicated.  Be sure to connect the plug of the power cable to a grounded receptacle. If not, fire or electric shocks can result.
<p>Handling of ink cartridges</p>  <ul style="list-style-type: none"> The ink is noxious. If ink settles on the skin or clothes, immediately wash it off with detergent or water. If you get ink in your eyes, immediately wash your eyes with a lot of clean water for at least 15 minutes. In this case, also wash the backside of eyelids to rinse ink away completely. Then, consult a doctor as soon as possible. 	<p>Laser sensor</p> <ul style="list-style-type: none">  This device is equivalent to Class I laser device according to CDRH Regulation. LASER CAUTION Label for CDRH regulation shown below is provided with the device. Also, the device is equivalent to a Class I laser device according to JIS/IEC standard. The label according to these standards shown below is provided with the device. To avoid causing pain in your eyes or visual impairment, do not review the laser beam through a lens or the other optical observation system.
	<div style="display: flex; justify-content: space-between; align-items: center;"> <div style="border: 1px solid black; padding: 2px;"> <p>CAUTION Laser radiation when open. DO NOT STARE INTO BEAM.</p> </div> <div style="border: 1px solid black; padding: 2px;"> <p>クラス1レーザー製品 CLASS 1 LASER PRODUCT</p> </div> </div>

Precautions in use

 CAUTION	
<p>Protection against dust</p> <ul style="list-style-type: none">  • It is strongly recommended to use the device in a room that is not dusty. Set the Refresh level 2 or 3 when in bad environment. ( page 4.7)  • Keep the front cover to be closed also when the machine is not engaged in plotting. If not, dust can accumulate on the head nozzle.  • When leaving the workshop after the working hours, be sure to take off any medium from the roll hanger. If any medium is left on the roll hanger, dust can put on it.  • Store medium in a bag. Wiping off dust accumulated on a medium will adversely affect the medium due to static electricity.  • Frequently clean the capping station to eliminate dust and paper chips.  • Dust in the head will also cause drops of ink to fall on the media during printing. If this phenomenon takes place, be sure to clean up the head. ( page 3.4) 	<p>Warning labels</p> <ul style="list-style-type: none">  • This machine is adhered with ten warning labels. Be sure understand firmly the warnings given on the labels. In the case where any of the warning label has become so soiled that the warning message is illegible or has come off, purchase a new one from your local distributor or our office. Refer to Appendix for the label adhering locations. ( page A.6)
Use the dedicated ink	
<ul style="list-style-type: none">  • Do not any other inks except for a dedicated ink as operation of this machine does not work under the unit protection.  • Do not use the dedicated ink for any other plotters, or the plotter may not work. 	
Periodic exchange parts	
<ul style="list-style-type: none">  • There are some parts which must be replaced by service engineer. You have to make a contract with distributors or dealers for after sale service. 	
Power supply	
<ul style="list-style-type: none">  • The breaker should be on at all time.  • Do not turn off power except for maintenance. ( page 2.3) 	
<p>Station cover</p> <ul style="list-style-type: none">  • Never open the station cover during plotting. Opening the station cover will abort plotting. 	
Keep the machine level	
<ul style="list-style-type: none">  • Adjust the level feet to keep the machine level at all times. 	

 **CAUTION**

Ink cartridges



- If the ink cartridge is moved from a cold place to a warm place, do not use for three hours.



- Open the ink cartridge just before installing it in the machine. If it is opened and not installed for a long time, the machine may not plot normally.



- Make sure to store ink cartridges in a cold and dark place.



- Be sure to thoroughly consume the ink in the ink cartridge, once it is opened, within three months. If an extended period of time has passed away after opening the cartridge tank, plotting quality would be poor.



- Using any ink type other than the exclusive one can cause a trouble. Remember that the user shall be charged for a repair cost to correct any damage resulting from the use of ink other than the exclusive type.



- The ink cartridge cannot be refilled.









- Neither pound the ink cartridge nor shake it violently so as to prevent leakage of ink.



- Do not touch or stain the contacts of the ink cartridge as doing so may cause damage to the print circuit board.

Precautions in installation

 CAUTION	
<p>A place exposed to direct sunlight</p>  <ul style="list-style-type: none"> Do not install machine where it is exposed to direct sunlight or work may be discolored. 	<p>A place that is not horizontal</p>  <ul style="list-style-type: none"> Do not place the machine where the machine can not be installed on a level surface, or you may not secure the stabilized print work.
<p>A place in which temperature and humidity vary by a great margin</p>  <ul style="list-style-type: none"> Use the machine under the following environment. <p style="margin-left: 40px;">Operating environment: 20 to 35°C 35 to 65% (Rh)</p>	<p>A place that vibrates</p>  <ul style="list-style-type: none"> Do not install the machine where it is subject to vibration or you may not secure the stabilized plot work.
<p>A place exposed to direct air blowing from air conditioner, etc.</p>  <ul style="list-style-type: none"> Do not install the machine that is directly exposed to blowing air from an air conditioner, etc, or you may get spattered with the ink. 	<p>A place full of dust or cigarette smoke</p>  <ul style="list-style-type: none"> Do not install the machine where it is exposed to significant dust or cigarette smoke, or the dust may adheres to the machine and cause the ink drops to deflect.

How to read this operation manual

Display on the LCD and Indication of the Keys

In this Operation Manual, the characters displayed on the LCD of the operation panel and the keys used to operate the machine are explained, together with the operation procedure.  page 1.6.
Operate the machine while confirming the display on the LCD.

Display on the LCD

The content of display is shown in characters in a box as shown at right.

Operate the machine according to the explanation of the operation procedure and the content of display on the LCD.

In this Operation Manual, each setting and messages displayed on the LCD is enclosed in [], like [Type1], [Please Wait], etc.

FUNCTION SETUP	< ENT >
-------------------	---------

SETUP SELECT	: Type 1
-----------------	----------

Operation keys

In the text of this Operation Manual, the operation keys are shown enclosed in brackets.

[▲] and [▼] indicate JOG keys.

The other operation keys are enclosed in brackets, as [FUNCTION].

Structure of this Operation Manual

This manual consists of the following six chapters to describe the handling of the machine.

Chapter 1 Before Use

This chapter describes the name and function of each section of the machine as well as ink and work.

Chapter 2 Basic Operations

This chapter describes a series of operations and settings, ranging from power-on to end of plotting.

Chapter 3 Daily Care

This chapter describes the daily cleaning.

Chapter 4 How to Set Functions

This chapter describes the setting function.

Chapter 5 Maintenance Functions

This chapter describes functions intended to correct adverse influences on picture quality and to check abnormal conditions as well as the procedure to be taken to replace a used wiper.

Chapter 6 When Abnormal Conditions Are Encountered

This chapter describes how to correct troubles after the occurrence of an abnormal condition on the machine.

Appendix

This appendix describes the specifications of the machine, function menu structure and introduces separately-available consumables.



CHAPTER 1

Before Use

This chapter describes the name and function of each section of the machine as well as ink and work.

Table of contents

Where to install the machine	1.2
Moving the machine	1.3
Configuration and function	1.4
Ink cartridge and Ink station	1.9
Types of work that can be used	1.12
MENU mode	1.13

Where to install the machine

Secure a suitable installation space before assembling the machine.

Install the machine considering enough space for the machine size and to perform plot operation.

Model	Width	Depth	Height	Gross weight
DM3-1810S	3070 mm	2560 mm	1350 mm	650 kg or less

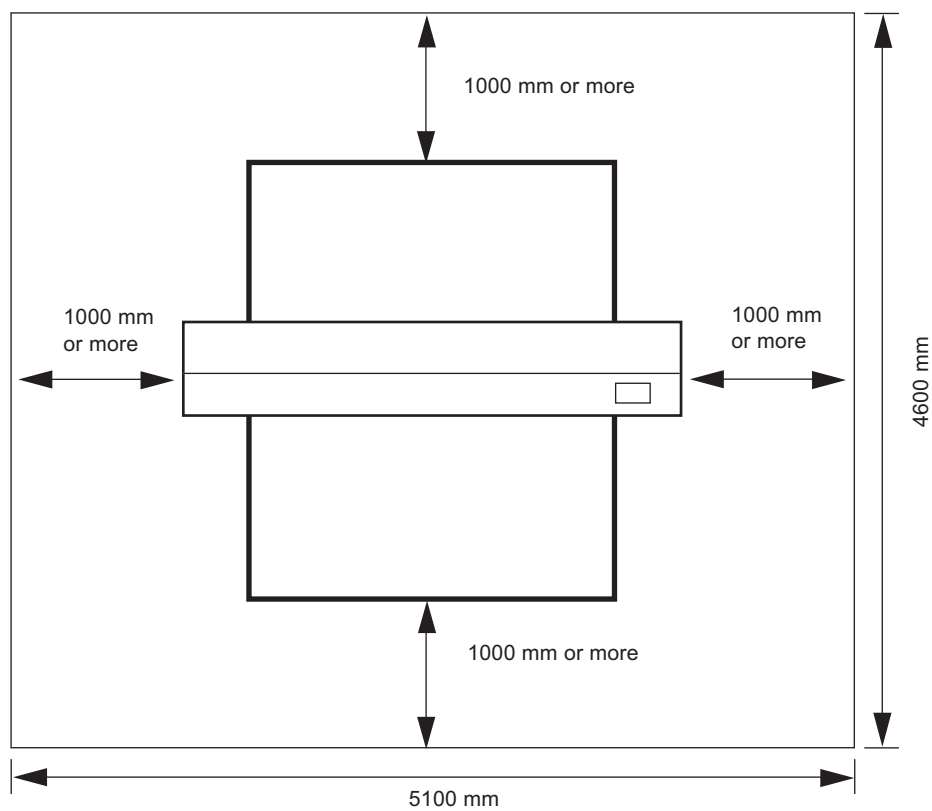

Working environmental temperature

This machine should be used at 68 – 95°F (20 – 35°C) to implement a stable plot.

The surrounding temperature condition occur different patterns.

Moving the machine

This section explains to carry the machine to e.g., an instruction location after assembled.

Raise the level feet of the table frame before moving the machine to a new location.



- **Be sure to disconnect the power cable and the interface cable before moving the machine.**
- **When moving the machine, take care not to apply excessive shock to it.**
- **Be sure to adjust the level feet to level the machine at the new location.**

Method of moving the machine

When moving the machine, it must be held up by at least eight persons as illustrated at right.

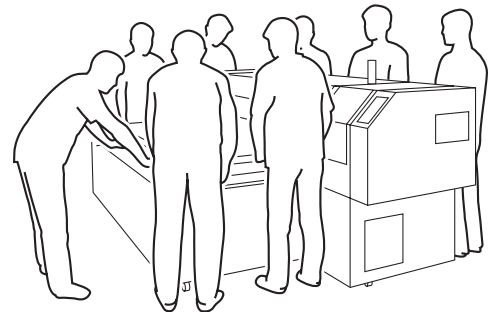

Locking the caster

Raise the level feet of the table frame before moving the machine to a new location.

Lower and adjust the level feet to level the machine at the new location.



- Use a level gauge to ensure that the table is level in the front and in the back.

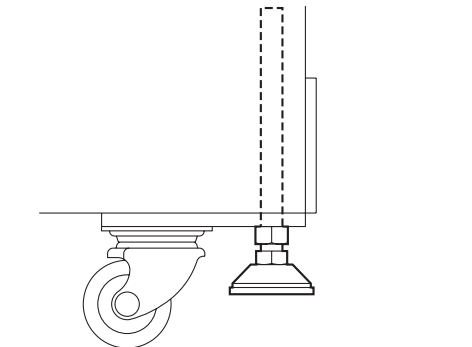

Configuration and function

The Front

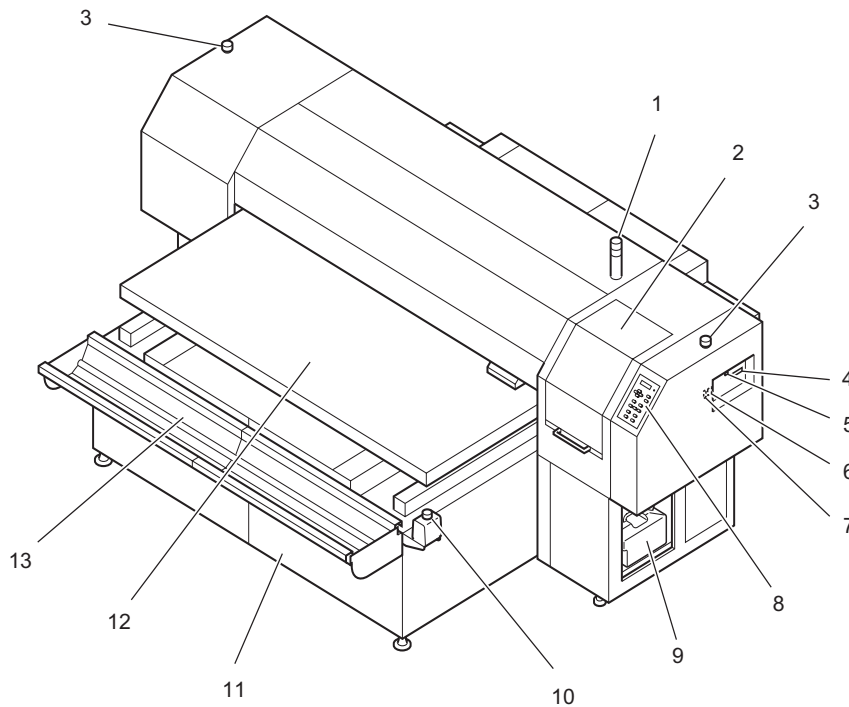

	Name	Function
1	Pilot lamp	Displays the machine status as ACTIVE (green), or ERROR (red).
2	Station Cover	A cover for the station maintenance. Open the cover when performing the station maintenance. (☞ CAPTER 3)
3	EMERGENCY Switch	(Emergency) Stop plotting.
4	Parallel connector	Bi-directional parallel interface connector. (complies with IEEE1284)
5	IEEE1394 connector	A 400 M bps interface connector compatible with -IEEE1394.
6	AC inlet	The power cable is connected to the AC inlet.
7	Power switch	It turns on/off the power to the machine. (☞ page 2.3)
8	Operation panel	This panel has the operation keys required for operating the machine and the LCD for displaying set items, etc.
9	Waste ink tank	Waste ink gathers in this tank. (☞ page 3.13)
10	Blower switch	A switch to turn the blower On/Off. (☞ page 2.4)
11	Table frame	It supports the main unit. It is provided with casters and level foots for moving the machine. (☞ page 1.3)
12	Table	Moves back and forth when performing plotting. (☞ page 2.7)
13	Roll Support	This may be used as a tray for a roll media or for a sheet for seal up the table adsorption holes.

The Rear

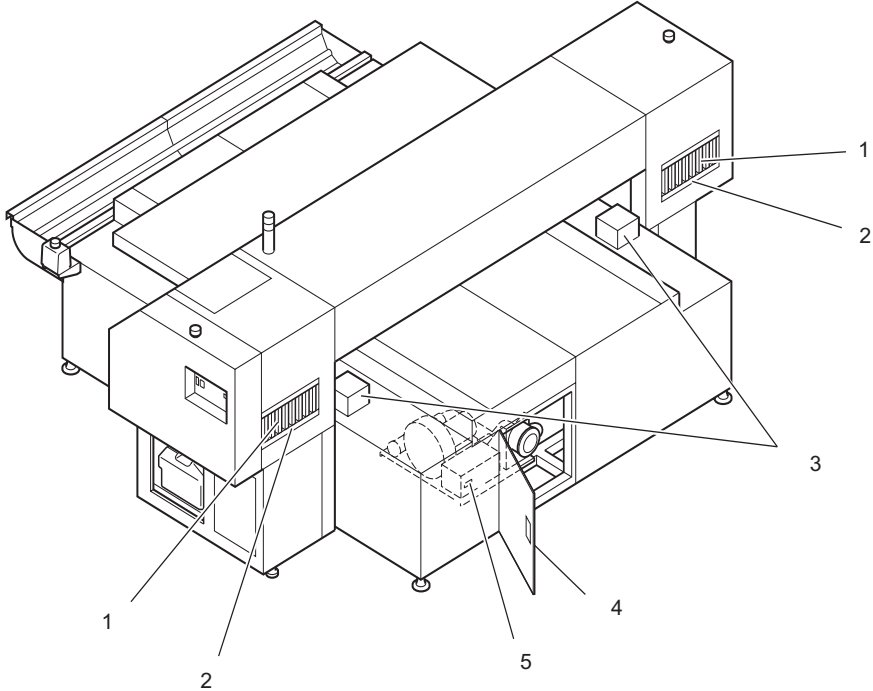

	Name	Function
1	Ink cartridge	Each cartridge contains ink of a specific color.
2	Ink station	Set the ink cartridges specified.
3	Air filter (Periodic replacement parts)	Filter out the dust or ink mist sucked the blower. (☞ page 3.10)
4	Blower door power switch	Open and close while turn On/Off the blower main power switch. (☞ page 2.4)
5	Blower main	A switch to turn the blower main power On/Off.



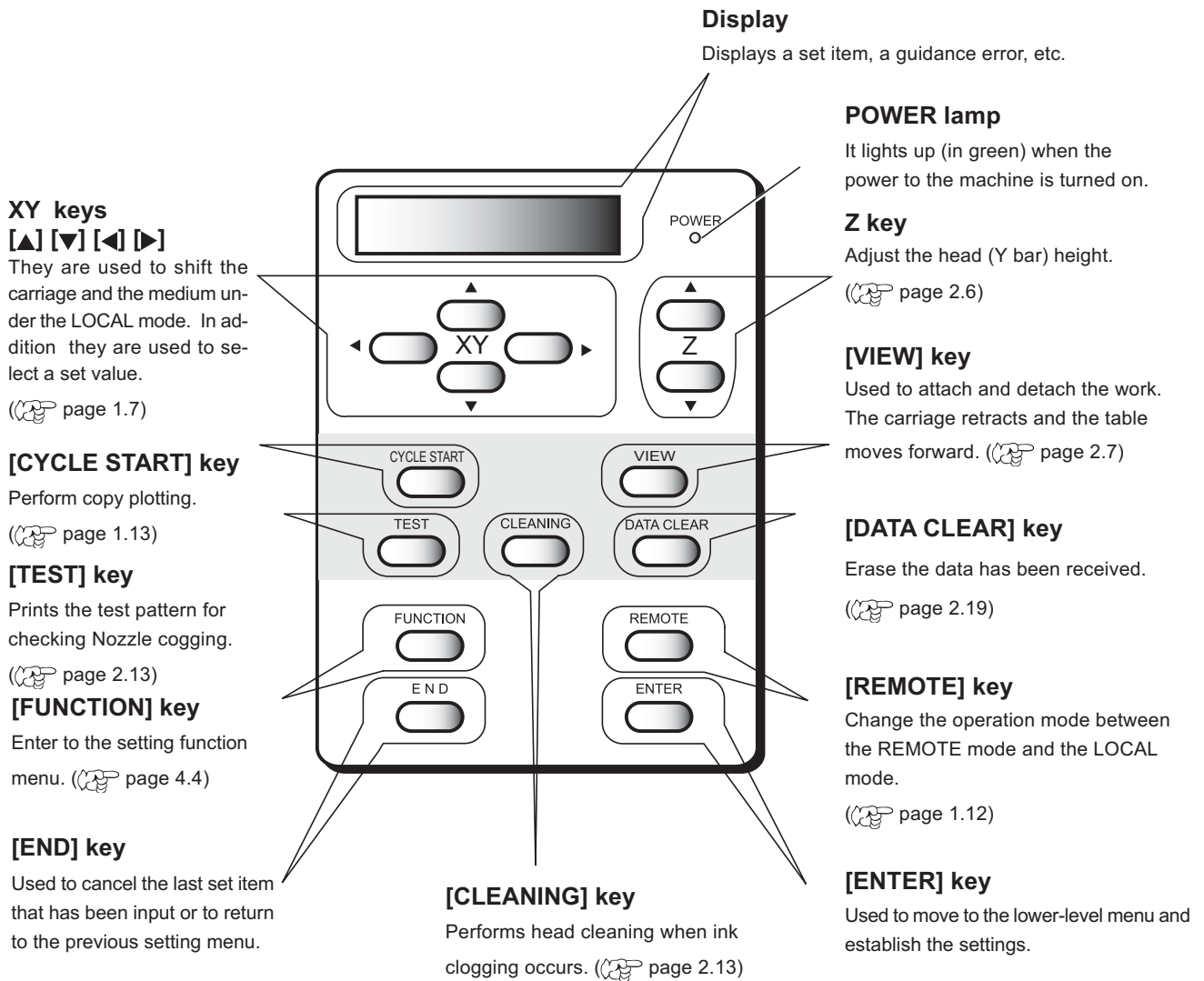

Operation Panel

The operation panel that is used to operate the machine.



Functions of the XY keys

Each of the keys varies in function according to the time at which it is used.

	When setting a plotting origin / plotting area	When selecting a function	When inputting a choice selected among several alternatives
	Shifts the carriage to the left.	_____	_____
	Shifts the carriage to the right.	_____	_____
	Shifts the work (table) away from you.	Restores the last previous function.	Selects the next value.
	Moves the work (table) toward you.	Moves to the next function.	Selects the last previous value.

Functions of the Z keys

Press the Z keys to move the head (Y bar) height. (👉 page 2.6)

Capping station



- **When cleaning the inside of the capping station, be sure to wear the goggles to prevent from getting ink in your eyes.**

The capping station consists of ink caps, wipers for cleaning the heads, etc.

Cap : It covers the nozzle so as to prevent the head nozzle from drying up.

Wiper : It is used to clean the head nozzle.

The wipers are consumable parts. If the wiper is deformed or the work is stained, replace the wiper with a new one.

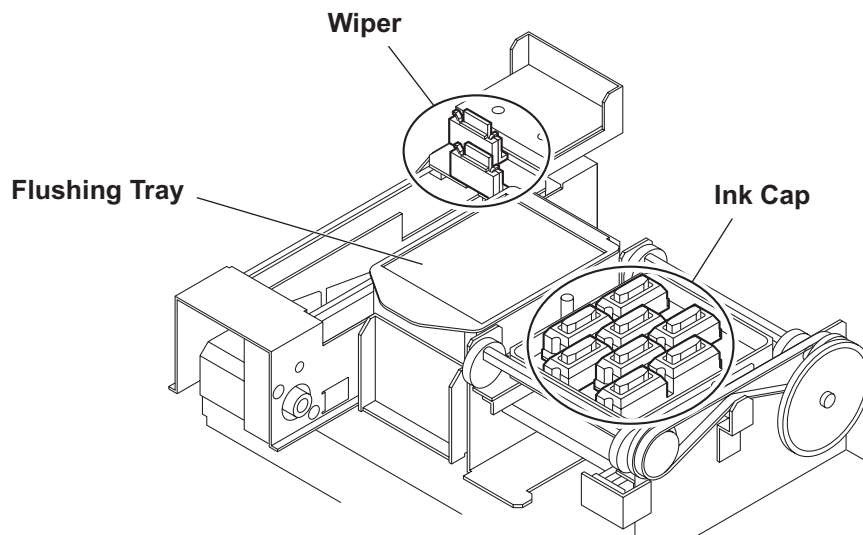

Ink cartridge and Ink station

Precautions in handling the ink cartridge



- **The ink is noxious.**

If ink settles on the skin or clothes, immediately wash it off with detergent or water.

If you get ink in your eyes, immediately wash your eyes with a lot of clean water for at least 15 minutes. In this case, also wash the back-side of eyelids to rinse ink away completely. Then, consult a doctor as soon as possible.



- **Never disassemble the ink cartridge.**



- **Do not shake the ink cartridge violently. Shaking or turning it roughly can cause leakage of ink.**



- **Never refill the ink cartridge with ink.**

MIMAKI assumes no responsibility for malfunction caused by using the machine after replenishment of ink.



- **The ink cartridge cannot be refilled. Refilling the ink cartridge can cause a trouble. Remember that MIMAKI assumes no responsibility for any damage caused by the use of the ink cartridge replenished with ink.**



- **Do not touch or stain the contacts of the ink cartridge as doing so may cause damage to the print circuit board.**



- **If the ink cartridge is moved from a cold place to a warm place, do not use for three hours.**



- **Be sure to thoroughly consume the ink in the ink cartridge, once it is opened, within six months. If an extended period of time has passed after opening the cartridge tank, plotting quality would be poor.**



- **Be sure to store ink cartridges in a cold and dark place.**



- **Store ink cartridges in a place that is out of the reach of children.**



- **Request an industrial waste processor for processing of empty cartridges.**

The prevention of organic solvent poisoning

Organic solvent is enough evaporable to melt fat and to be absorbed into respiratory organ or skin. It affects on the organs or central nerve, and causes acute intoxication and chronic intoxication. To prevent from organic solvent poison, carefully observe the following matters.



- **Be sure to setup the appropriate air-moving system.**
- **Be sure to check periodically on the air-moving system.**
- **Indicate precautions of danger on the human body by organic solvent.**
- **Be sure to perform the environmental measurements every six months. (The environmental measurements and the organic solvent density measurements performed by the working environment measurement expert.) Improve the result of the environmental measurement.**
- **Be sure to get a medical checkup every six months.**
- **Be sure to take the organic solvent work chief person skill training.**

Ink station

The Right ink station supplies ink to the 2 front row of Carriage.

The Left ink station supplies ink to the 2 rear row of Carriage.

Remember these relationship when checking the heads for clogged nozzles, replacing ink cartridge and replenishing inks.

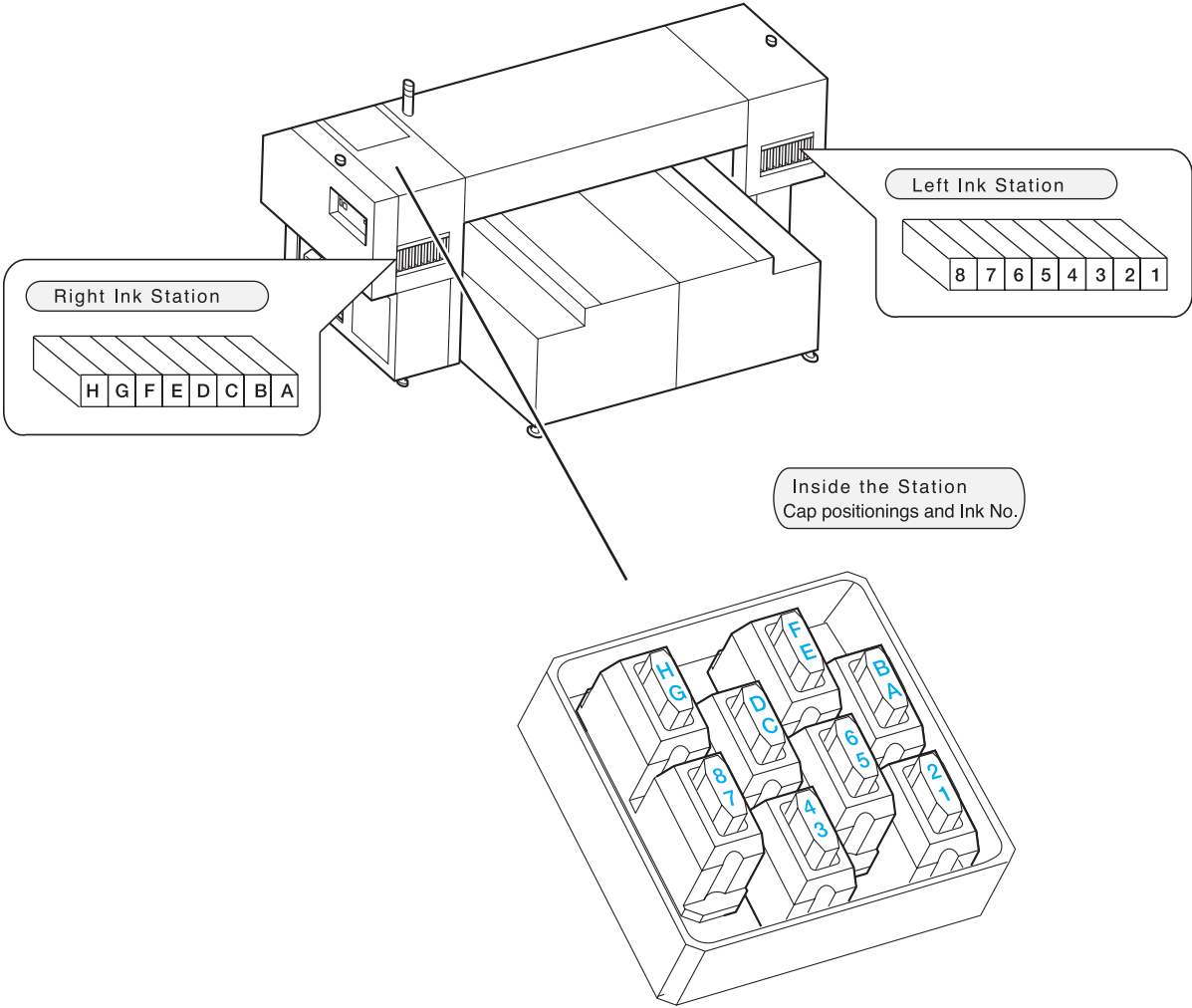

Types of work that can be used

The following describes the sizes of work that can be used and the method of handling.

Sizes of work that can be used

Maximum	1870 mm
Minimum	1050 mm
Max. plotting width	1860 mm
Max. plotting length	1010 mm
Thickness	50 mm or less
Weight	60kg or less when load is evenly distributed

Precautions in handling the work

Carefully observe the following when handling the work.



- **Work thickness**

When setting the work used, adjust the head height. Otherwise, the work and/or the head can be damaged.



- **Expansion and contraction of the work**

Do not use sheet types of work immediately after unpacking. The work can expand and contract due to room temperature and humidity. The work have to be left in the atmosphere in which they are to be used for 30 minutes or more after unpacked.



- **Warps of work**

Use a flat work, and a warped-down work (its center is arched) with the plotting surface up. The warped-up work is an unabsorbable to the table. As for a warped-up work, place them to a smaller board or a pallet to keep it warped down.



- **Improvement of the solvent ink fixation**

If the work is warmed up to 40°C and more, the capability of ink fixation can be improved.



- **Using the absorption table**

To maintain absorption effect, cover in all absorption holes on the table which the work does not cover in.



- **Other tips (With the table unit)**

- Do not place anything matter on a coated paper. To prevent discoloration of a coated paper.
- The machine has a moving table. Do not use an unabsorbable curled work or a loose media during table operating. If necessary, fix the work with a tape.

MENU mode

The unit's four modes are described below.

< LOCAL > mode

This mode is for the preparatory state.

All keys are effective to enable setups.

The machine is able to receive data from computer, however, it will not perform plotting.

In this mode, it is possible to perform the following operations.

1. Pressing the appropriate XY keys to set up an origin and the printing area.
1. Pressing the Z keys to set up the print head (Y bar).
2. Pressing the [TEST] key to start test printing.
2. Pressing the [CLEANING] key to start cleaning the print head.
3. Pressing the [DATA CLEAR] key to erase the plotting data the machine has received.
4. Pressing the [FUNCTION] key to set plotting conditions.
5. Pressing the [VIEW] key brings the work to the detaching position.

< REMOTE > mode

The machine plots an image from data it receives.

During the plotting operation, press the [REMOTE] key to interrupt the plotting operation.

While the machine is in the LOCAL mode, press the [REMOTE] key to put the machine into the REMOTE mode.

< CYCLE START > mode

This mode may be used in combination with "Raster Link Pro" to repeat plotting using the identical data (copy). "Raster Link Pro" has a copy function which eliminates the need to send data from the computer for every plotting.

While the machine is in the LOCAL mode, press the [CYCLE START] key to put the machine into the CYCLE START mode.

- When ES3 ink is filled, use this mode after installing ES3 profile.

< FUNCTION > mode

While the machine is in the LOCAL mode, press the [FUNCTION] key to put the machine into the FUNCTION mode.

This is the mode in which plotting conditions can be set.



CHAPTER 2

Basic Operations

This chapter describes a series of operations and settings, ranging from power-on to end of plotting.

Table of contents

Operation	2.2
Switching on the power supply	2.3
Station cover	2.5
Adjusting the head height	2.6
Setting the work on the machine	2.7
Establishing the origin and the print area	2.9
Covering in absorption holes located off the work	2.11
Checking and solving nozzle clogging	2.12
Correcting the work feed rate	2.15
Correcting the media feed rate during plotting	2.17
Plotting an image from source data	2.18
Displaying machine information	2.20
To replenish ink, set a new ink cartridge in the ink station	2.21
Turning the power off	2.22

Operation

The following shows a series of operations and settings, ranging from power-on to end of plotting.
For details on each item, refer to the reference page.

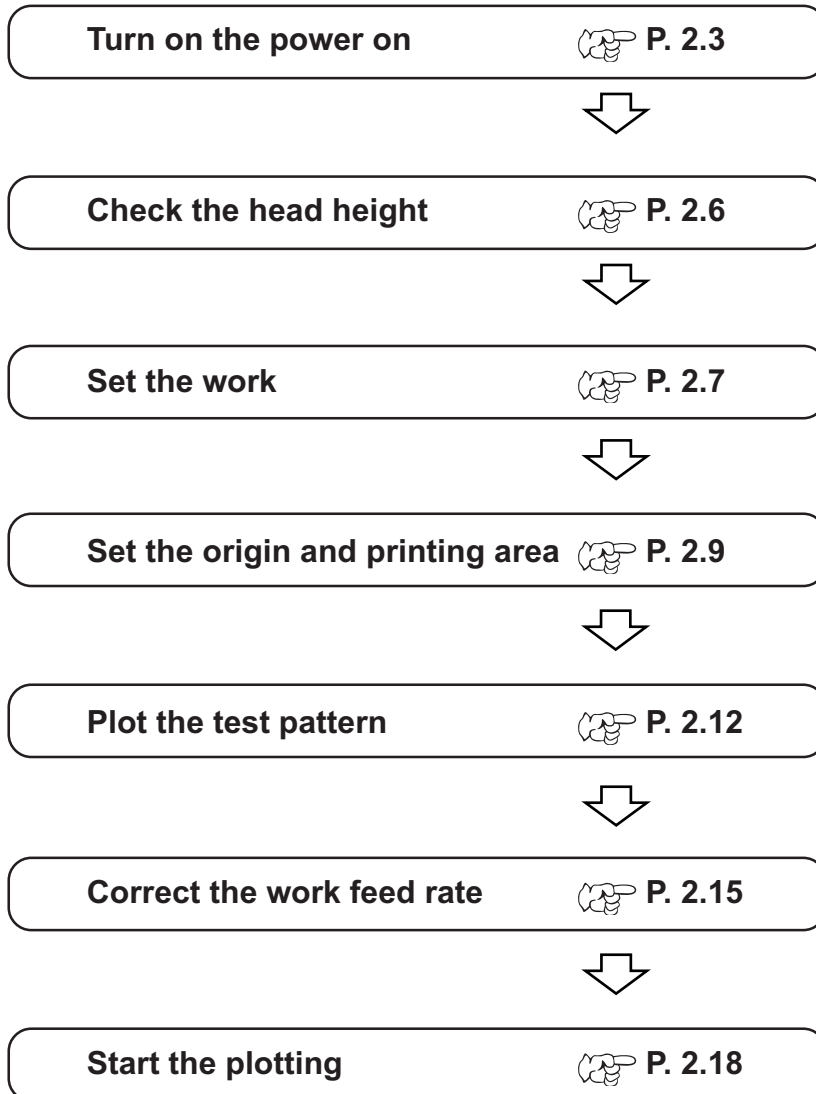

Switching on the power supply

Turning the power on

1. Turn on the power to the machine.

Press the power switch to "I".



- Make sure that the station cover is closed. If it is open, initialization is not performed.
- Leave 10 seconds and more intervals before turning on the power after once turning off.

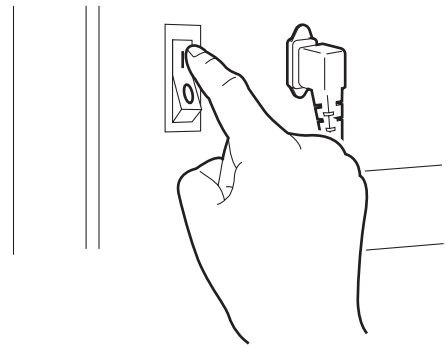

When the power is switched on, the LCD first displays "BOOT" and then displays the firmware version number.

2. The message [Please Wait] appears flashing on the LCD.

The initial operation of the machine is performed.



- To avoid injuries, keep your hands away from the machine while in motion.
- To prevent from clogging nozzle, normally do not turn off the power. When the power is turned off for maintenance works, the nozzle clogging preventative function operates according to the time off.

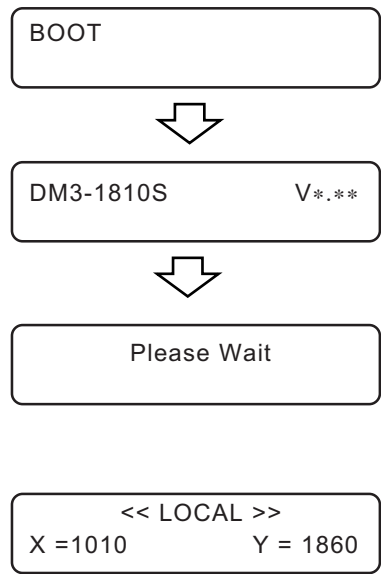

3. The machine enters the LOCAL mode.

Display the print area.



- The Local mode is not available until ink initialization is completed. Install the ink cartridges. (Refer to page 28 of the setup guide.)
- The following message will appear when the ink cartridges are not installed:

Ink Cartridge
1 2 3 4 5 6 7 8 A B C D E F G H

4. Turn on the power to the computer which is connected to the machine.

Turning on the blower for the absorption table

1. Open the blower door.
2. Press the blower power switch to [I].

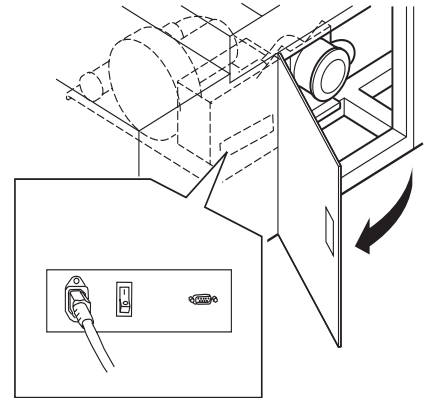

3. Press the power switch once.
(The switch light turns on.)
The blower turns on and ready for atmospheric absorption.

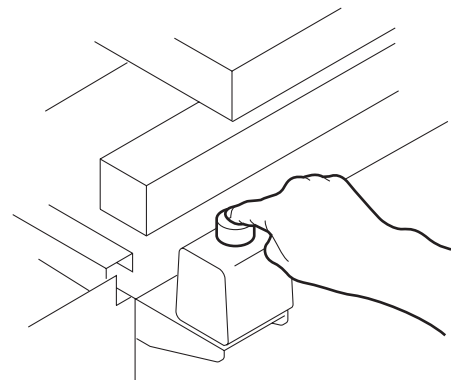

- During the **CYCLE START** mode, the blower automatically turns off when the plotting operation is completed and the table returns to the position which media is taken off.

Station cover

Opening/closing the station cover



- **Keep the station cover closed during plotting operation. Opening the station cover during plotting interrupts image printing and disables continuous processing.**

If you open the station cover during printing, the carriage will stop for safety, resulting in abortion of plotting. In this case, re-start the machine and computer following the procedure described below.

STEPS:

- 1. When opening the station cover during plotting, the message shown on the right will be displayed.**

Stop the plotting.

Check Stop SW or
Station Cover

- 2. Stop the data transmission from the computer.**

- 3. Close the station cover.**

PRESS < ENT > KEY

- 4. Press the [ENTER] key.**



Please Wait

- 5. The carriage will start to move.**

The carriage will carry out a series of performance same as that taken after turning on the power to the machine.

 page 2.3)

Adjusting the head height

The head can be adjusted in height, according to thickness of a work used for plotting. The head height must be set according to the work thickness. If the head height is too low, it may affect the plotting quality and even damage the work or the machine itself. Be sure that the head height is correct



- **Adjust the head height before setting a work on the machine.**
- **Leave at least 3mm clearance when plotting on T-shirts or other fluffy materials. Otherwise, the head will touch the fluff and affect the print quality.**



- **Confirm the head height setting value, press the [ENTER] key in the LOCAL, REMOTE and CYCLE mode. (👉 page 2.20)**

STEPS:

1. The machine enters the LOCAL mode.

Press the [REMOTE] key and put the machine back into the LOCAL mode.

```
<< LOCAL >>
X =1010      Y = 1860
```

2. Press the Z [▲] or [▼] keys to adjust the head height.

The ideal head height is equal to the work thickness + 1.0 to 2.0mm. Check the work thickness before adjusting the head height.

▲
Head Height
* * . * mm
▼



- **If the work thickness is not uniform, use the work thickness at the thickest point.**

3. Press the [ENTER] key.

ENTER
Head Height
* * . * mm

4. The machine revert the LOCAL mode.

```
<< LOCAL >>
X =1010      Y = 1860
```

Setting the work on the machine

Set the work on the table as following.



- Adjust the head height before placing a work on the machine. (☞ page 2.6)
- To maintain absorption effect, cover in all absorption holes on the table which the work does not cover in. (☞ page 2.11)
- Use a flat work, and a warped-down work (its center is arched) with the plotting surface up. The warped- up work is unabsorbable to the table. (☞ page 1.12)
- Use some tape together if the air absorption function is unable to fix some work.

STEPS:

1. Turn on the power to the machine.

<< LOCAL >>
X =1010 Y = 1860

2. Adjust the head height. (☞ page 2.6)

After adjusting, return to the LOCAL mode.

Head Height
* * . * mm

3. Press the [VIEW] key.



VIEW
< ENT >

4. Press the [VIEW] key or the [ENTER] key.

The table moves toward you.



* * VIEW * *

5. The machine reverts to the LOCAL mode.

<< LOCAL >>
X =1010 Y = 1860

6. Set the work on the marking on the table.



Secure work in such a manner that work can not float or be dislocated.

Fixing the work holder

When fixing the warped-up work (at two or four arched edges) in the allowable size (1870 x 1050 mm maximum), use the work holders on the four table edges.

STEPS:

1. Turn (or remove) the knob screws to loosen the work holder.

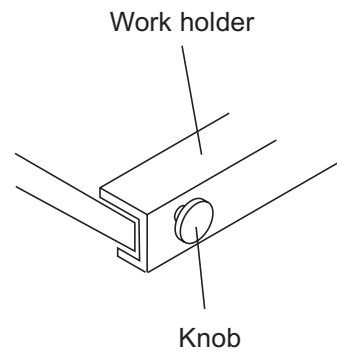
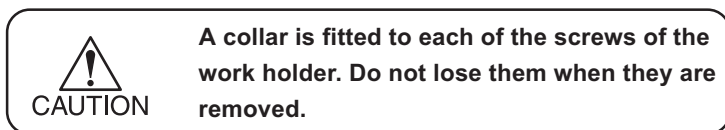

2. The right and left work holders may be turned upside down as needed according to the work size.

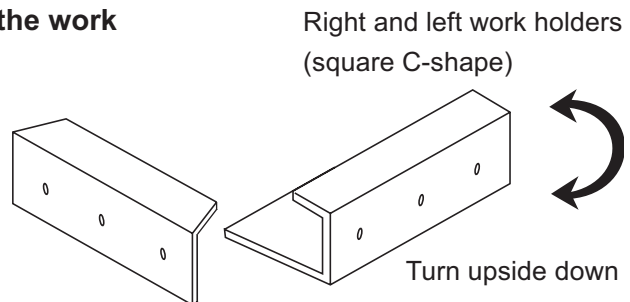

Front and back work holders (L-shaped; cannot be turned upside down)

3. Place the work between the work holder and the table.

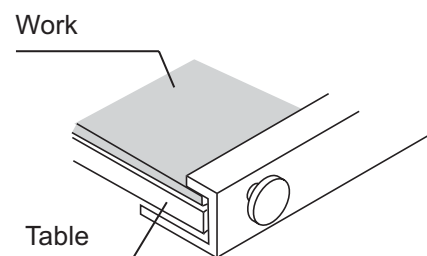

4. While pressing the work holder down, retighten the knob screws.

Establishing the origin and the print area

Initial value

The origin and the print area are set as follows by default until they are changed:

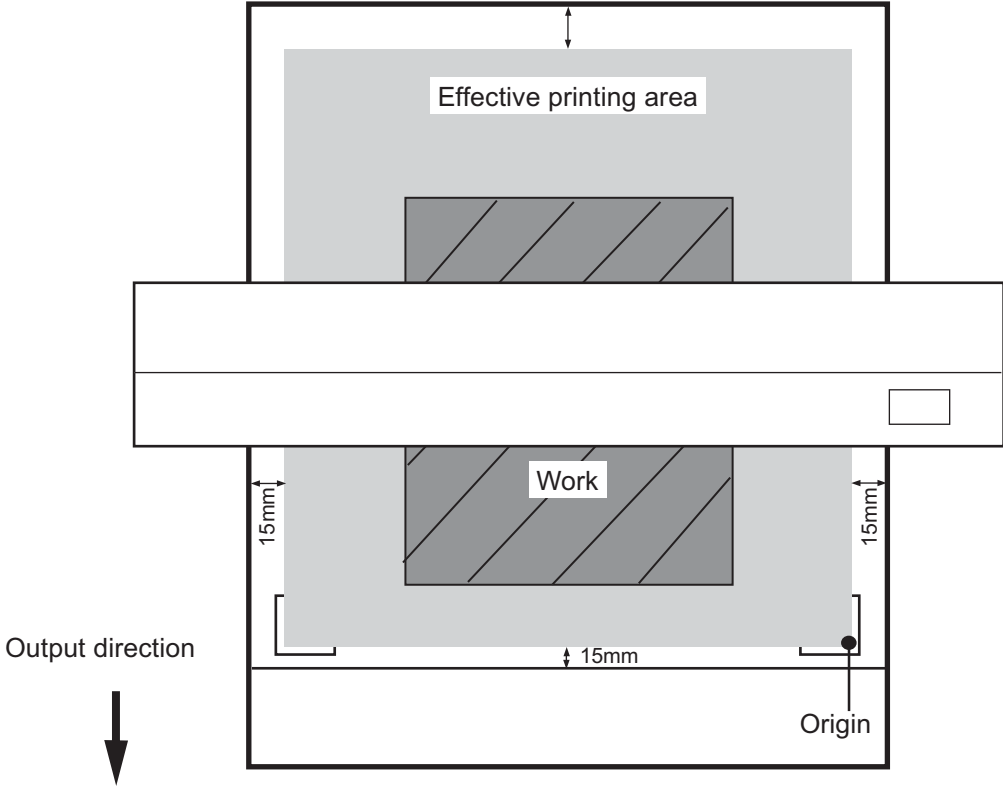

Changing the origin and the print area

The default origin and the print area may be changed as needed.



- When plotting on the entire work surface (without margins), the plotting origin and the printing area must be set outside of the work. They must be set as close to the work as possible, however, to minimize smearing the machine itself. Otherwise, there will be much ink mists especially when plotting on thick works.

STEPS:

1. The machine enters the LOCAL mode.

<< LOCAL >>
X = 1010 Y = 1860

2. Move the carriage to the position at which to establish an origin by pressing the XY[▲], [▼], [◀] or [▶] keys.

Origin Setup
X = 500 Y = 970

The origin changes as the carriage moves.



- A cross-shaped point mark appearing on the table or the work will be the display coordinate.

3. After deciding the origin, press the [ENTER] key.



Origin Setup
* * * * Origin * * * *

4. Press the [ENTER] key.

Press the [END] key if the print area is to be left unchanged.



Print Area
end < > ent

5. Set the print area by pressing the XY[▲], [▼], [◀] or [▶] keys.

Display the new print area determined by the carriage movement.

Print Area
X = 990 Y = 1810

6. After deciding the print area, press the [ENTER] key.



<< LOCAL >>
X = 990 Y = 1810

The machine revert the LOCAL mode.

The new print area is displayed.



- The new setting is saved until the origin or the print area is changed.
- The plot area will be set to the initial value if it is set to the same position as the origin.

Covering in absorption holes located off the work

According to work's size, some media do not cover in all absorption holes on the table.

The function of work absorption has effect more when the holes located off the work also get covered on the table.

Cover in the holes by sheets such as papers and films as needed.



- **Use a roll support for a rolling work and a roll sheet for the absorption holes located off the work.**



- **To prevent ink sucked by absorption holes, cover in the absorption holes in the plotting area when setting up the plotting area located off the work.**

Checking and solving nozzle clogging

Make test plotting to check whether there is nozzle clogging or other plotting failures.
If the finished test pattern shows any sign of abnormal conditions, carry out the cleaning function.



- To perform the test plot on a cut sheet medium, use a medium whose size is A4 or larger with placed in landscape configuration.

Test Pattern

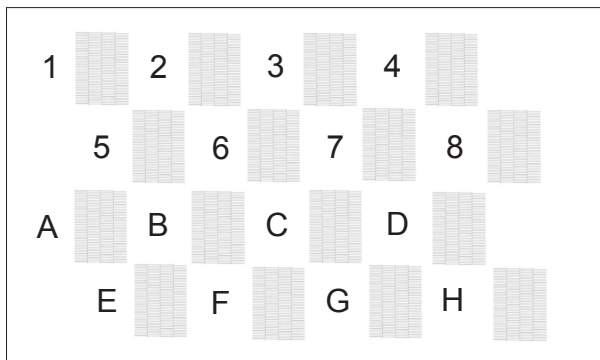

↓ Output direction

Normal Pattern

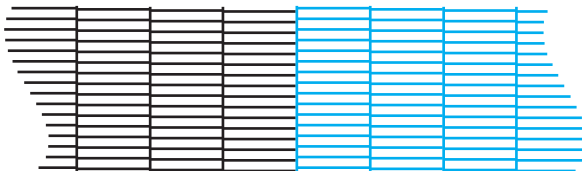

Abnormal Pattern

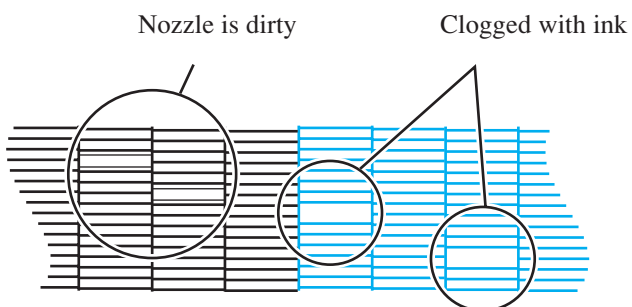

STEPS:

1. The machine enters the LOCAL mode.

<< LOCAL >>
 X =1010 Y = 1860

2. Press the [TEST] key.



TEST PRINT
 < ENT >

3. Press the [TEST] key or [ENTER] key.

The machine plots the test pattern.



** PRINT **

After the test print is done, the table moves to the front and turns to LOCAL mode.

<< LOCAL >>
 X =1010 Y = 1860

4. Check the test patterns.

Operation is completed in normal cases.

If a failure occurs, perform the following operation

5. Press the [CLEANING] key.



6. Press the XY keys [◀] or [▶] to select the head block for cleaning.

(Refer to page.1.10 [Ink station])



Clean	: 1 2 5 6 3 4 7 8
Select	: ABEFCDGH
[1256ABEF] / [3478CDGH]	

7. Press the XY [▲] or [▼] keys to set on/off of the blocks that need cleaning.

Do not execute the head cleaning as for [-----].



Clean	: 1256 -----
Select	: ABEF -----
On / Off	

8. Press the [ENTER] key.



9. Press the XY [▲] or [▼] keys to select the type of cleaning.

Cleaning	
Type	: Normal
Normal/Soft/Strong	

- Normal** : Select this if there is any missing line.
- Soft** : Select this if any line is bent.
- Strong** : When printing trouble is not solved even with [Norma]l or [Soft].

-
- 10. Press the [ENTER] key.**
It displays the remaining run-time.

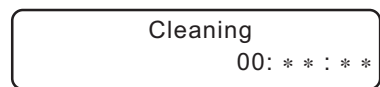

- 11. The machine revert the LOCAL mode.**



- 12. Change the work, or establish the new origin.**

- 13. Repeat steps 2 and 3, and check the result of the test printing.**

Repeat STEPS 2 to 10 until normal plotting result is obtained.



- **Replace the wiper and the ink cap if inferior printing does not improve after cleaning operations. (👉 page 3.4)**

Correcting the work feed rate

When the work type is changed, the amount of work feed changes.
If the correction value is not appropriate, stripes may occur in the plotting, disturbing neat plotting.
Correction for the work feed rate in online is available. (☞ page 2.17)

CORRECTING PATTERN

Plot two bands.
Adjust the plot density so that the boundary of the two bands is plotted with an even density,
Setting value : -100 – 100

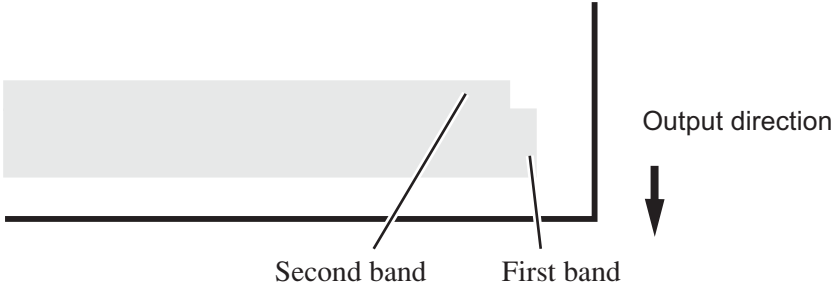

Correction value is too large

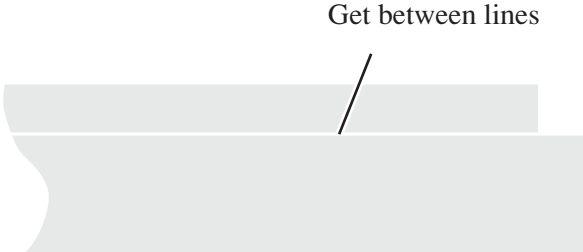

Correction value is too small

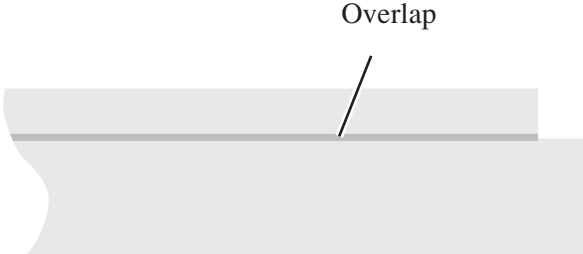

STEPS:

1. The machine enters the LOCAL mode.

<< LOCAL >>
X =1010 Y = 1860

2. Press the [FUNCTION] key.

FUNCTION
 << LOCAL >>
X =1010 Y = 1860

3. Press the [ENTER] key.

ENTER

4. Press the XY [▲] or [▼] keys to select a type.



▲

 FUNCTION
SELECT : TYPE1

5. Press the [ENTER] key.

ENTER
 TYPE1
Print Mode < ent >



6. Press the XY [▲] or [▼] keys to select [Feed Comp.].

▲

 TYPE1
Media Comp. < ent >

7. Press the [ENTER] key.

ENTER



8. Press the XY [▲] or [▼] keys to enter the plotting width.

▲

 TYPE1
Print : Y = 100

9. Press the [ENTER] key.
Output the pattern.

ENTER
 * * Printing * *
Please Wait

10. Check the patterns.
Enter a correction value from the output pattern.

ENTER
 TYPE1
Adjust = 0



- When [ADJUST] is changed to 30, the pattern moves by about 0.1 mm. Determine the correction value referencing this amount of movement.

11. Press the [ENTER] key.
Register the correction value.
Repeat steps 8 to 11 until normal plotting result is obtained.

ENTER
 TYPE1
Print : Y = 100

12. Press the [END] key three times, and the menu returns to the LOCAL mode.

END
 << LOCAL >>
X =1010 Y = 1860

Correcting the media feed rate during plotting

To perform this operation during LOCAL mode, refer to the “Feed Correct”( page 2.15).

The following describes the procedures to alter the media feed rate during plotting or in a REMOTE mode.

STEPS:

1. Press the [REMOTE] key.



2. Press the [FUNCTION] key to confirm the current setting value.

Press the [END] key when an appropriate value is set or to abort the operation.



3. Press the [ENTER] key.

Available to alter the medium feed rate.



4. Press the XY [▲] or [▼] keys as needed to set the amount of correction.

Setting value is available from -100 to +100. Press the [END] key to return to the REMOTE display. The altered value ceases to be in effect, and returns to the previous value.



- A new value takes effect in real time. The best effect can be obtained while checking the result.
- The unit of the correction value is the same as in “Feed Correct” in the LOCAL mode. ( page 2.15)
- Setting value is to be Reset as follow,
 - *Perform the Feed Correct.
 - *Perform the Setup reset

5. Press the [ENTER] key.

Confirm the medium feed rate before saving it. Press the [END] key to return to the REMOTE display. The changed setting value is to be in effect performing till the next power on.

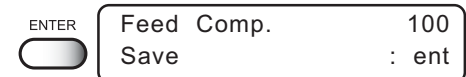

6. Press the [ENTER] key to return to the REMOTE display.

The changed setting value is saved. The value is to be in effect performing till Reset.



Plotting an image from source data

Starting the plotting operation

The following describes the method of plotting.

For various function settings necessary for plotting, refer to “CHAPTER4 How to Set Functions”.

STEPS:

1. The machine enters the LOCAL mode.

```
<< LOCAL >>
X =1010      Y = 1860
```

2. Press the [REMOTE] key.

The machine enters the REMOTE mode.



```
< REMOTE >   TYPE *
X=1010       Y=1860
```

3. Transmit data from the computer.

The plotting conditions that have been set for the data are displayed.

```
< REMOTE >
360 x 360 / 4P / U
```

For the method of data transmission, see the manual for the output software.

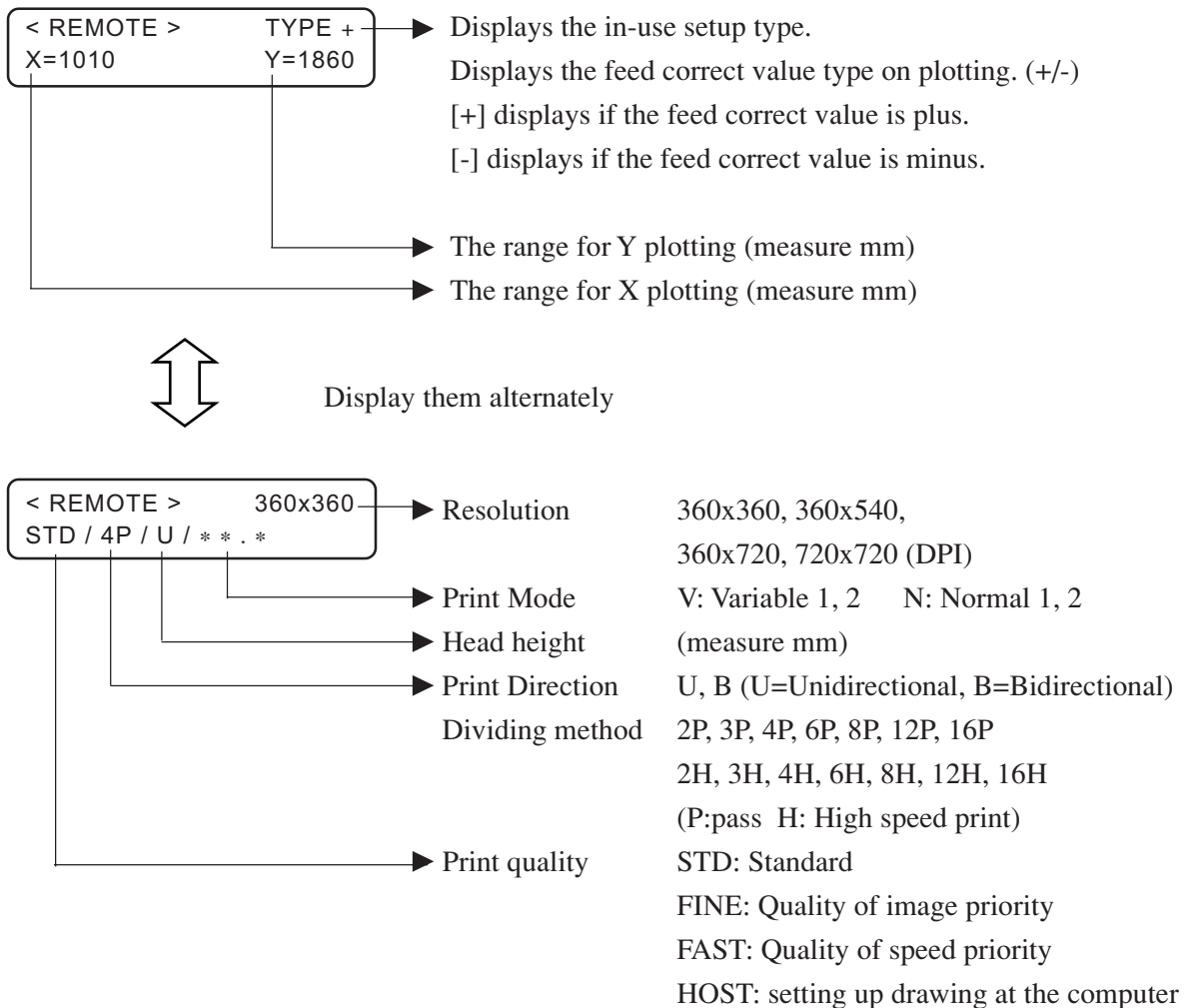

4. During the plotting.

<< LOCAL >>
X = 1010 Y = 1860

5. After the plotting operation is completed, put the machine back into the LOCAL mode.

The table will move toward you when plotting in the Cycle Start mode.



- The origin and the print area remain unchanged after plotting. You must reset them if they need to be changed. (page 2.9)

Interrupting the plotting operation

To interrupt the plotting operation, stop the carriage and erase (the receive data) from the machine.

STEPS:

1. Press the [REMOTE] key to stop the plotting operation.



<< LOCAL >>
X = 1010 Y = 1860

2. If data is being transmitted from the computer to the machine, stop the data transmission.

3. Press the [DATA CLEAR] key.

The data that has been received is erased.



DATA CLEAR < ENT >

4. Press the [DATA CLEAR] key or [ENTER] key.

The machine enters the LOCAL mode.



<< LOCAL >>
X = 1010 Y = 1860



- The green pilot lamp indicates that there is no data in the machine.

Displaying machine information

Displays the firmware version, ink level etc. This following describes the procedures to display the machine information during plotting or REMOTE and CYCLE mode.



- In LOCAL mode, information displays by pressing [ENTER] key as well.

STEPS:

1. Display the LOCAL mode.

```

<< LOCAL >>
X =1010      Y = 1860
    
```

2. Press the [REMOTE] key.

The machine enters the REMOTE mode.



```

<REMOTE>
X=1010      Y=1860
    
```

3. Press the [ENTER] key to display the ink remains.



```

      Ink Level
3 2 3 1 7 9 8 7 4 5 9 9 0 2 5 3
    
```

4. Press the [ENTER] key to display the head height.



```

      Head Height
      * . * mm
    
```

5. Press the [ENTER] key to display the ink type.



```

      Ink Type
Type          :Sol
    
```

6. Press the [ENTER] key to display the firmware version and command.



```

Ver1.00      MRL-IIC
    
```

7. The [ENTER] key displays setting status.

The [▼] key displays the in-use setup contents.



```

SETUP < TYPE * >
Display [▼] Key
    
```

8. The [ENTER] key displays error information guidance.

The [▼] key displays current warning.



```

      Error Info
      Display [▼] Key
    
```

9. Press the [END] key, the machine returns to the REMOTE or CYCLE mode.



```

<REMOTE>      TYPE *
X=1010      Y=1860
    
```



- Return to the REMOTE mode or CYCLE mode automatically when the 60 seconds pass over or error is occurred.

To replenish ink, set a new ink cartridge in the ink station

If ink in the cartridge comes to an empty, the corresponding message appears.

Plotting can be continued but ink may run out during plotting.

Immediately put a new ink cartridge.

< When the amount of ink becomes small during plotting >

Indicate the ink color which has run out.

The display at right indicates that [slot1] and [slotA] comes to an end.

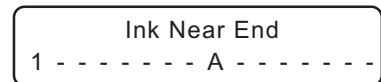

< When the amount of ink completely runs out during plotting >

Indicate the ink color which has completely run out.

The display at right indicates that [slotC] runs out.

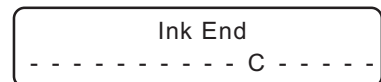

STEPS:

1. **Either of the messages shown above is displayed on the LCD during plotting.**

When [INKnearEND] appears, the local mode is resumed and the operation stopped each time plotting of a single data is completed. Proceed with Step 2 at the end of the plotting operation. Proceed to Step 2 at the end of the plotting operation.

When [INKEND] appears, plotting cannot be continued.

2. **Install a new ink cartridge.**

Pull out the ink cartridge of the indicated number and then set a new ink cartridge.

3. **The machine enters the LOCAL mode.**

Continuous plotting is possible.

Information of the remaining ink

This information allows you to check the remaining amount of ink.

STEPS:

1. **Press the [ENTER] key in the LOCAL mode.**

The remaining amount of ink is displayed with a number from 1 to 9.

1 indicates near end and 9 full.

2. **Press the [ENTER] key again.**

If the ink cartridge is defective, the error details are displayed.

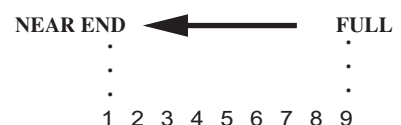

Turning the power off



- **Normally do not turn off the power**
To ensure stability of ink flushing, the device should be flushed regularly the small amounts of ink. Leave the power turned on and do not remove a plug even when the device is not in use for a prolonged period of time. The small amounts of ink should be flushed regularly regardless of the device condition. (REMOTE mode, LOCAL mode)
- **Maintenance with the power turned off**
Do not leave the power turned off for more than one hour. If the power is turned off for more than 5 days, the ink flushing does not work. (There is no problem caused if the power of the blower is turned off.) To prevent from pressing the switch, the parts of power switch is covered on. Remove the cover when the power is tuned off.
- **Make sure that the head in the capping station**
If the power is turned off while the machine is engaged in plotting, the head may fail to be retracted in the capping station. If the head is left without capped for an extended period of time, the nozzle will be clogged with dust. If the power to the machine is turned off without the head capped, return on the power to the machine.

1. Turn off the power to the computer which is connected to the machine.
2. Turn on the power to the machine.
Press the power switch to [O].

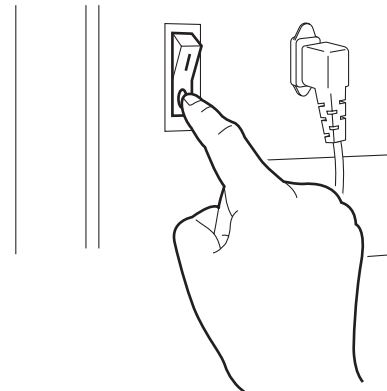

Turning off the blower for the absorption table

1. Press the VACUUM switch once.
(The switch light turns off.)
The blower turns off.

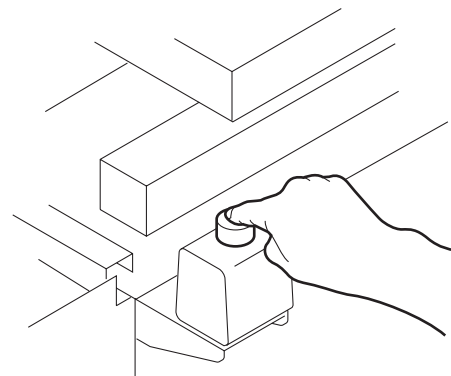

CHAPTER 3

Daily Care

This chapter describes daily cleaning.

Table of contents

Routine maintenance	3.2
Cleaning the wiper and ink caps	3.4
Cleaning the nozzle [Nozzle Cleaning]	3.7
Cleaning or replacing the mist filter	3.10
Replacing the flushing tray ink absorber	3.11
When the waste ink tank becomes full	3.13
Ink discharge way cleaning [Drain Wash]	3.14
When not in use the machine over the long term [Storage Wash]	3.16

Routine maintenance

Be sure to conduct maintenance works for the machine when necessary or periodically so as to use the plotter for a long time while keeping its plotting accuracy.

Precautions during cleaning



- When using the cleaning liquid for maintenance, be sure to wear the goggle and gloves.



- Never disassemble the plotter. Disassembling the plotter can result in electric shock hazards and breakage of the machine.



- Prevent moisture from entering inside the plotter. If the inner part of the plotter becomes wet, electric shock hazards and breakage of the machine can result.



- Conduct maintenance works after turning off the power switch and detaching the power cable. If not, unexpected troubles can arise. Keep to the time limit, 1 hour as power-off. If the power is turned on for more than 1 hour, the nozzle-clogging preventative function does not work. In addition, if the power is turned off for more than 5 days, the ink flushing does not work either.



- Do not wipe the nozzles, wiper, or cap of the head with water or alcohol as doing so may cause nozzle clogging or damage to nozzles.



- Do not use benzene, thinner and chemical agents containing abrasives. Such materials can deteriorate or deform the surface of the cover.



- Do not apply lubricating oil or the like inside the plotter. Such materials can cause the plotter mechanism to fail.



- Be careful not to allow the cleaning liquid for maintenance or ink to adhere to the cover as this may cause deterioration or discoloring of the surface of the cover.

Cleaning fluid for maintenance

Use a cleaning fluid for maintenance corresponding to the ink used.

ES3 ink : Cleaning fluid for maintenance MS2/ES3/MS kit (SPC-0369)

SS1 ink : Cleaning fluid for maintenance RS(SPC-0336)

Maintenance for frame components

If the frame components of the plotter have become dirty, wipe off the dirt of the frame with soft cloth sopped in water or neutral detergent with water and squeezed. Wipe off dust on the table.

Cleaning Tools :

- Neutral detergent
- Soft cloth (quantity)

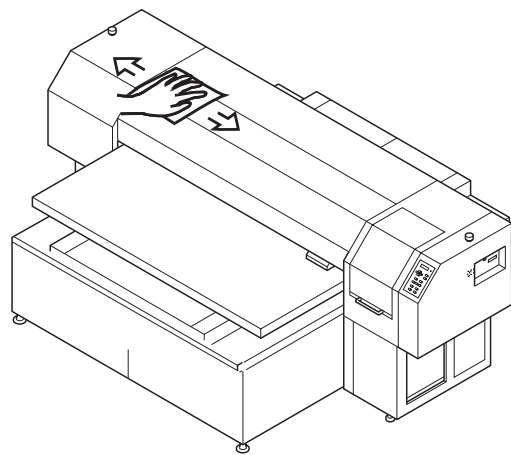

Cleaning the ink at the bottom of the slider

The ink may gel and collect under the slider after a long use. The ink droplets may grow in size and smear the work as a result. To prevent this problem, wet the supplied cotton swab in the cleaning liquid for maintenance and use it to remove the ink from under the head in regular intervals.



- **Do not use the cotton swab on the head nozzles. The cotton swab may damage the nozzles and cause poor ink delivery.**

Cleaning Tools :

- Cleaning liquid for maintenance
- Cotton swabs
- Pipette
- Goggle, Gloves

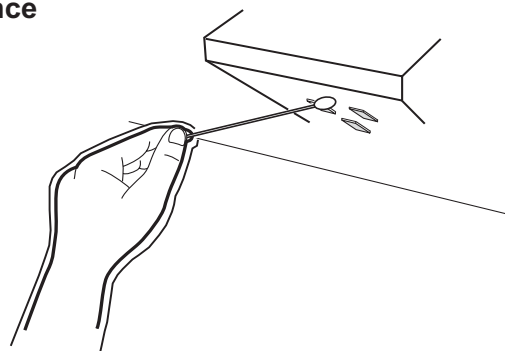







Cleaning the wiper and ink caps

The ink cap prevents clogging of the head nozzle caused by dried nozzle.

The wiper wipes out ink adhered to the head nozzle.

As the machine is used to plot images, the wipers and ink caps gradually become stained with ink and dust. Use the cotton swabs to clean the ink and wiper.

Clean the wiper and the ink cap periodically so as to keep the machine in good operation condition.

-  • **When cleaning the machine, be sure to wear the supplied goggle and gloves since you may get ink in your eyes.**
- 
-  **CAUTION**
 - **Remove dust from the wiper before starting head cleaning. A dusty wiper may damage the head and cause defective plotting.**
-  • **Clean the two wipers at a time.**
-  • **Do not move the carriage out of the capping station by hand. Use the appropriate operation key to move the carriage.**
-  • **Do not touch rubber of the new wiper as this may cause clogged nozzles.**
-  • **Once the replacement of the wiper and the cleaning of the caps have been completed, immediately press the [ENTER] key to allow the carriage to return to the capping station. If the carriage is left in the aforementioned state for an extended period of time, the nozzles can be clogged.**

Cleaning Tools :

- Cleaning liquid for maintenance
- Cotton swabs
- Goggle, Gloves

STEPS:

1. Press the [FUNCTION] key.



2. Press the XY keys [▲] or [▼] to select [MAINTENANCE].

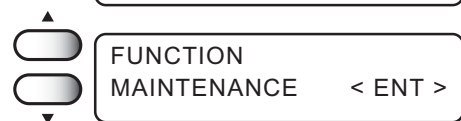

3. Press the [ENTER] key.



Cleaning the wiper and ink caps

4. Press the XY keys [▲] or [▼] to select [Station].

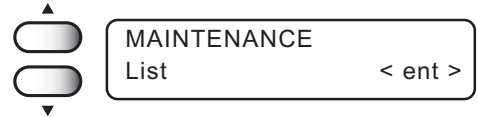

5. Press the [ENTER] key.



6. Press the [ENTER] key.

The table moves away from you and the Y-bar moves upward. The wiper moves toward you and the carriage moves away from the station.

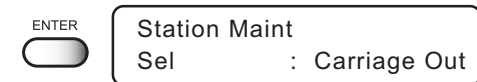

7. Open the station cover and clean the both sides of the wiper.

Remove the ink at the wiper and the bracket using a cotton swab dampened with cleaning liquid.



- If dirt or curl is serious, replace the wiper with a new one. At the time of replacement, be sure to terminate the plotter operation and follow the wiper replacement procedure. (👉 page 5.9)

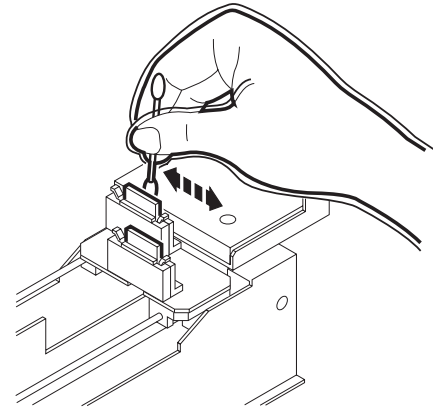

8. Clean the wiper guide shaft using a cotton swab or cloth.

If dirt is hard to remove, use a cotton swab or cloth dampened with the cleaning liquid.



- Extremely dirty wiper guide shaft may cause operational failure of the wiper, resulting in error display.

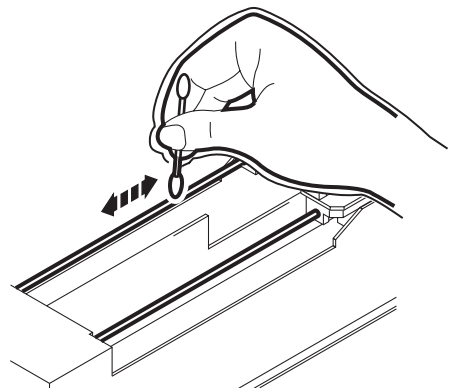

-
9. Wipe off ink or dirt adhered to the rubber of the cap using cotton swab.

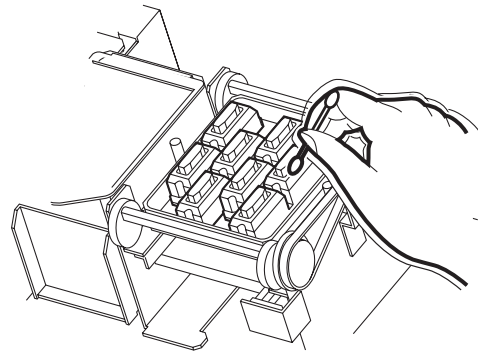

10. The station cover is closed, then press [ENTER] key.

Execute the initial operation.



Carriage Out
Completed : ent



Initialize
Please Wait



11. The machine enters the LOCAL mode.

<< LOCAL >>
X = 1010 Y = 1860

Cleaning the nozzle [Nozzle Cleaning]

Clean up the nozzle as for nozzle clogging.

If nozzle clogging cannot be resolved even after cleaning several times, execute the [Ink Filling] function. (👉 page 5.11)

If this error cannot be resolved with these functions, contact the dealer.



- **Two colors (two cartridges) per head are used. If the remaining amount of one ink is extremely greater than another ink's amount, it may flow into the cartridge which has lesser ink to make their ink-head even.**
- **Execute the [Ink Filling] function (P.5-11) if the inks are mixed.**
- **Operate it in the head only with the nozzle clogging.**

Cleaning Tools :

- Cleaning liquid for maintenance
- Cotton swabs
- Goggle, Gloves

STEPS:

1. Press the [FUNCTION] key in the LOCAL mode.



2. Press the XY [▲] or [▼] keys to select [MAINTENANCE].

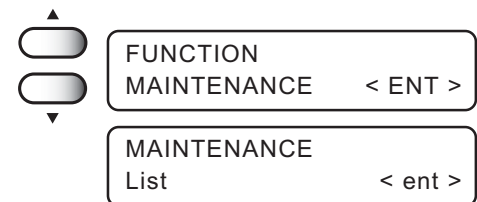

3. Press the [ENTER] key.
[Station] is displayed.

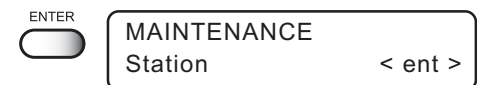

4. Press the XY [▲] or [▼] keys to select [Nozzle Clean].

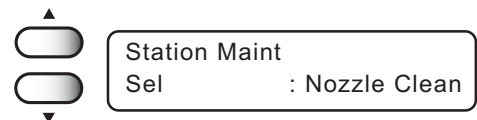

5. Press the [ENTER] key.

The table moves backward, the Y-bar moves to the top, the wiper moves forward, and the carriage moves on the table.

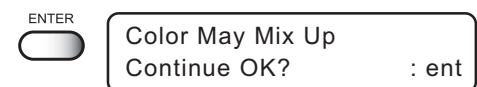

6. Open the station cover and clean the both sides of the wiper.

Remove the ink at the wiper and the bracket using a cotton swab dampened with the cleaning liquid.



- If dirt or curl is serious, replace the wiper with a new one. At the time of replacement, be sure to terminate the plotter operation and follow the wiper replacement procedure. (👉 page 5.9)

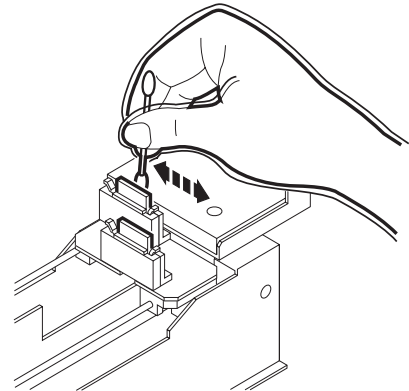

7. Clean the wiper guide shaft using a cotton swab or cloth.

If dirt is hard to remove, use a cotton swab or cloth dampened with the cleaning liquid.



- Extremely dirty wiper guide shaft may cause operational failure of the wiper, resulting in error display.

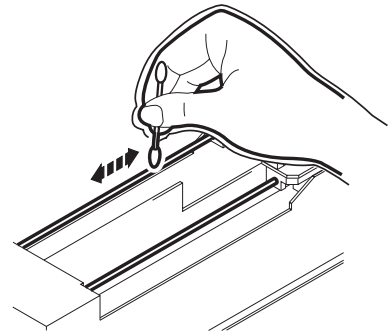

8. Clean the wiper and press the [ENTER] key.



Wiper Cleaning Completed : ent

9. Fill the cap with the cleaning liquid using a pipette.

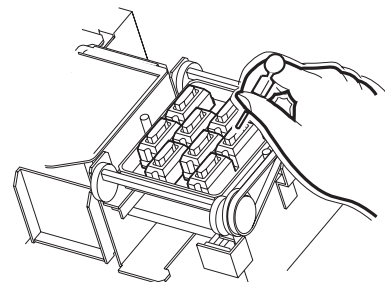

10. Close the station cover, and press the [ENTER] key.



Fill Up Washings Completed : ent

Cleaning the nozzle [Nozzle Cleaning]

11. Press the XY [▲] or [▼] keys, select the time to leave. (1-99 minutes: 1 min unit)

Normally set 1 min.



Nozzle Cleaning
Wait Timer = 1 min

12. Press the [ENTER] key.

The initial operation is performed.

Remaining time is displayed.

After remaining time is over, execute cleaning.
It displays the remaining cleaning time.

13. Cleaning is completed, the menu returns the LOCAL mode.



Initialize
Please Wait



Waiting
00 : * * : * *

Cleaning
00 : * * : * *

<< LOCAL >>
X = 1010 Y = 1860

Cleaning or replacing the mist filter

This machine is provided with two filters under the right and left of the absorption table.

When the filter is clogged, the media absorbability will be weakened.

If filter is soiled with dusts, clean it with vacuum cleaner, etc.

If the filter is clogged by ink adhesion, replace the filter.

Outfit :

- **Filter for replacing 100pcs (Order No. M-3)**
(It is the same as an ink absorber)

STEPS:

- 1. Remove the filter holder from the filter unit.**

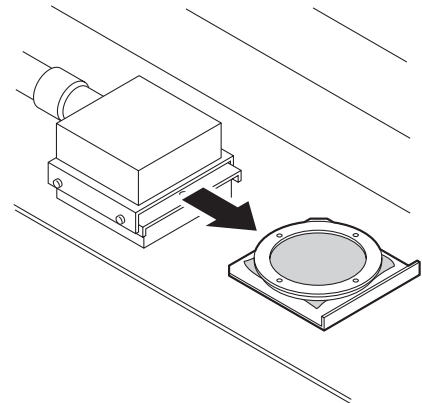

- 2. From the filter holder, remove the filter and replace with a new filter.**

Position the filter folded in four and fix it with its all circumference held.

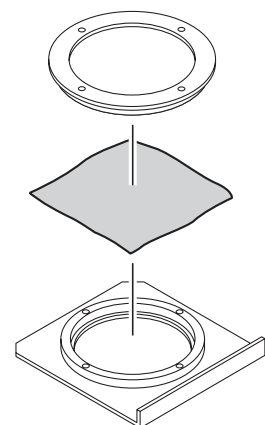

- 3. Install the filter holder on the filter unit.**

Replacing the flushing tray ink absorber

Replace the ink absorber in the flushing tray if it appears to be clogged. Clogged ink absorber may cause ink mists and smeared head nozzles.

In addition, ink bounce causes some ink drips on the nozzle during flushing. Some ink drips may cause some trouble on ink firing.

Outfit :

- Ink absorber (Order No. M-3)
(It is the same as a mist filter)

STEPS:

1. Press the [FUNCTION] key.

FUNCTION

FUNCTION
SETUP < ENT >

2. Press the XY [▲] or [▼] keys to select [MAINTENANCE].



FUNCTION
MAINTENANCE < ENT >

3. Press the [ENTER] key.

ENTER

MAINTENANCE
List < ent >

4. Press the XY [▲] or [▼] keys to select [Station].



MAINTENANCE
Station < ent >

5. Press the [ENTER] key.

ENTER

6. Press the [ENTER] key.

The table moves away from you and the Y-bar moves upward. The wiper moves toward you and the carriage moves away from the station.

ENTER

Station Maint
Sel : Carriage Out

7. Open the station cover.

8. Remove the F-cover upward from the flushing tray.

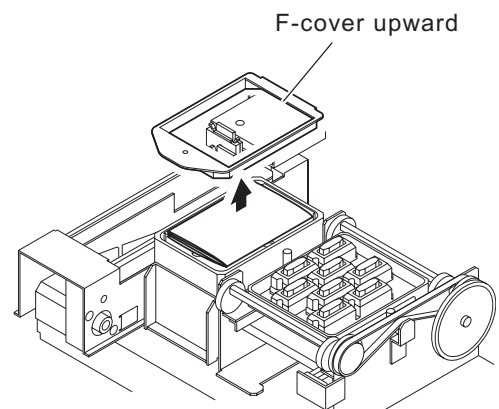

9. Remove the ink absorber.

10. Place a new ink absorber (supplied) on the tray.

Place the ink absorber (as folded) at the center.

 CAUTION

- Make certain the ink absorber is placed flat and touching the tray. Otherwise, it may interfere with the head nozzles.

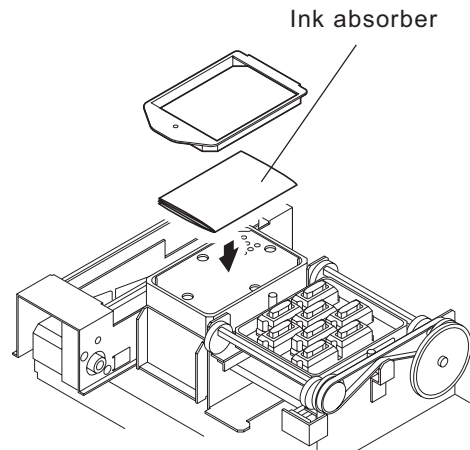

11. Place the F-cover from above.

 CAUTION

- Place the F-cover all the way down. A floating cover may cause trouble.

12. Close the station cover, then press the [ENTER] key.

The initial operation is performed.



Carriage Out
Completed : ent

Initialize
Please Wait

13. Return to the LOCAL mode.

<< LOCAL >>
X = 1010 Y = 1860

When the waste ink tank becomes full

Waste ink used for cleaning the heads will gather in the waste ink tank.

When the message “Near Full” or “Full” appears ( page.6-5), immediately replace the tank with a new waste ink tank.

Waste Ink Tank
Ink Tank Near Full

Waste Ink Tank
Ink Tank Is Full



- Contact your local MIMAKI distributor or call a local MIMAKI office if you need a spare waste ink tank.
- Prepare a polyethylene tank for emptying waste ink.



- If ink is dripping, wait until it stops dripping.
- Dispose a long-term unused waste ink regardless of its amount.

STEPS:

1. Pull out the tank toward you.



- When pulling out the waste ink tank, hold the opening of the waste ink tank with paper and then slowly pull it out to prevent waste ink from spattering.
- Before replacing ink, put paper on the floor to prevent it from being stained with ink.

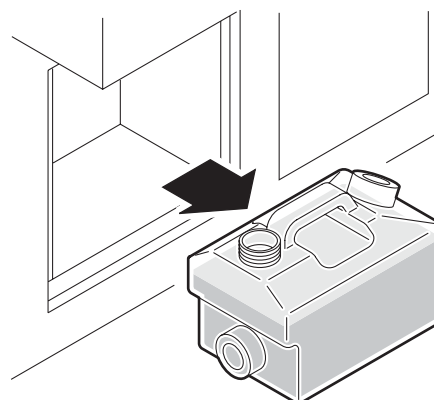

2. Dump waste ink into a separate waste oil can etc.





- Request an industrial waste processor for processing of empty cartridges.

3. Put the empty waste ink tank back in the machine.

Ink discharge way cleaning [Drain Wash]

The ink discharge way may become clogged by coagulated ink. It must be cleaned at regular intervals to avoid clogging.

Ink discharge way: Tubing between the cap and the waste ink tank

CAUTION

- When cleaning the machine, be sure to wear the goggle and gloves to prevent from getting ink in your eyes or on hands.
- Do not move the carriage out of the capping station by hand. Use the appropriate operation key to move the carriage.

Cleaning Tools :

- Cleaning liquid for maintenance
- Goggle, Gloves
- Pipette

STEPS:

1. Press the [FUNCTION] key once.



2. Press the XY [▲] or [▼] keys to select [MAINTENANCE].



3. Press the [ENTER] key.

[Station] is displayed.



4. Press the [ENTER] key.

[Carriage out] is displayed.

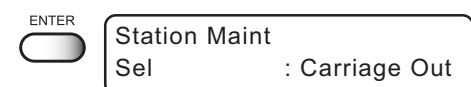

5. Press the XY [▲] or [▼] keys to select [Drain Wash].

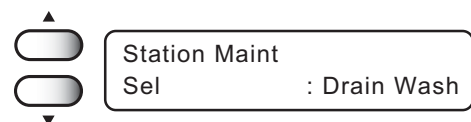

6. Press the [ENTER] key.

The table moves backward, the Y-bar moves to the top, the wiper moves forward, and the carriage moves on the table.

Dry suction starts in cycles consisting of 10 seconds of suction followed by 10 seconds of pause.

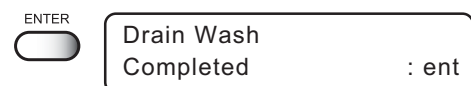

7. Open the station cover.

8. Remove the cleaning liquid with a pipette.
During the suction pause period, drop the cleaning liquid until just before it overflows from the cap.
Repeat at all other caps.

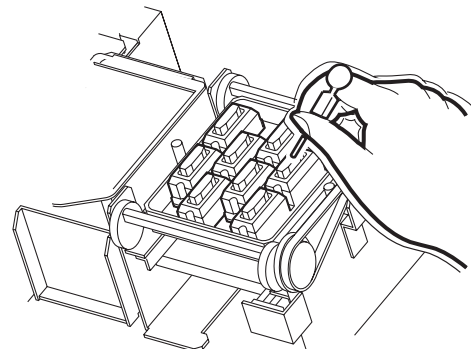

9. Close the front cover, and press the [ENTER] key.

Dry suction continues for 30 seconds and then the machine is put in LOCAL mode.



Drain Wash
Completed : ent

Initialize
Please Wait

10. Return to the LOCAL mode.

<< LOCAL >>
X = 1010 Y = 1860

When not in use the machine over the long term [Storage Wash]

When not in use the machine over a week, perform [Storage Wash] function to clean the head nozzle and ink discharge way.

After performing the function, store the machine.



- **Two colors (two cartridges) per head are used. If the remaining amount of one ink is extremely greater than another ink's amount, it may flow into the cartridge which has lesser ink to make their ink-head even.**

Execute the [Ink Filling] function (👉 page 5.11) if the inks are mixed.

Cleaning Tools :

- Cleaning liquid for maintenance
- Goggle, Gloves
- Pipette

STEPS:

1. Press the [FUNCTION] key once.



2. Press the XY [▲] or [▼] keys to select [MAINTENANCE].



3. Press the [ENTER] key.

[Station] is displayed.

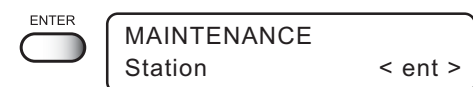

4. Press the XY [▲] or [▼] keys to select [Storage Wash].

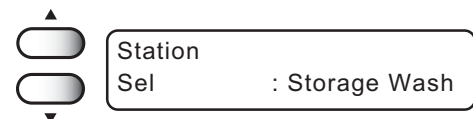

5. Attention about the ink mixing is displayed. Press the [ENTER] key.

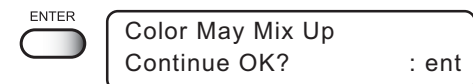

6. Press the [ENTER] key.

The table moves backward, the Y-bar moves to the top, the wiper moves forward, and the carriage moves on the table.

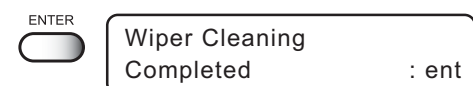

7. Open the station cover.

When not in use the machine over the long term [Storage Wash]

8. Take off the wiper with holding projections at the tips of wiper.

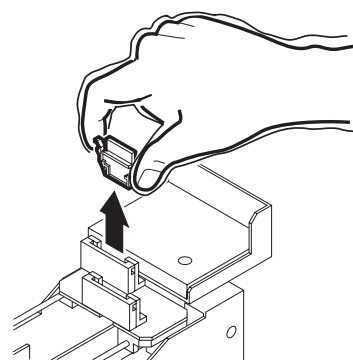

9. Use a cotton swab soaked with the cleaning liquid to clean off ink blots on wiper and bracket.

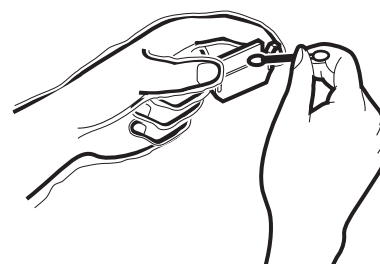

- If dirt of curl is serious, replace the wiper with a new one. At the time of replacement, be sure to terminate the machine operation and follow the wiper replacement procedure.

10. Insert the clean wiper with holding both projections at the tips of wiper.

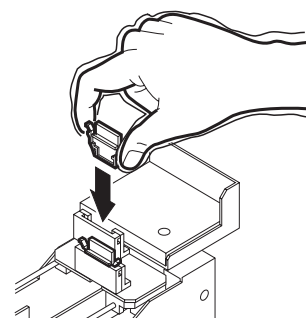

11. Press the [ENTER] key.



Wiper Cleaning Completed : ent

12. Fill the cap with the cleaning liquid using a pipette.

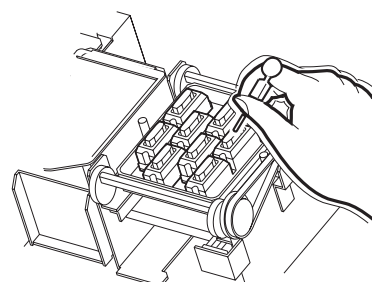

13. Close the station cover, and press the [ENTER] key.

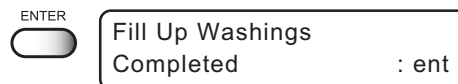

14. Press the JOG [▲] or [▼] keys, select the time to leave. (1-99 minutes: 1 min unit)

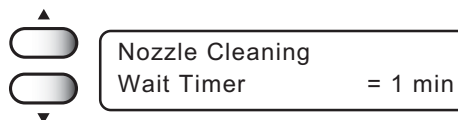

Normally set 1 min.

15. Press the [ENTER] key.

The initial operation is performed.

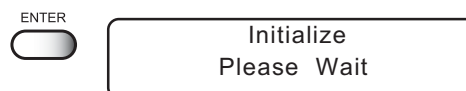

Remaining time is displayed.



After remaining time is over, execute cleaning.
Remaining cleaning time is displayed.

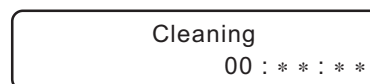

After cleaning the nozzles, the Y-bar moves to the top. The wiper moves toward you and the carriage moves away from the station.

16. Open the station cover and clean the both sides of the wiper.

17. Remove the ink at the wiper and the bracket using a cotton swab dampened with the cleaning liquid.



- If dirt of curl is serious, replace the wiper with a new one. At the time of replacement, be sure to terminate the machine operation and follow the wiper replacement procedure.

( page 5.9)

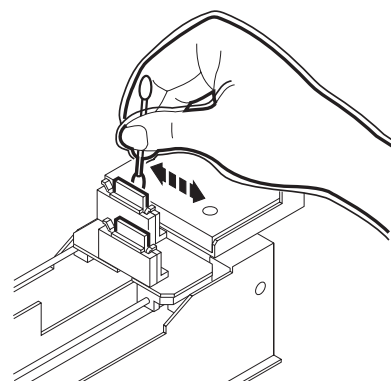

When not in use the machine over the long term [Storage Wash]

18. Clean the wiper guide shaft using a cotton swab or cloth.

If dirt is hard to remove, use a cotton swab or cloth dampened with cleaning liquid.



- Extremely dirty wiper guide shaft may cause operational failure of the wiper, resulting in error display.

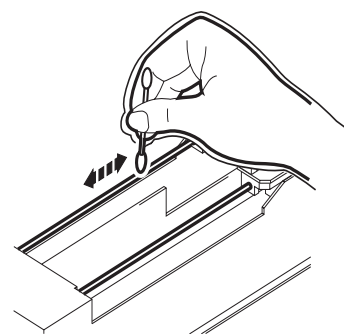

19. Clean the wiper and press the [ENTER] key.



Wiper Cleaning
Completed : ent

20. Fill the cap with the cleaning liquid using a pipette.

Dry suction starts in cycles consisting of 10 seconds of suction followed by 10 seconds of pause.

Repeat the performance of the air aspiration several times to clean up the ink discharge way.

Perform the operation for the each cap.

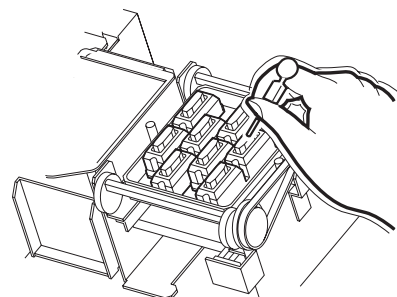

21. Close the station cover, and press the [ENTER] key.

Carriage returns the station to the initial operation performed.



Storage Wash
Completed : ent

Initialize
Please Wait



22. Return to the LOCAL mode.

<< LOCAL >>
X = 1010 Y = 1860



CHAPTER 4

How to Set Functions

This chapter describes how to set up the machine.

Table of contents

Basic operations of menus	4.2
Registering a type	4.4
Setup functions	4.5
Change the display language [DISPLAY]	4.10

Basic operations of menus

This section describes how to change over the operation modes and how to operate the menus. The following gives the key operation flow to invoke menus. For detailed menu configuration, refer to Appendix.

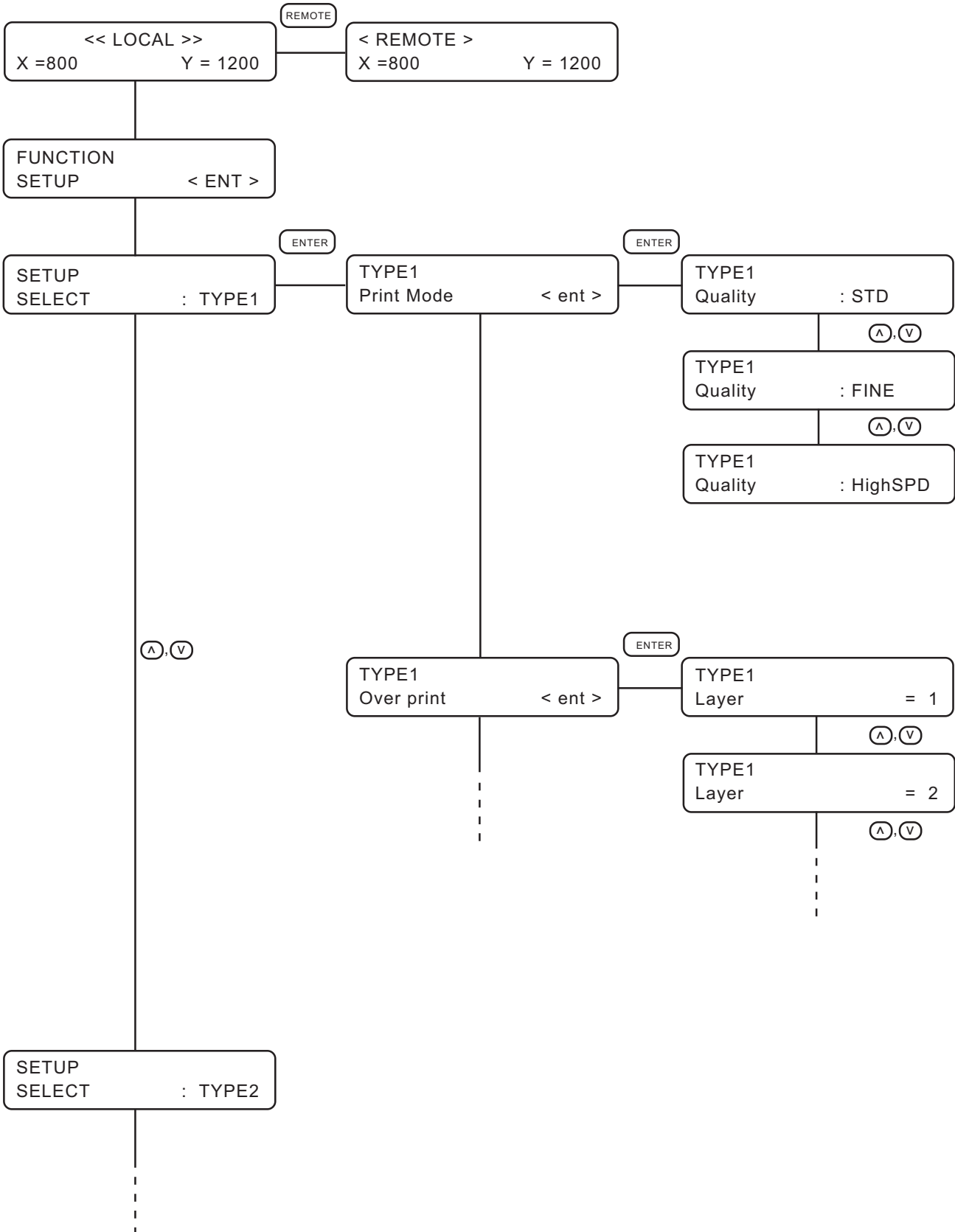

1. Select the LOCAL mode.

Ascertain first that the machine does not perform plotting under the REMOTE mode, then press the [REMOTE] key to enter the LOCAL mode.

2. Select the FUNCTION mode.

Press the [FUNCTION] key, and the machine will enter the FUNCTION mode.

The FUNCTION mode is divided into two: the setup function and maintenance function. Select either function.

3. Select a type.

There are four types. The FUNCTION mode can be set for each type depending on the media type used.

4. Select the Function.

Select the function pressing the XY [▲] or [▼] keys.

5. Enter the Function selected.

Press the [ENTER] key.

6. Select a parameter.

Press the XY [▲] or [▼] keys to select a parameter.

7. Enter the specified value.

Press the [ENTER] key.

8. Restore the LOCAL mode.

Press the [END] key several time to restore the LOCAL mode.

Registering a type

The FUNCTION mode enable to registers 4 types.

If the type has been registered for each medium type, it becomes easy to change plotting conditions when the medium type is changed.

Example) Type1 : ABS
Type2 : PS
Type3 : PCV
Type4 : check

STEPS:

1. Make sure that the mode is LOCAL mode.



<< LOCAL >>
X =1010 Y = 1860

2. Press the [FUNCTION] key.



FUNCTION
FUNCTION
SETUP < ENT >

3. Press the [ENTER] key.

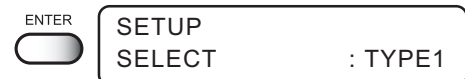

ENTER
SETUP
SELECT : TYPE1

4. Press the XY [▲] or [▼] keys to select any of types 1 through 4.



▲
▼
SETUP
SELECT : TYPE1

5. Press the [ENTER] key.

Setting Plotting Conditions.

(☞ page 4.5 through 4.7)

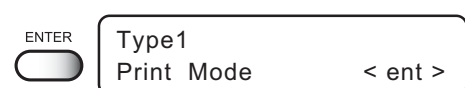

ENTER
Type1
Print Mode < ent >

Changing the type

If plotting conditions for types 1 through 4 have already been registered, settings can be selected according to the plotting simply by selecting the type.

1. Perform steps 1 through 5 above.

Select a type.

2. Press the [END] key.

Plotting with the plotting condition registered for the selected type is possible.

Setup functions

The FUNCTION mode consists of 14 items.

The following describes the overview of and settings for each function.

Print Mode

Sets the plot quality, plot direction.

Quality : Select the quality image from three items.

[STD] : Standard image quality

[FINE] : High image quality and low plotting speed

[High SPD] : High plotting speed and slightly inferior image quality

DIRECTION: Specifies the head movement direction along which plotting is made.

[UNI-D] : Specifies that plotting is made while the head is moving to the left.

[BI-D] : Specifies that plotting is made while the head is moving to the left and right.

This mode allows higher plotting speed with a lower plot quality than UNI-D.

Return SPD: The unidirectional plot within 1000mm width may cause nozzle drop-out. Nozzle drop-out can be solved by head's return at low speed.

[NORMAL] : The head returns at normal speed.

[SLOW] : Make the head return at low speed.

LOGICALseek: Normally, the head moves all the way to both ends of the media to make plotting.

With LOGICAL seek, the head moves to the left and right according to the width of the plot image to make plotting.

This can reduce the plotting time.

The head movements are shown below.

OFF (UNI-DIRECTIONAL) OFF (BI-DIRECTIONAL)

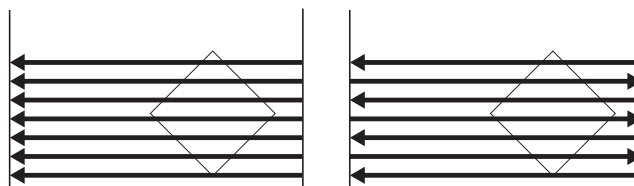

ON (UNI-DIRECTIONAL)

ON (BI-DIRECTIONAL)

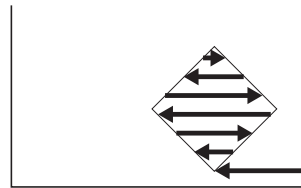
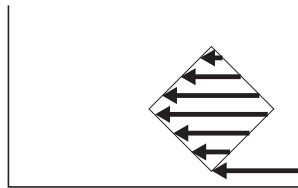

Overprint

Sets the number of overprinting if ink coloring is poor.

The number of Overprinting : 1 – 9



For nonflammable cloth and silk, do not perform overprinting.

Overprinting will cause the media to expand/contact by ink moisture producing wavy finished surface.

DRYING TIME

It sets the function for drying ink.

The drying time is the wait time by scanning.

Specify the time to be established in accordance with the plotting resolution on a plotting and the type of work to be used.

Time : 0.0 – 9.9 sec

Sets the time of temporary stop by scanning of the head.

Priority

Specifies whether the values set on the machine (plot) are given priority or the values set on the computer (host) are enabled as for the following five functions.

- Print Mode
- Overprint
- Drying Time
- Feed Correct
- Refresh

[HOST] : The plotting operation is performed with priority given to the plotting conditions set on the computer.

[PLOT] : The plotting operation is performed with priority given to the plotting conditions set on the machine.

Refresh

Solidification of ink can be prevented by refreshing the head during plotting.

If this function is executed in a dusty place or dry place, ink in the head will be likely to solidify.

A larger level results in more number of refreshes.

Number of refreshes : Level 0 – 3

mm/ inch

Set a unit of set values displayed.

When the machine is shipped from the factory, the unit of display is set to “mm” (millimeter).

[mm] : Numerics are expressed in millimeters.

[inch] : Numerics are expressed in inches.

Feed Correct (👉 page 2.15)

When the machine is not plot a clear image (e.g., unwanted stripes may appear on the image), to correct the work feed rate.

[Offset] : -100 – 100

Auto Clean

The head is cleaned automatically. Perform cleaning for each print to prevent plotting failures.

[ON] : The head is cleaned automatically.

[OFF] : The head is not cleaned automatically.

Color pattern

Plot a color pattern at the right end of the media. Nozzle clogging can be checked during plotting. When setting the [COLOR PATTERN] to ON, the plot starting position of the image moves 18 mm to the scan direction from the origin.

The plot-able width becomes smaller. Therefore, when plotting is made all the way to both ends of the media, turn this function off.

- [ON] : The color pattern is plotted.
- [OFF] : The color pattern is not plotted.

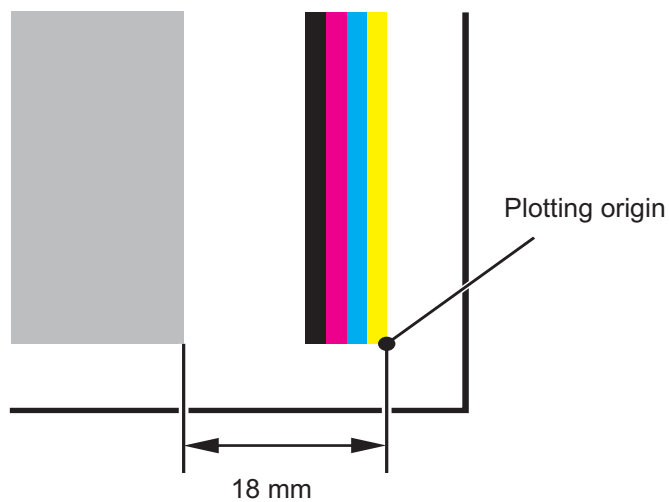

Setup Reset

This function resets the current plotting conditions to the factory-set plotting conditions.

Execute this function for each of the types of set plotting conditions.

- [ENTER] : All setup is reset.
- [END] : End without reset.

Change the display language [DISPLAY]

Display language enable to change Japanese or English. This procedure explains how to change Display language to ENGLISH.

STEPS:

1. Make sure that the mode is LOCAL mode.



<< LOCAL >>
X =1010 Y = 1860

2. Press the [FUNCTION] key.



FUNCTION
FUNCTION
SETUP < ENT >

3. Press the XY [▼] key twice.



FUNCTION
DISPLAY < ENT >

4. Press the [ENTER] key.



ENTER
DISPLAY
JAPANESE < ent >

5. Press the XY [▲] or [▼] keys to select the language.



DISPLAY
ENGLISH < ent >

6. Press the [ENTER] key.

The machine enters the LOCAL mode.



<< LOCAL >>
X =1010 Y = 1860

CHAPTER 5

Maintenance

In order to keep the machine in good operating condition, it is necessary to carry out maintenance of the machine periodically.

This chapter introduces special features for correcting poor plotting quality and replacing the wipers.

Table of contents

Maintenance of the machine	5.2
Plotting setup conditions [LIST]	5.4
Plotting HEX CODE [DATA DUMP]	5.5
When medium thickness is changed [Print Adjust]	5.6
Cleaning the station interior [Station]-[Carriage Out]	5.8
When the message [Replace Wiper] is displayed	
[Station]-[Wiper Exchng]	5.9
Fill up the ink [Ink Filling]	5.11
Wiper Life warning [Wiper Level]	5.12
Displaying the firmware version [INFORMATION]	5.13
Specifying the plot head line [Use Head]	5.14
Execute the flushing and cleaning regularly [Routine Control]	5.15

Maintenance of the machine

The term “maintenance” as used herein refers to actions that need to be taken to keep the machine in good operating condition.

To carry out maintenance of the machine, select [MAINTENANCE] from the function menu and make the necessary settings.

Setting the maintenance function

In order to execute any of the maintenance functions, it is necessary to perform the following operation on the operation panel.

You have to understand how to invoke the desired maintenance function to carry out maintenance.

STEPS:

1. Make sure that the mode is LOCAL mode.



<< LOCAL >>
X = 1010 Y = 1860

2. Press the [FUNCTION] key.



FUNCTION
SETUP < ENT >

3. Press the [▲] or [▼] keys to select [MAINTENANCE].



FUNCTION
MAINTENANCE < ENT >

4. Press the [ENTER] key.



ENTER
MAINTENANCE
List < ent >

5. Select the next operation.

Set up the desired maintenance function to carry out maintenance. (☞ page 5.3)

Maintenance setup functions

The following describes the overview of and settings for each function.

Name	function	
List	Plotting the set condition of the machine.	page 5.4
Data Dump	Plotting data commands received from the computer, in HEX code.	page 5.5
Print Adjust	Adjust the dot position according to the head height, high/low.	page 5.6
Station	Clean the inside of the station and replace the wiper. (Wiper Exchng, Carriage Out, Nozzle Clean)	page 5.8
Ink Filling	Fill up the ink. Perform it when nozzle clogging is still not solved. In addition, when Nozzle cleaning or Storage Wash is performed, this may cause color mixture. Perform it when ejecting mixed color ink.	page 5.11
Ink Change	This is not normally used.	-
Information	Display the firmware versions of this machines and an interface.	page 5.13
Routine Ctrl	To set Routine Flushing or Routine Cleaning on/off and interval.	page 5.15
Wiper Level	Select the level of changing the wiper.	page 5.12
Head To Use	When making plotting, using only headline which set this function.	page 5.14

Plotting setup conditions [LIST]

This function lists the current settings of the machine.

This is useful in carrying out maintenance of the machine.

1. **SET UP** : Indicates a value that is specified with the FUNCTION.
2. **PRINT adjust** : Indicates a correction value for dot position.
3. **REPLACE COUNTER** : Indicates the number of times the ink cartridges are replaced.
4. **VERSION** : Indicates the version of the firmware and memory capacity of the machine.
5. **PARAMETER** : To be used by customer engineer for maintenance.



- **When the [LIST] function is used to plot data commands on paper, use 297mm x 210mm or larger size with the long side set horizontally.**

```

LIST (System Ver1.00) ([/F Ver1.40) S/N : 00000000
(1) SET UP TYPE1 < TYPE2 > TYPE3 TYPE4
MEDIA COMP. 0 :HOST 100 :HOST 0 :HOST 0 :HOST
HEATER PRE OFF :HOST 200 :HOST OFF :HOST OFF :HOST
PRINT OFF :HOST 20 :HOST OFF :HOST OFF :HOST
C/F °C °C °C °C
STANDBY 0min 10min 0min 0min
OFF 0min 30min 0min 0min
PRINT MODE STD :PLOT FAST :PLOT STD :HOST STD :HOST
DIRECTION UNI-D UNI-D UNI-D :HOST UNI-D :HOST
LOGICALseek ON ON ON ON
INK LAYERS 1 :HOST 1 :HOST 1 :HOST 1 :HOST
DRYING TIME 0.0s 0s :HOST 0.0s 0s :HOST 0.0s 0s :HOST 0.0s 0s :HOST
AUTO CUT OFF :HOST OFF :HOST OFF :HOST OFF :HOST OFF :HOST
MARGIN RIG 0mm 0mm 0mm 0mm
LEFT 0mm 0mm 0mm 0mm
COLOR PTN. OFF ON OFF OFF
REFRESH LEVEL3 :HOST LEVEL3 :HOST LEVEL3 :HOST LEVEL3 :HOST
MEDIA SET SELECT SELECT SELECT SELECT
VACUUM STANDARD STANDARD STANDARD STANDARD
MM/INCH MM MM MM MM
STAMP MODE OFF ON OFF OFF
TIME OFF ON OFF OFF
AUTO CLEAN OFF OFF OFF OFF
(2) WIPE LEVEL 1/1
(3) deodorizFAN OFF
(4) DISPLAY English
(5) PRINTadjust PATTERN1 PATTERN2 PATTERN3 PATTERN4
0.0 0.0 0.0 0.0
PATTERN5 PATTERN6 PATTERN7
0.0 0.0 0.0
(6) REPLACE CNT
CARTRIDGE 1: 87 2: 53 3: 42 4: 65 5: 58 6: 29
REMAIN 1: 65% 2: 67% 3: 83% 4: 100% 5: 65% 6: 65%
SHOT COUN 1: 1896 2: 1276 3: 1430
4: 1355 5: 1913 6: 1810
SCAN COUNT 1 (x1000)
DRAW AREA 5m² 53sq.ft.
USE TIME 31h
SLEEP REF. 0 0h9m
Date : 02.10.04 23:43

```

When medium thickness is changed [Print Adjust]

When the head height is adjusted, be sure to correct the dot positions.

This function corrects the dot positions to ensure that the accurate plotting result is obtained.

The dot positions are corrected by comparing the ink dropping positions on each of the seven test patterns between the two plotting directions.

Always perform Print Adjust (dot position correction) whenever the head height is changed.

STEPS:

1. Set a sheet of paper, use 297mm x 210mm or larger size with the long side set horizontally, and set the Origin.

2. Select the [Print Adjust].



3. Press the [ENTER] key.

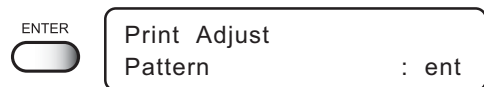

4. Press the [ENTER] key.

Plotting of the test patterns for the correction of dot position starts. There are seven types of test patterns that are plotted.

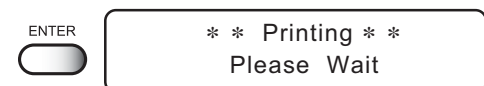



5. Press the XY [▲] or [▼] keys to correct the dot position of pattern 1.

The seven test patterns that are output are sequentially named [PATTERN 1] to [PATTERN 7].

Select the correct dot positions on [PATTERN 1] pressing the XY [▲] or [▼] keys.

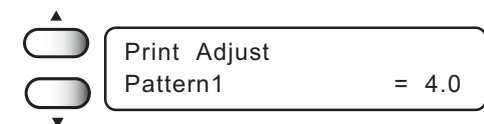
Select the dot positions that make a straight line on the test pattern in the two plotting directions.





• If the pattern correction value for straight lines is not within -15 through +15, adjust the head height and then correct it again with [Print Adjust].

Select the dot positions 4.0 that make a straight line on the test pattern in two plotting direction.

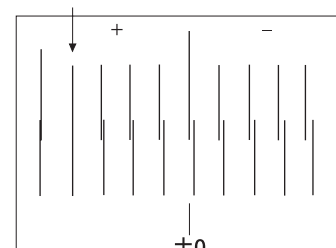

When medium thickness is changed [Print Adjust]

6. Press the [ENTER] key.



Print Adjust
Pattern2 = 0.0

7. Repeat STEPS 5 and 6 to correct the dot positions on Patterns 2 to 7.

Select the correct dot positions on each of the patterns.

Print Adjust
Pattern3 = 0.0

Print Adjust
Pattern4 = 0.0

Print Adjust
Pattern5 = 0.0

Print Adjust
Pattern6 = 0.0

Print Adjust
Pattern7 = 0.0

Enter the dot position correction value on Patterns 1 to 7 and then terminate dot position correction.

Print Adjust
Pattern : ent

8. Press the [END] key to complete [Print Adjust].



MAINTENANCE
Print Adjust < ent >

9. Press the [END] key twice, and the menu returns to the LOCAL mode.



<< LOCAL >>
X =1010 Y = 1860

Cleaning the station interior [Station]-[Carriage Out]

There are the following items regarding [Station Maint].

- Carriage Out : Move the carriage for maintenance of the station interior. (👉) page 3.4
- Wiper Exchnng : When the message [Wiper Exchnng] is displayed, replace the wiper. (👉) page 3.4
- Nozzle Clean : Clean the nozzle using the cleaning kit. (👉) page 3.7

The following section describes how to move the carriage.

- Do not move the carriage out of the capping station by hand.
- Use the XY key to move the carriage.

STEPS:

1. Press the [▲] or [▼] keys to select [Station].



2. Press the [ENTER] key.

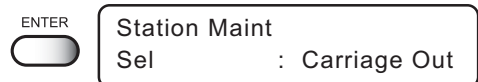

3. Press the [ENTER] key.

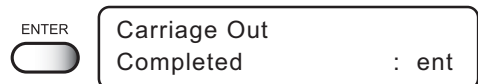

4. Open the station cover, then perform the following maintenance works for the station interior.

1. Cleaning the ink caps. (👉) page 3.4
2. Cleaning the wiper. (👉) page 3.4
3. Cleaning the ink at the bottom of the slider. (👉) page 3.3
4. Replacing the flushing tray ink absorber. (👉) page 3.11
5. Replacing the wiper. (👉) page 5.9

When the message [Replace Wiper] is displayed on the LCD, replace the wiper.

5. Close the station cover, then press the [ENTER] key.

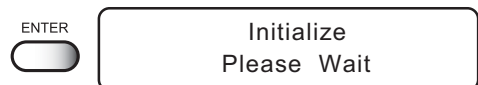

6. The machine enters the LOCAL mode.



When the message [Replace Wiper] is displayed [Station]- [Wiper Exchng]

The wipers are consumable parts. When the following message is displayed, replace the wipers with new ones.

Wiper
Replace Wiper



CAUTION

- Do not select [Wiper Exchng] unless the wiper is to be really changed. The number of wiper operations that is counted in the machine will be reset.



- The cleaning wiper is sold separately. For details, refer your dealer.

STEPS:

1. Press the [▲] or [▼] keys to select [Station].



2. Press the [ENTER] key.

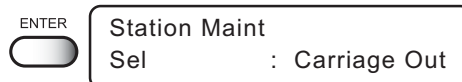

3. Press the [▲] or [▼] keys to select [Wiper Exchng].

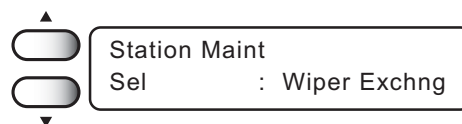

4. Press the [ENTER] key.

The wiper moves toward you and the carriage moves away from the station.



5. Open the station cover.

6. Take off the wiper with holding projections at the tips of wiper.

Use the gloves that are supplied with the separately-available clean wiper to protect your hands from stains.

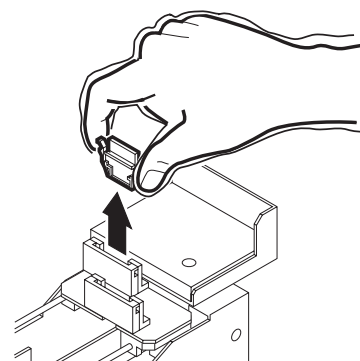

7. Insert a new wiper with holding both projections at the tips of wiper.

 CAUTION

- Contacting the rubber portion of a new wiper shall be avoided. It can cause the nozzle to be clogged.
- Insert the wiper so that its felt side surface is placed on the left as viewed from your position.

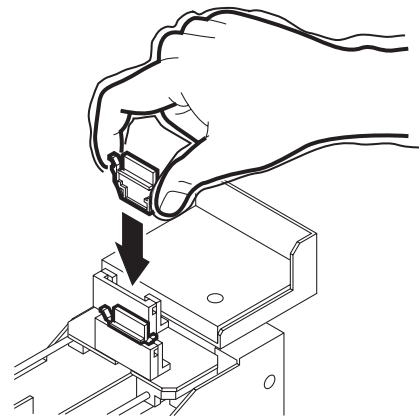

8. Clean the wiper guide shaft using a cotton swab or cloth.

If dirt is hard to remove, use a cotton swab or cloth dampened with cleaning liquid.

 CAUTION

- Cleaning the wiper guide shaft. ( page 3.4) Extremely dirty wiper guide shaft may cause operation failure of the wiper, resulting in error display.

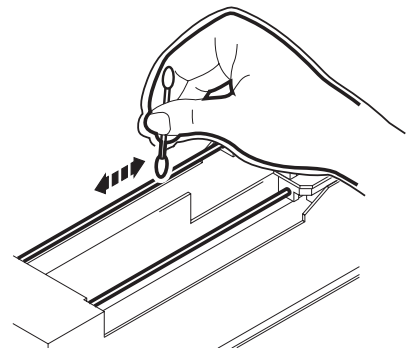

9. Check the flushing tray ink absorber. Replace if ink is found on the ink absorber.

( page 3.11)

10. Close the station cover, then press the [ENTER] key.

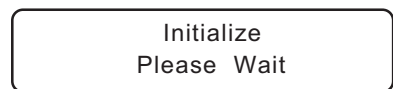

11. The machine enters the LOCAL mode.



Fill up the ink [Ink Filling]

Perform the [Storage Wash] function for nozzle clogging when head cleaning or [Nozzle cleaning] does not work.

In addition, when the [Nozzle cleaning] function or the [Storage Wash] function is performed, this may cause color mixture.

Perform the [Ink Filling] function to discharge mixed color ink.

STEPS:

1. Make sure that the **FUNCTION** mode is displayed.



2. Press the [▲] or [▼] keys to select [MAINTENANCE].



3. Press the [ENTER] key.

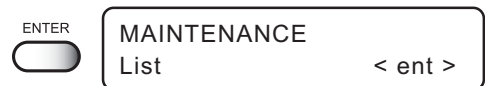

4. Press the [▲] or [▼] keys to select [Ink Filling].

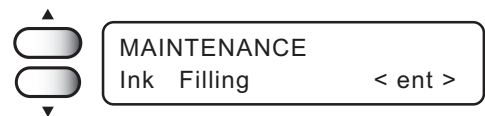

5. Press the [ENTER] key.

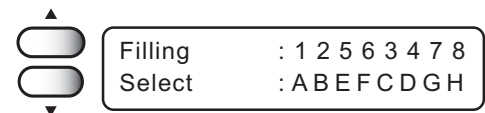

6. Press the XY [◀] or [▶] keys to select a head with no ink.

1256/3478/ABEF/CDGH



7. Press the XY [▲] or [▼] keys to indicate a head with no ink by [----].

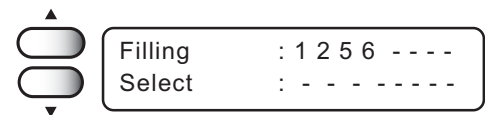

8. Press the [ENTER] key.

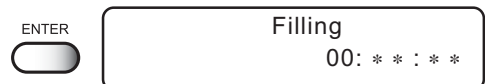

9. When filling up some ink, back to STEP 4.

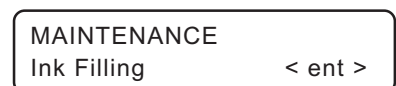

Wiper Life warning [Wiper Level]

The wipers are consumable parts. The head become dirty easily on dusty locations.
The head cannot be cleaned adequately with a curled or worn wiper.
This setting move up the wiper replacement warning depending on the operating environment.

STEPS:

1. Press the XY [▲] or [▼] keys to select [Wiper level].



2. Press the [ENTER] key.



3. Press the XY [▲] or [▼] keys to select the displaying level for changing a wiper.

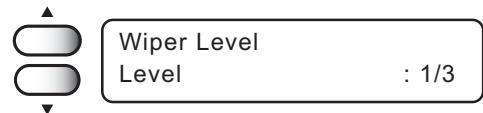

- 1/1 : Several times of the standard wiping displays the warning for changing a wiper.
(Initial value)
- 1/2 : A half time of the standard wiping displays the warning for changing a wiper.
- 1/3 : A third time of the standard wiping displays the warning for changing a wiper.
- 1/4 : A quarter time of the standard wiping displays the warning for changing a wiper.

4. Press the [ENTER] key.
5. Press the [END] key twice, and the menu returns to the LOCAL mode.

Displaying the firmware version [INFORMATION]

Display the firmware versions of this machines and an interface.

If trouble occurs, please inform the dealer or MIMAKI sales office of the contents of the trouble as well as this information.

STEPS:

1. Make sure that the **FUNCTION** mode is displayed.



2. Press the **[▲]** or **[▼]** keys to select the **[MAINTENANCE]**.



3. Press the **[ENTER]** key.

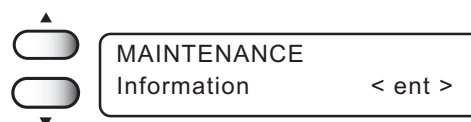

4. Press the **[▲]** or **[▼]** keys to select the **[Information]**.

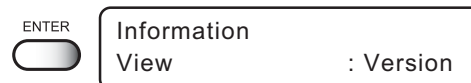

5. Press the **[ENTER]** key.



6. Select **[Version]**, then press the **[ENTER]** key.

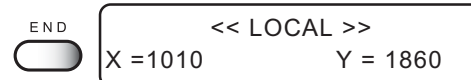

7. Press the **[END]** key for times, and the menu returns to the **LOCAL** mode.

Specifying the plot head line [Use Head]

Use this function if nozzle missing cannot be recovered even after repetitive cleaning or if plotting with higher quality is required. Divide the 16 (4x4) nozzles in the carriage into four horizontal rows to specify the plot headline.

STEPS:

1. Press the [▲] or [▼] keys to select [Use Head].

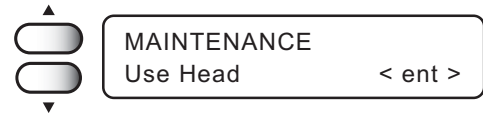

2. Press the [ENTER] key.

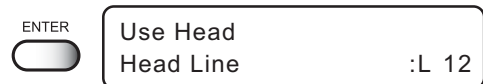

3. Press the XY [▲] or [▼] keys to select the use head.

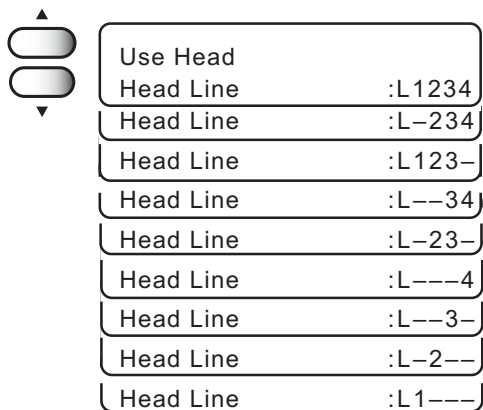
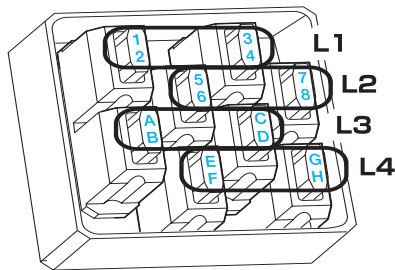

4. Press the [ENTER] key.

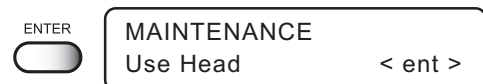

5. Press the [END] key twice, and the menu returns to the LOCAL mode.

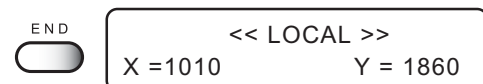

Execute the flushing and cleaning regularly [Routine Control]







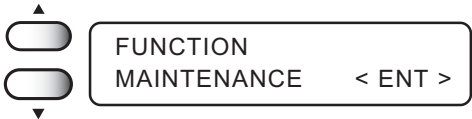

Set time limits on the flushing and cleaning functions at regular time intervals to avoid nozzle clogging and clean off dust on the nozzle surface.

Routine Flushing

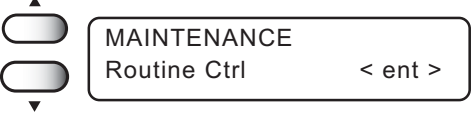
The routine flushing function is executed with the power on.

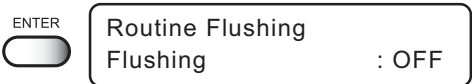
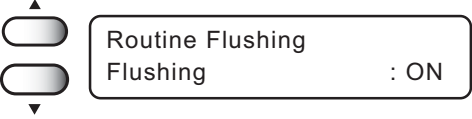
Time set by the hour is available for 1 to 24 hrs with this function turns on.

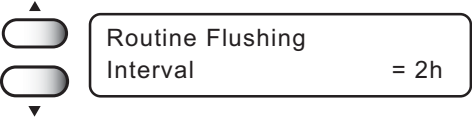
STEPS:















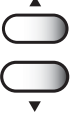

- 1. Make sure that the FUNCTION mode is displayed.**
The screen shows 'FUNCTION' at the top left, 'FUNCTION SETUP' in the center, and '< ENT >' at the bottom right. A 'FUNCTION' button is shown to the left of the screen.
- 2. Press the [▲] or [▼] keys to select [MAINTENANCE].**
The screen shows 'FUNCTION MAINTENANCE' in the center and '< ENT >' at the bottom right. Up and down arrow buttons are shown to the left of the screen.
- 3. Press the [ENTER] key.**
The screen shows 'MAINTENANCE Station' in the center and '< ent >' at the bottom right. An 'ENTER' button is shown to the left of the screen.
- 4. Press the [▲] or [▼] keys to select [Routine Ctrl].**
The screen shows 'MAINTENANCE Routine Ctrl' in the center and '< ent >' at the bottom right. Up and down arrow buttons are shown to the left of the screen.
- 5. Press the [ENTER] key.**
The screen shows 'Routine Control Select : Flushing' in the center. An 'ENTER' button is shown to the left of the screen.
- 6. Select [Routine Flushing], then press the [ENTER] key.**
The screen shows 'Routine Flushing Flushing : OFF' in the center. An 'ENTER' button is shown to the left of the screen.
- 7. Press the [▲] or [▼] keys to select [ON].**
The screen shows 'Routine Flushing Flushing : ON' in the center. Up and down arrow buttons are shown to the left of the screen.
- 8. Press the [ENTER] key.**
The screen shows 'Routine Flushing Interval = 1h' in the center. An 'ENTER' button is shown to the left of the screen.
- 9. Press the [▲] or [▼] keys, and select time interval.**
The screen shows 'Routine Flushing Interval = 2h' in the center. Up and down arrow buttons are shown to the left of the screen.
- 10. Press the [ENTER] key.**
The screen shows 'MAINTENANCE Routine Ctrl' in the center and '< ent >' at the bottom right. An 'ENTER' button is shown to the left of the screen.

Routine Cleaning

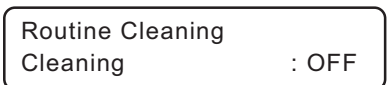
The routine cleaning function is executed with the power on.

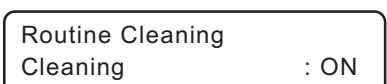
Time set by the hour is available for 1 to 48 hrs with this function turns on.

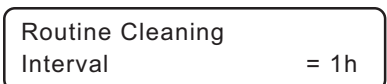
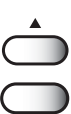
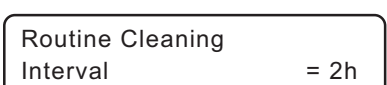
STEPS:

- 1. Make sure that the FUNCTION mode is displayed.**
 
- 2. Press the [▲] or [▼] keys to select [MAINTENANCE].**
 
- 3. Press the [ENTER] key.**
 
- 4. Press the [▲] or [▼] keys to select [Routine Ctrl].**
 
- 5. Press the [ENTER] key.**
 
- 6. Select [Routine Cleaning], then press the [ENTER] key.**
 
- 7. Press the [▲] or [▼] keys to select [ON].**
 
- 8. Press the [ENTER] key.**
 
- 9. Press the [▲] or [▼] keys, and select time interval.**
 
- 10. Press the [ENTER] key.**
 

CHAPTER 6

When Abnormal Conditions Are Encountered

Chapter 6 describes corrective measures to be taken in the case where an to be taken in case an abnormal condition arises and an error message appears on the display.

Table of contents

Abnormal conditions where no error message appears	6.2
If image quality declines	6.3
Problems where error messages are given on the LCD	6.4

Abnormal conditions where no error message appears

Corrective measures for problems where no error message is given on the LCD are described in this section. Be sure to take the following measures before contacting MIMAKI. If the measures fail to fix the machine, contact your local MIMAKI distributor or MIMAKI office for service.

The machine cannot be energized

More often than not, this is due to improper connection of the power cable. Check that the power cable has been properly connected to the power outlet and the computer.

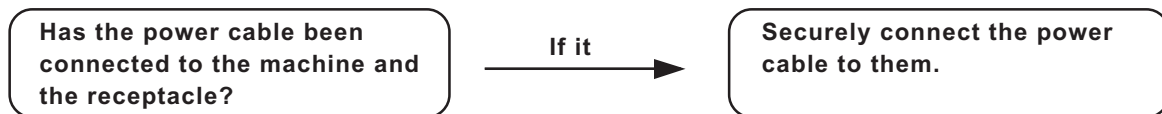

The machine cannot perform plotting

This occurs when the data is not being transmitted to the machine properly. It can also occur when any of the machine functions fails or the medium has been set improperly.

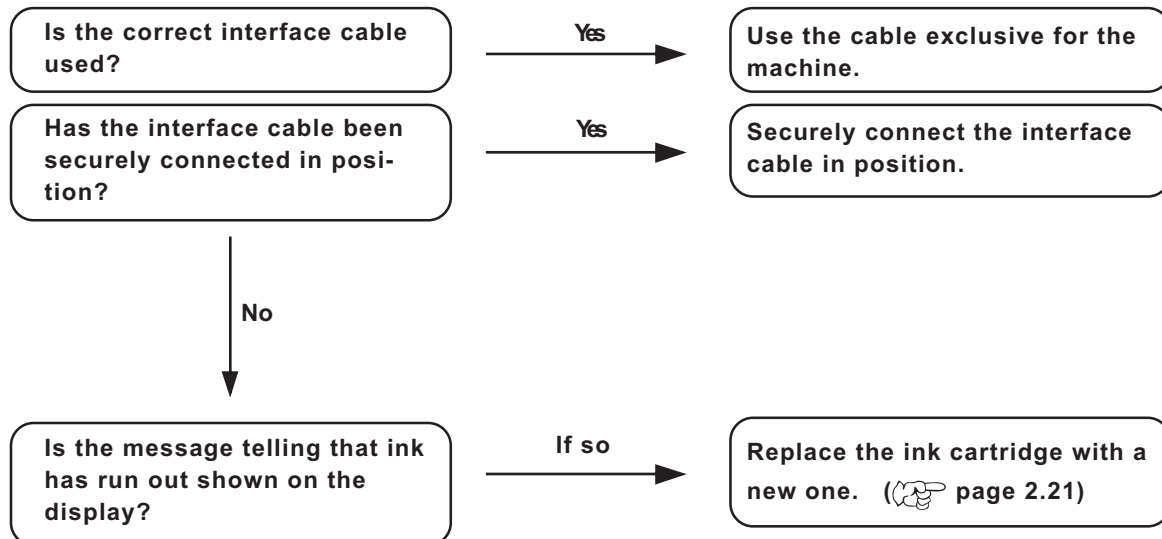

If image quality declines

Corrective measures against problems where satisfactory image quality is not provided are described in this station. Take measures in accordance with actual state of the picture.

If the measures fail fix the machine, contact your local MIMAKI distributor or MIMAKI office call for service.

While lines/thin spots are obvious or dark stripes occur (In the direction of travel of the head)

- Corrective measure : Clean the head. (☞ page 2.12)
- Corrective measure : Clean the interior of the station.
(☞ page 3.4, 5.8)
- Corrective measure : Conduct the [Feed Correct] function. (☞ page 2.15)
- Corrective measure : If slip of paper is present in the head path, for example, above the work plate, remove it.

Characters fluctuate doubly or triply into paper feed

- Corrective measure : Conduct the [Feed Correct] function. (☞ page 2.15)

Displacement is observed between outward and inward plotting

/The respective color ink injected by the respective color heads do not properly overlap

- Corrective measure : Conduct the [Print Adjust] function.
(☞ page 5.6)

Large ink drop on medium

- Corrective measure :
1. Clean the wiper. (☞ page 3.4)
 2. Clean the ink caps. (☞ page 3.4)
 3. Clean the bottom of the slider. (☞ page 3.3)
 4. Execute the head cleaning [normal]. (☞ page 2.13)
 5. If ink drop occurs again over time, perform Head cleaning [Hard]. (☞ page 2.13)
 6. Dust the work.
 7. Dust the table.

Become lighter during the printing and then plotting without ink

- Corrective measure : Reduce the printing density by resetting the RIP setting or remaking the data.

Some strip streaks occur on the image with narrow plot width

- Corrective measure : Set the head return speed, SLOW. (☞ page 4.5)

Problems where error messages are given on the LCD

If something is wrong with the machine, the buzzer sounds and a corresponding error message is given on the LCD.



Take an appropriate corrective measure in accordance with the message.

Errors accompanied by warnings

These errors arise on the ink-related components.

Warning message	Cause	Corrective measure
Ink Cartridge 1 2 3 4 5 6 7 8 A B C D E F G H	Ink cartridge is not loaded on the ink station.	Attach the ink cartridge(s) corresponding with the number(s) shown on the display.
Ink Near End 1 2 3 4 5 6 7 8 A B C D E F G H	The amount of ink remaining in the ink cartridge is insufficient.	Printing can continue by pressing the [REMOTE] key. However, it is recommended that you replace the ink cartridge is shown on the LCD with a new one.
Ink End 1 2 3 4 5 6 7 8 A B C D E F G H	The ink cartridge has run out of ink.	Replace the ink cartridge shown on the LCD with a new one.
Ink Limit 1 2 3 4 5 6 7 8 A B C D E F G H	The ink cartridge will expire soon or has expired.	
Ink Low 1 2 3 4 5 6 7 8 A B C D E F G H	Not enough ink for cleaning.	Replace the ink cartridge of the displayed number before cleaning.
Ink Color 1 2 3 4 5 6 7 8 A B C D E F G H	The color of the loaded ink cartridge is different from the previous one.	Check the number of the loaded ink cartridge.
Ink Type 1 2 3 4 5 6 7 8 A B C D E F G H	The type of the loaded ink cartridge is different from the previous one.	
Unidentified Ink 1 2 3 4 5 6 7 8 A B C D E F G H	Ink that being used is not real.	Use the MIMAKI general ink.
Head Unidentified ID	Head ID not been registered.	Contact your local distributor to call for service.
Ink IC Error 1 2 3 4 5 6 7 8 A B C D E F G H	The IC chip of the ink cartridge cannot be read normally.	Attach the ink cartridge(s) corresponding with the color shown on the display. If the same error message appears again on the LCD, contact your local distributor to call for service.
Ink Count Error 1 2 3 4 5 6 7 8 A B C D E F G H	The loaded ink cartridge is defective.	

Problems where error messages are given on the LCD

Warning message	Cause	Corrective measure
Waste Ink Tank No Ink Tank	The waste ink tank cannot be found.	Set the waste ink tank correctly.
Waste Ink Tank Ink Tank Is Full	Waste ink tank is full.	Remove the waste ink tank and set an empty waste ink tank.
Waste Ink Tank Ink Tank Near Full	Waste ink tank will soon full.	
REPLACE BATTERY	The battery is weaken.	Replace the battery.
Wiper Replace Wiper	Time to replace the wiper in the capping station with a new one has come and clean the bottom of the slider.	Plotting will be enabled by pressing the [REMOTE]. Then, the error message will not appear until the power is returned on. It is recommended, however, to replace the wiper with a new one as soon as possible.
Wiper Clean Wiper Shaft	The wiper guide shaft is dirty.	Clean the wiper guide shaft.
Head Height Check Head Height	The head height is incorrect.	Correct the head height. ( page 2.6)
Check Stop SW or Station Cover	The station cover is open or the stop switch is pressed.	Close the station cover or release the stop switch.
Blower Filter Replace Filter	It indicates when the filter at the right/left absorption table must be replaced.	Replace a filter. ( page 3.10)
Please Capping The Head	Head stays uncapped for more than 30 seconds.	Press the XY key or select [Station]-[Carriage Out] to cap the head. ( page 5.8)
Service Call 001	Time to replace regularly replaceable parts.	Contact your local MIMAKI distributor or call a local MIMAKI office for services. The parts may be used until new parts are delivered.
Service Call 002		

Warning message	Cause	Corrective measure
<div style="border: 1px solid black; border-radius: 10px; padding: 5px; text-align: center;"> Below Operable Temperature </div>	Temperature is below operable condition.	Adjust environmental temperature.
<div style="border: 1px solid black; border-radius: 10px; padding: 5px; text-align: center;"> Temperature Evn. Temp is Low </div>	Temperature is below guaranteed.	
<div style="border: 1px solid black; border-radius: 10px; padding: 5px; text-align: center;"> Temperature Evn. Temp is High </div>	Temperature is over below guaranteed.	

Error messages

Error messages contain error numbers.

If any error message is given on the LCD, turn off the power to the machine for while and turn it back on.

If the same error message appears again on the LCD, contact your local MIMAKI distributor or MIMAKI office to call for service.

Warning message	Cause	Corrective measure
ERROR 01 MAIN ROM	Control circuit board is defective.	Turn off the power to the machine for while and turn it back on. If the same error message appears again on the LCD, contact your local distributor to call for service.
ERROR 02 MAIN RAM		
ERROR 03 POWER +5V	Control circuit board is defective. POWER+5V POWER+35V	
ERROR 03 POWER +35V		
ERROR 04 F-ROM	Control circuit board is defective.	
ERROR 06 D-RAM		
ERROR 07 TEMP (0000)	Head connection failure is detected.	
ERROR 08 LINEAR ENCODER	Trouble with detection of linear encoder.	
ERROR 09 FPGA	Control circuit board is defective. FPGA Error HDC Error	
ERROR 19 HDC		
ERROR 10 COMMAND	The device has received data other than command data. The interface cable used is not in conformance with this plotter.	Securely connect the interface cable in position. Use an interface cable in conformance with the standard.

Warning message	Cause	Corrective measure
ERROR 11 PARAMETER	A parameter outside the range of acceptable numeric values is received.	Check the host computer output setting.
ERROR 14 COLOR COMMAND	Strange color data has been received.	
ERROR 20 I / F BOARD	Improper operation has been conducted on the operation panel.	Turn off the power to the machine for a while and then turn it on. If the same error message appears again on the LCD, contact your local distributor for service.
ERROR 21 I / F NONE	No I/F board is attached to the control board.	
ERROR 23 HOST I / F	HOST I/F Timeout error has arisen during communication between the host computer and interface board.	Check to be sure that the cable is securely connected to the host computer and interface board. Also, check to ascertain that no error has arisen on the host computer side.
ERROR 24 I / F INITIAL	Initial operation failure of the I/F board and control board.	Turn off the power to the machine for a while and then turn it on. If the same error message appears again on the LCD, contact your local distributor for service.
ERROR 30 OPERATION	An error occurs on the interface between the I/F board and the control board.	Perform a proper operation.
ERROR 34 DATA REMAIN	Settings for functions have been changed to be changed though there remains received data that has not yet been printed.	Print all pieces of received data or execute the data clear function. Then, change the settings.
ERROR 40 MOTOR X	The Xmotor has been overload.	Turn off the power to the machine for a while and then turn it on. If the same error message appears again on the LCD, contact your local distributor to call for service.
ERROR 41 MOTOR Y	The Ymotor has been overload.	
ERROR 42 X OVER CURRENT	Overcurrent error on the Xmotor has been detected.	
ERROR 43 Y OVER CURRENT	Overcurrent error on the Ymotor has been detected.	
ERROR 45 CAPPING	Incorrect height of the capping station has been detected.	

Problems where error messages are given on the LCD

Warning message	Cause	Corrective measure
ERROR 46 WIPING	The wiper position is not correct.	Turn off the power to the machine for a while and then turn it on. If the same error message appears again on the LCD, contact your local distributor for service.
ERROR 51 ORIGIN DETECTION	Origin could not be detected.	



APPENDIX

This appendix describes the specifications of the machine and components and the structure of the function menu.

Table of contents

Basic specifications	A.2
Ink specification	A.4
Consumable items	A.5
Location of safety labels	A.6
Function flowchart	A.8

Basic specifications

Item		DM3-1810S
Printing head	Method	Piezo-electric drop-on demand
	Specification	8-heads (2 x 4 lines)
	Nozzle	4 colors x 720 nozzles
	Resolution	360, 540, 720 dpi
Drawing mode		360 x 360 dpi : 2 / 4 / 8 passes, Unidirection / bidirection 360 x 540 dpi : 3 / 6 / 12 passes, Unidirection / bidirection 360 x 720 dpi : 4 / 8 / 16 passes, Unidirection / bidirection 720 x 720 dpi : 4 / 8 / 16 passes, Unidirection / bidirection
Usable ink		Specified solvent inks
Ink set		4 colors : C, M, Y, K /16 cartridges
Delivery system of ink		Supplies ink through a tube from ink cartridge Remaining ink display function (IC mounted) Ink end detecting function Ink cartridge replacement system
Capacity of ink cartridge		220 cc or 440 cc \pm 10 cc per cartridge x 4 cartridge
Medium type		Unspecified media with a flat surface, such as cardboards and tiles. Sheet-like works (cloth, canvas, PET, synthetic paper, etc.)
Work size	Max. printing area	1860 x 1010 mm
	Max. setting size	1870 x 1050 mm
	Thickness	50 mm or less
	Weight	60kg or less when load is evenly distributed
Distance accuracy	Absolute accuracy	Whichever the larger one of \pm 0.3 mm or \pm 0.15 % of the designated
	Reproducibility	Whichever the larger one of \pm 0.2 mm or \pm 0.05 % of the designated
Perpendicularity		\pm 0.5 mm / 1000 mm
Head height adjustment		1.3 – 51.3 mm variable from the table
Waste ink tank		Bottle type (5,500 cc / with tank full sensor)
Interface		IEEE1284 compliant, IEEE1394 compliant
Command		MRL-II (ESC/PV.2 base, MIMAKI original command)
Noise		during standby : Less than 55 dB (FAST-A, Front & Rear & Left & Right 1 m) during continuous printing : Less than 70 dB during discontinuous printing : Less than 70 dB
Safety Standard		VCCI-classA, FCC-classA, CBreport CE marking (EMC Directive, low-voltage Directive), ETL/cETL

Basic specifications

Item		DM3-1810S
Power	Main unit	AC 200 – 240 V \pm 10% (Auto voltage), 50/60 Hz \pm 1 Hz
	Blower for the absorption table	The specification for USA AC 200 – 230 V \pm 10%, 50/60 Hz \pm 1 Hz The specification for EU/other nations: AC 200 – 240 V \pm 10%, 50/60 Hz \pm 1 Hz
Power consumption		500VA Less than 500VA : Separate power is required for blower
Recomended Environment	Available temp.	15 °C – 30 °C
	Humidity	40 – 65 % Rh (No condensation)
	Guaranteed temp.	18 °C – 25 °C
	Temperature change	\pm 10 °C / h or less
	Dust	Equivalent to normal office level
Weight		650 Kg
Outside dimensions		3070 (W) x 2560 (D) x 1350 (H) mm or less

Leser sensor unit specifications

Item	Specifications
Type	JIS/IEC Class I Laser Product
Maximum output	3.0mW
Pulse Duration	3.5 μ S
Wave length	650nm

Ink specification

Item	Specifications	
Form	Specified solvent inks	
Type	4 colors: K, C, M, Y	
Contents of ink	SS1 ink	220 cc per cartridge
	ES3 ink	440 cc per cartridge
Shelf life	Depending on the description of the cartridge Within six months after opening the package	
Storage temperature	During storage : 0 – 25°C(average temperature of a day) During : -20 – 60°C (if it is -20(C or 60(C, within 48 hours)	



- Do not disassemble or refill the ink cartridge.

Consumable items





Consumable items listed below must be renewed at regular intervals to maintain adequate printing quality. Contact your local MIMAKI distributor or call a local MIMAKI office for services.

Wiper	10pcs	: Order No. SPA-0116
Ink absorber for the flushing tray	100pcs	: Order No. M-3
Cotton swabs	10pcs	: Wooden axis(S) cotton swab 6”

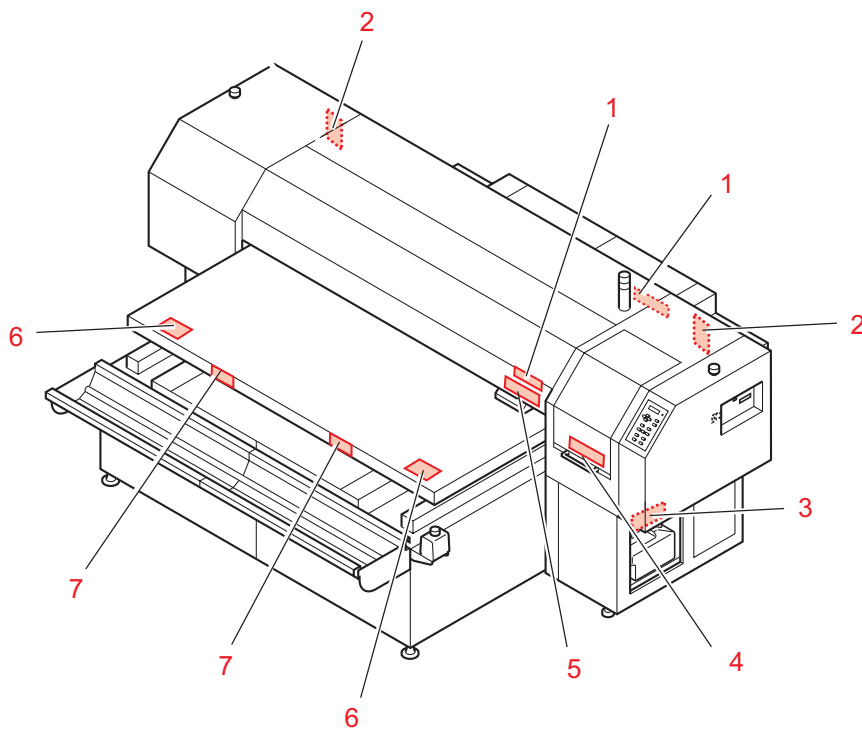
Location of safety labels

The following safety labels (10 kinds and 15 labels in total) have been attached to this machine. If any of them fall off or become illegible, contact MIMAKI local distributor for a replacement. All persons who install, operate and maintain this machine should understand and follow the safety precautions in these labels. Failure to do so can result in serious injury.



No.	Order No.	Label										
1	M903968	<div style="display: flex; justify-content: space-around;"> <div style="border: 1px solid black; padding: 5px; text-align: center;"> <p>CAUTION</p> <p>Laser radiation when open. DO NOT STARE INTO BEAM.</p> </div> <div style="border: 1px solid black; padding: 5px; text-align: center;"> <p>クラス1レーザー製品</p> <p>CLASS 1 LASER PRODUCT</p> </div> </div>										
2	LHDM-04 (Japanese) PED-04 (English)	<div style="display: flex; justify-content: space-around;"> <div style="border: 1px solid black; padding: 5px; text-align: center;"> <p>⚠ 危険</p>  <p>巻き込まれ危険 重傷の恐れあり。</p> </div> <div style="border: 1px solid black; padding: 5px; text-align: center;"> <p>⚠ DANGER</p>  <p>Do not get caught in the machine serious injury can result.</p> </div> </div>										
3	M901469	<table border="1" style="width: 100%; border-collapse: collapse;"> <tr> <th style="text-align: center;">△ 注意</th> <th style="text-align: center;">△ 注意</th> <th style="text-align: center;">△ CAUTION</th> </tr> <tr> <td style="text-align: center;"> 廃墨は有毒性的、 請取扱い方法除去。 </td> <td style="text-align: center;"> 廃インクに毒性はありま せん。地域の条例に従い、 廃棄してください。 </td> <td style="text-align: center;"> Inks are not poisonous. You can dispose them according to a municipal ordinance. </td> </tr> </table>	△ 注意	△ 注意	△ CAUTION	廃墨は有毒性的、 請取扱い方法除去。	廃インクに毒性はありま せん。地域の条例に従い、 廃棄してください。	Inks are not poisonous. You can dispose them according to a municipal ordinance.				
△ 注意	△ 注意	△ CAUTION										
廃墨は有毒性的、 請取扱い方法除去。	廃インクに毒性はありま せん。地域の条例に従い、 廃棄してください。	Inks are not poisonous. You can dispose them according to a municipal ordinance.										
4	M901607	<table border="1" style="width: 100%; border-collapse: collapse;"> <tr> <td style="width: 25%; font-size: 8px;"> 噴印時、请不要打开盖子。如果 打开盖子的话喷印就会停止。停止之 后再度喷印时，请将数据再从计算 机中输出。 </td> <td style="width: 25%; font-size: 8px;"> 作印中、このカバーを開けないでく ださい。途中で作印が終了してしま います。再度、作印する場合、 もう一度コンピュータからデータを 送信してください。 </td> <td style="width: 25%; font-size: 8px;"> Do not open this cover during printing. The carriage will stop and ruin the print. </td> <td style="width: 25%; font-size: 8px;"> Diese Abdeckung während des Druckens nicht öffnen. Der Wagen hält sonst an, wodurch der Druck ruiniert wird. </td> <td style="width: 25%; font-size: 8px;"> Ne pas ouvrir ce couvercle pendant l'impression. Le chariot peut s'arrêter, abîmant l'impression. </td> </tr> </table>	噴印時、请不要打开盖子。如果 打开盖子的话喷印就会停止。停止之 后再度喷印时，请将数据再从计算 机中输出。	作印中、このカバーを開けないでく ださい。途中で作印が終了してしま います。再度、作印する場合、 もう一度コンピュータからデータを 送信してください。	Do not open this cover during printing. The carriage will stop and ruin the print.	Diese Abdeckung während des Druckens nicht öffnen. Der Wagen hält sonst an, wodurch der Druck ruiniert wird.	Ne pas ouvrir ce couvercle pendant l'impression. Le chariot peut s'arrêter, abîmant l'impression.					
噴印時、请不要打开盖子。如果 打开盖子的话喷印就会停止。停止之 后再度喷印时，请将数据再从计算 机中输出。	作印中、このカバーを開けないでく ださい。途中で作印が終了してしま います。再度、作印する場合、 もう一度コンピュータからデータを 送信してください。	Do not open this cover during printing. The carriage will stop and ruin the print.	Diese Abdeckung während des Druckens nicht öffnen. Der Wagen hält sonst an, wodurch der Druck ruiniert wird.	Ne pas ouvrir ce couvercle pendant l'impression. Le chariot peut s'arrêter, abîmant l'impression.								
5	M901549	<table border="1" style="width: 100%; border-collapse: collapse;"> <tr> <th style="text-align: center;">△ 注意</th> <th style="text-align: center;">△ 注意</th> <th style="text-align: center;">△ CAUTION</th> <th style="text-align: center;">△ ACHTUNG</th> <th style="text-align: center;">△ ATTENTION</th> </tr> <tr> <td style="font-size: 8px;"> 滾転時、請勿將手插入 前面外蓋的内部。 </td> <td style="font-size: 8px;"> キャリッジ動作中は、フロント カバーの中に指を入れない てください。 </td> <td style="font-size: 8px;"> -MOVING CARRIAGE- Do not put fingers inside this area </td> <td style="font-size: 8px;"> -Beweglicher Wagen- Finger nicht in diesen Bereich bringen. </td> <td style="font-size: 8px;"> -CHARIOT MOBILE- Ne pas mettre de doigts dans cette zone. </td> </tr> </table>	△ 注意	△ 注意	△ CAUTION	△ ACHTUNG	△ ATTENTION	滾転時、請勿將手插入 前面外蓋的内部。	キャリッジ動作中は、フロント カバーの中に指を入れない てください。	-MOVING CARRIAGE- Do not put fingers inside this area	-Beweglicher Wagen- Finger nicht in diesen Bereich bringen.	-CHARIOT MOBILE- Ne pas mettre de doigts dans cette zone.
△ 注意	△ 注意	△ CAUTION	△ ACHTUNG	△ ATTENTION								
滾転時、請勿將手插入 前面外蓋的内部。	キャリッジ動作中は、フロント カバーの中に指を入れない てください。	-MOVING CARRIAGE- Do not put fingers inside this area	-Beweglicher Wagen- Finger nicht in diesen Bereich bringen.	-CHARIOT MOBILE- Ne pas mettre de doigts dans cette zone.								
6	M903226 (Japanese) M904325 (English)	<p style="text-align: center; background-color: #f0f0f0;">このテーブルに腰掛けたり、寄り掛かる等の負荷をかけないで下さい。 テーブルが変形し、故障の原因や、画質に影響が出る可能性があります。</p> <p style="text-align: center; background-color: #ffff00;">Do not sit or lean on the table. Do not put any pressure on one side. These will deform the table and may cause damage and affects the printing.</p>										
7	LHCM-02 (Japanese) PEC-02 (English)	<div style="display: flex; justify-content: space-around;"> <div style="border: 1px solid black; padding: 5px; text-align: center;"> <p>⚠ 注意</p>  <p>はさまれ注意 ■ 運転中は可動部に手を触れ ないこと。 ■ カバーを閉じたまま運転し ないこと。 ■ 運転中はカバーの内側に手 を入れないこと。</p> </div> <div style="border: 1px solid black; padding: 5px; text-align: center;"> <p>⚠ CAUTION</p>  <p>RISK OF GETTING TRAPPED do not insert hands</p> </div> </div>										

Function flowchart

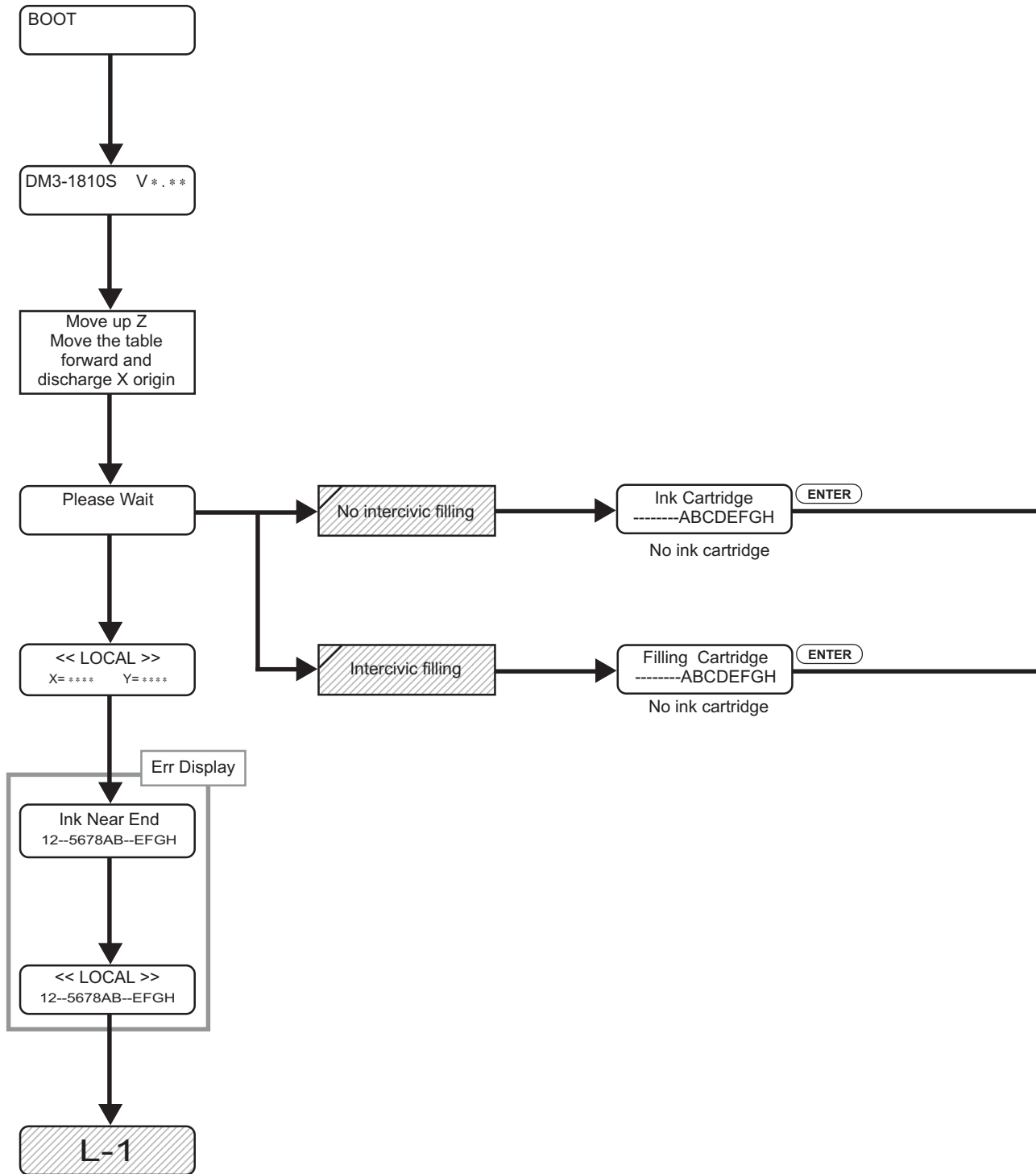

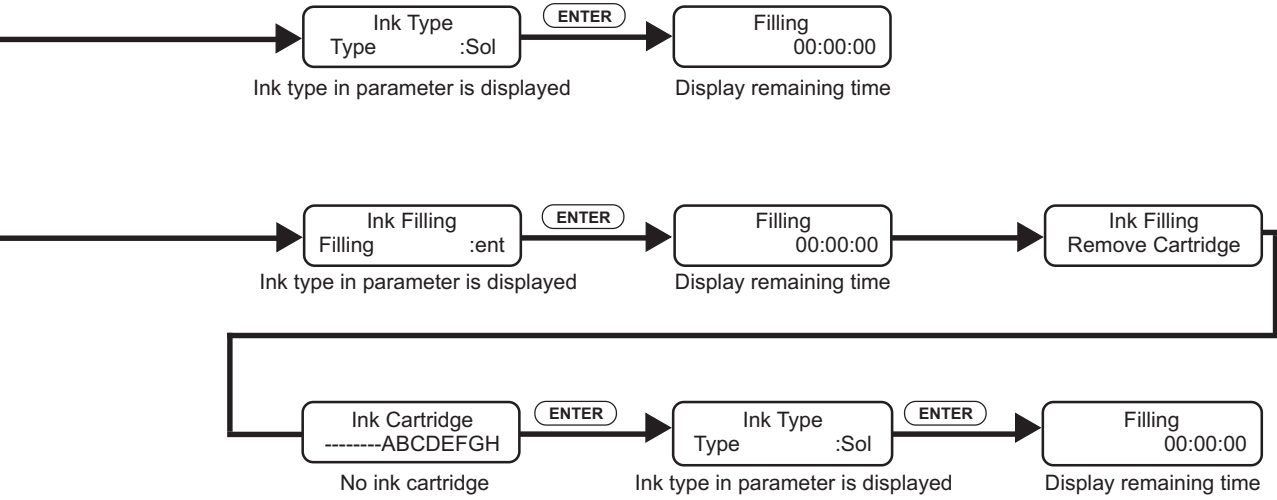

L-1

X(Δv)

X(<v>)

Origin Setup
X=**** Y=****
XY(Δv<v>):JOG MODE

ENTER

Origin Setup
**** Origin ****

Z(Δv)

Head Height
*. *mm
Z(Δv<v>):JOG MODE

ENTER

Head Height
*. *mm

VIEW

VIEW
<ENT>

ENTER

VIEW

** VIEW **

DATA CLEAR

DATA CLEAR
<ENT>

ENTER

DATA CLEAR

** CLEAR **

TEST

TEST PRINT
<ENT>

ENTER

TEST

** PRINT **



L-2

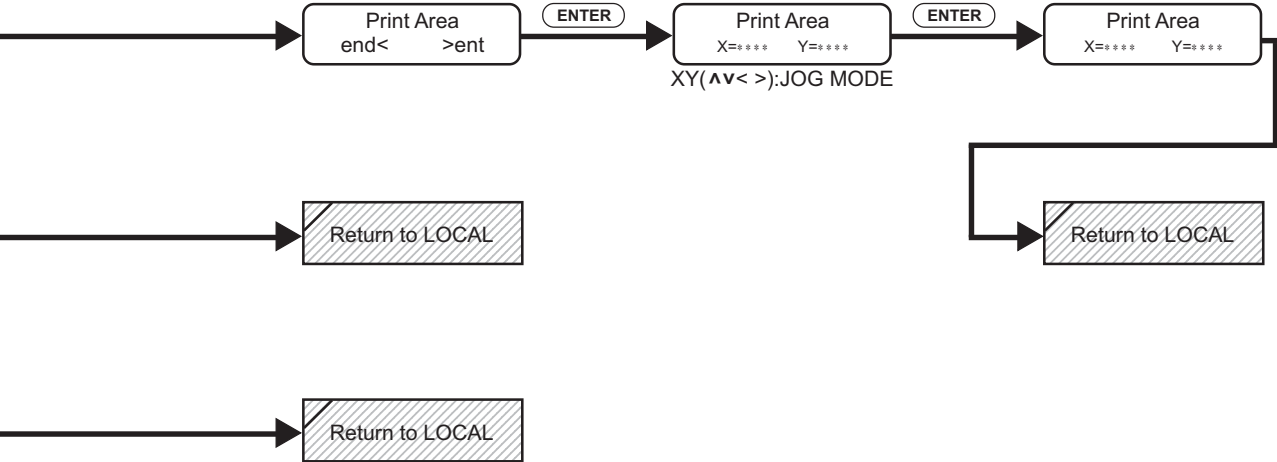

L-2

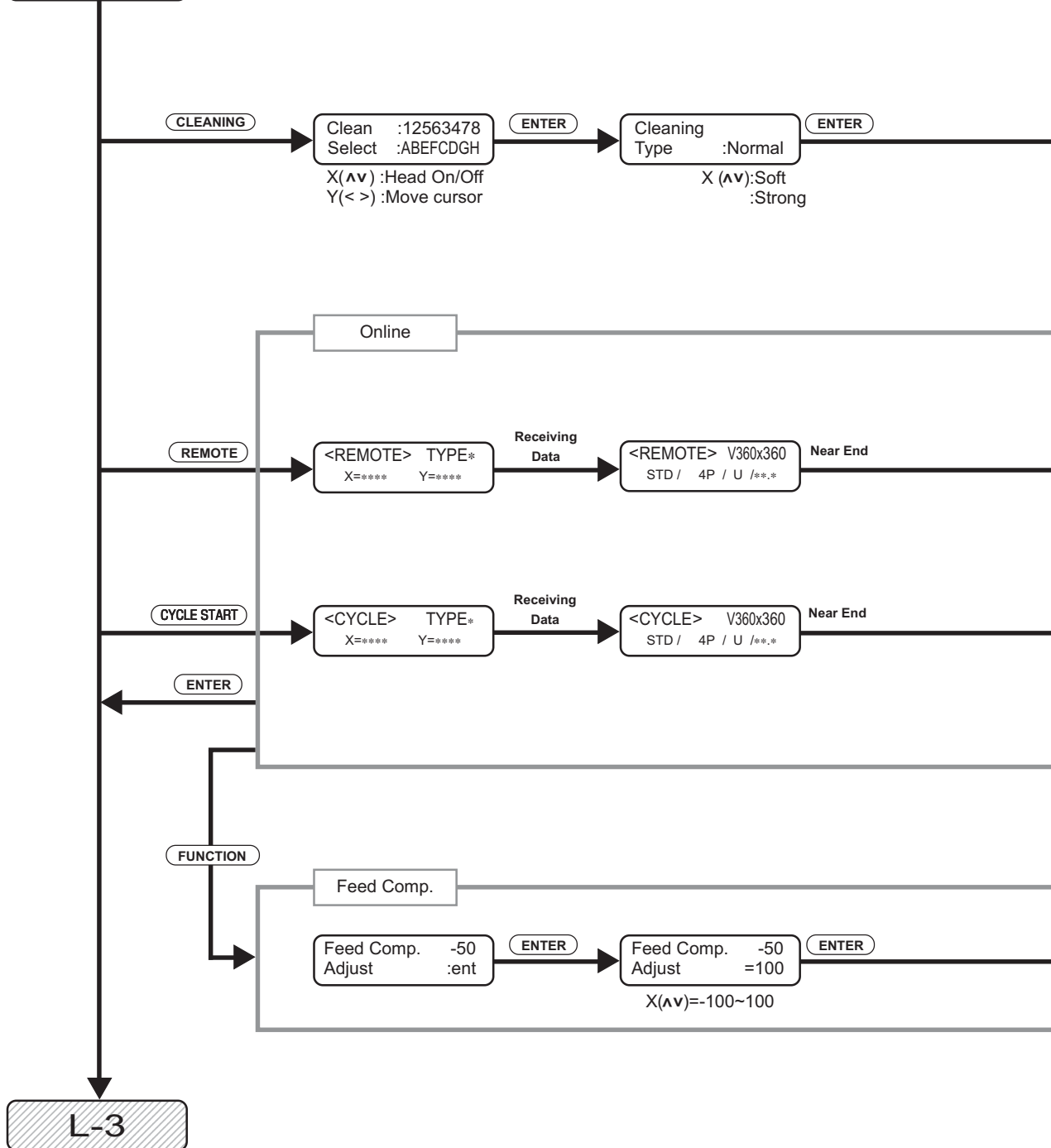

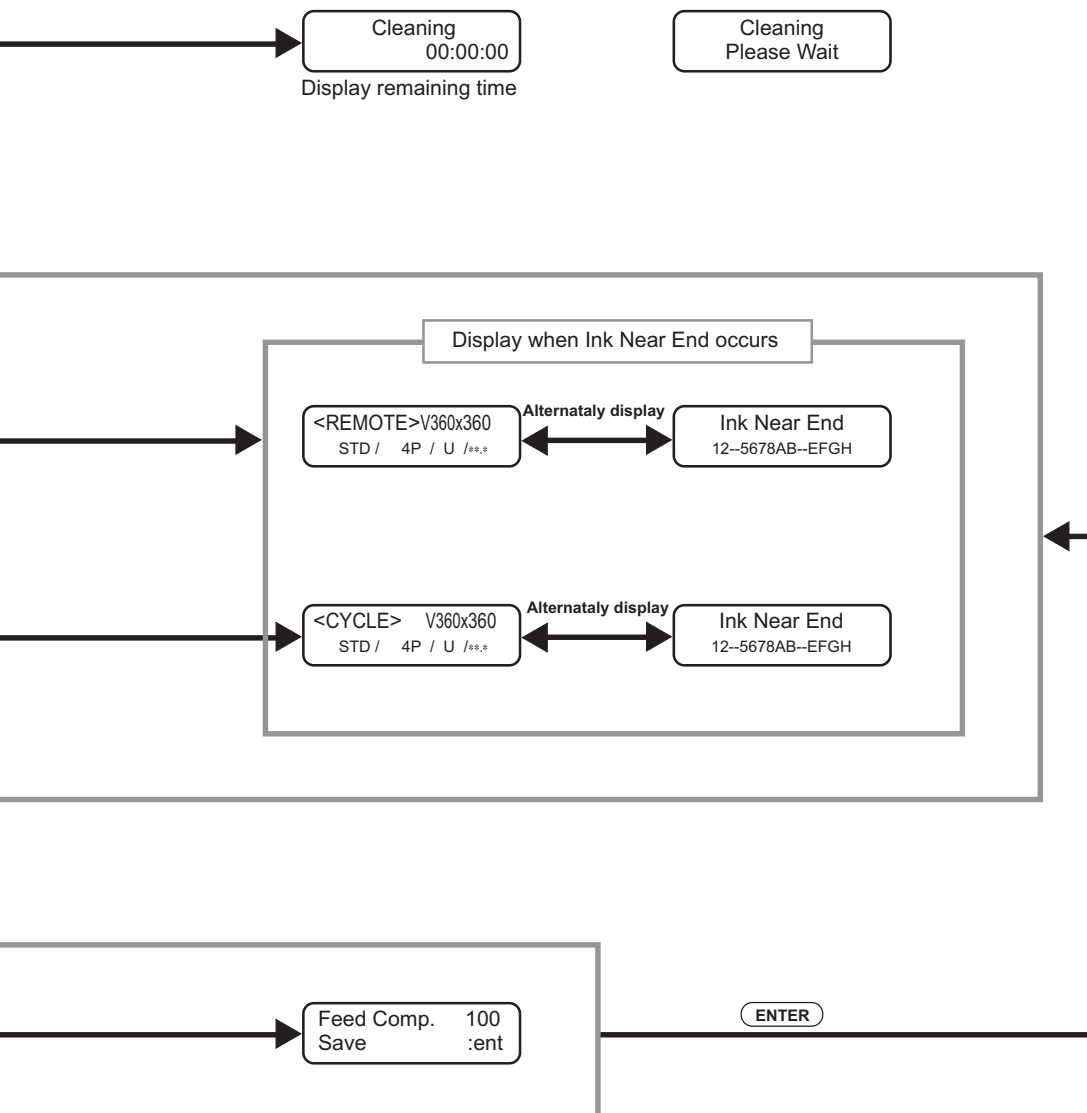

L-3

Guidance display

ENTER

Ink Level
9999999999999999

ENTER

Head Height
**.*mm

ENTER

The remaining ink are display
with level 0 to 9

Display current head height

FUNCTION

S-1

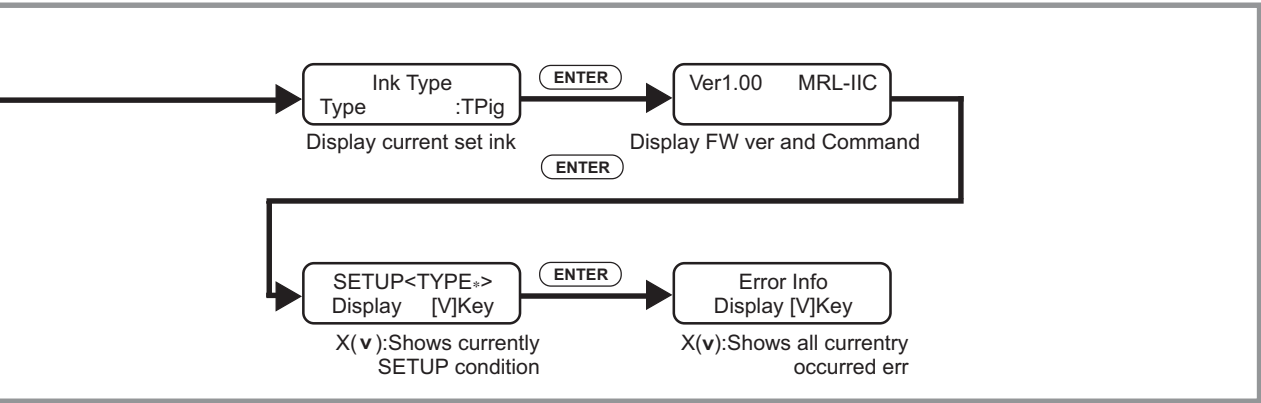

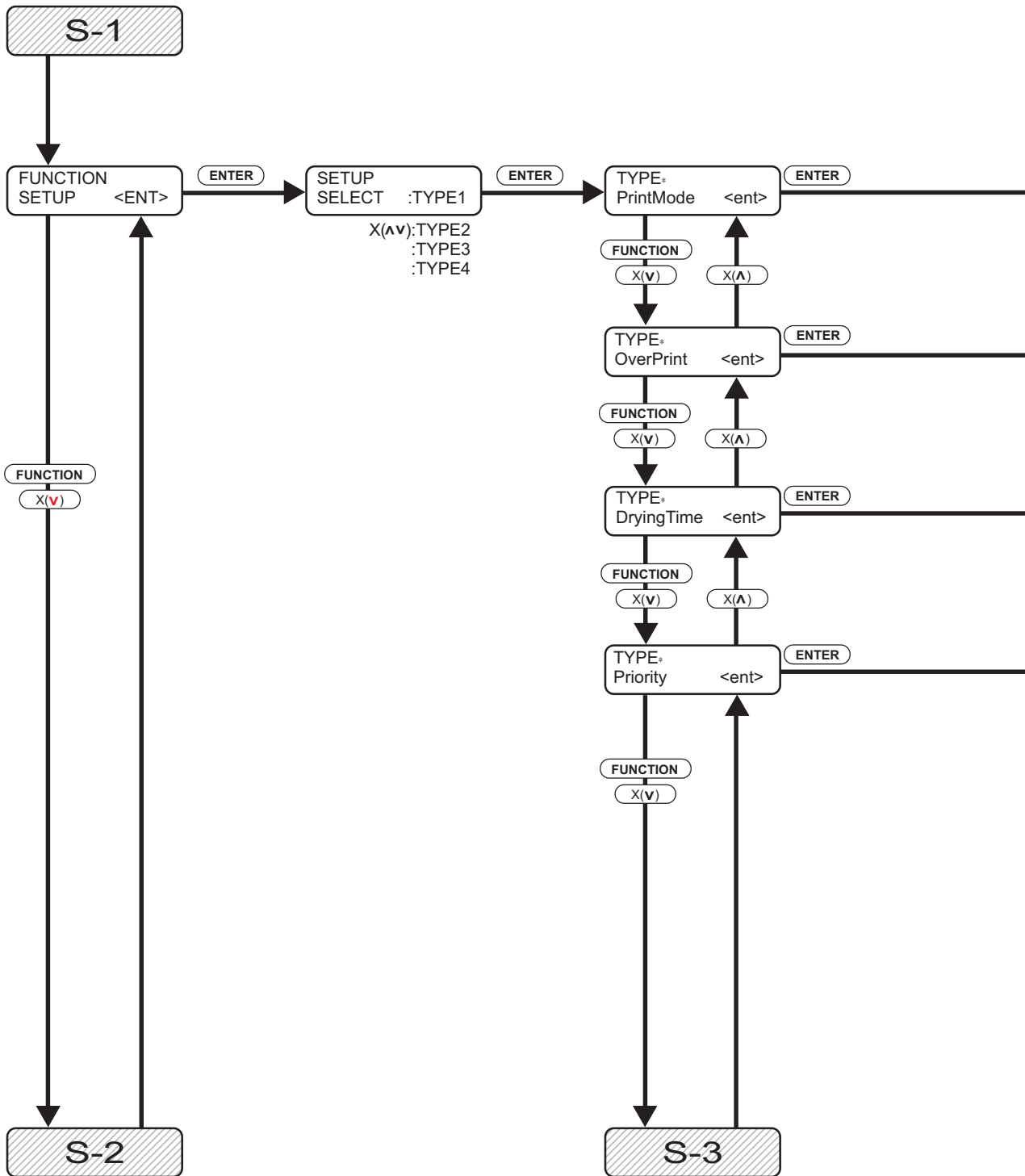

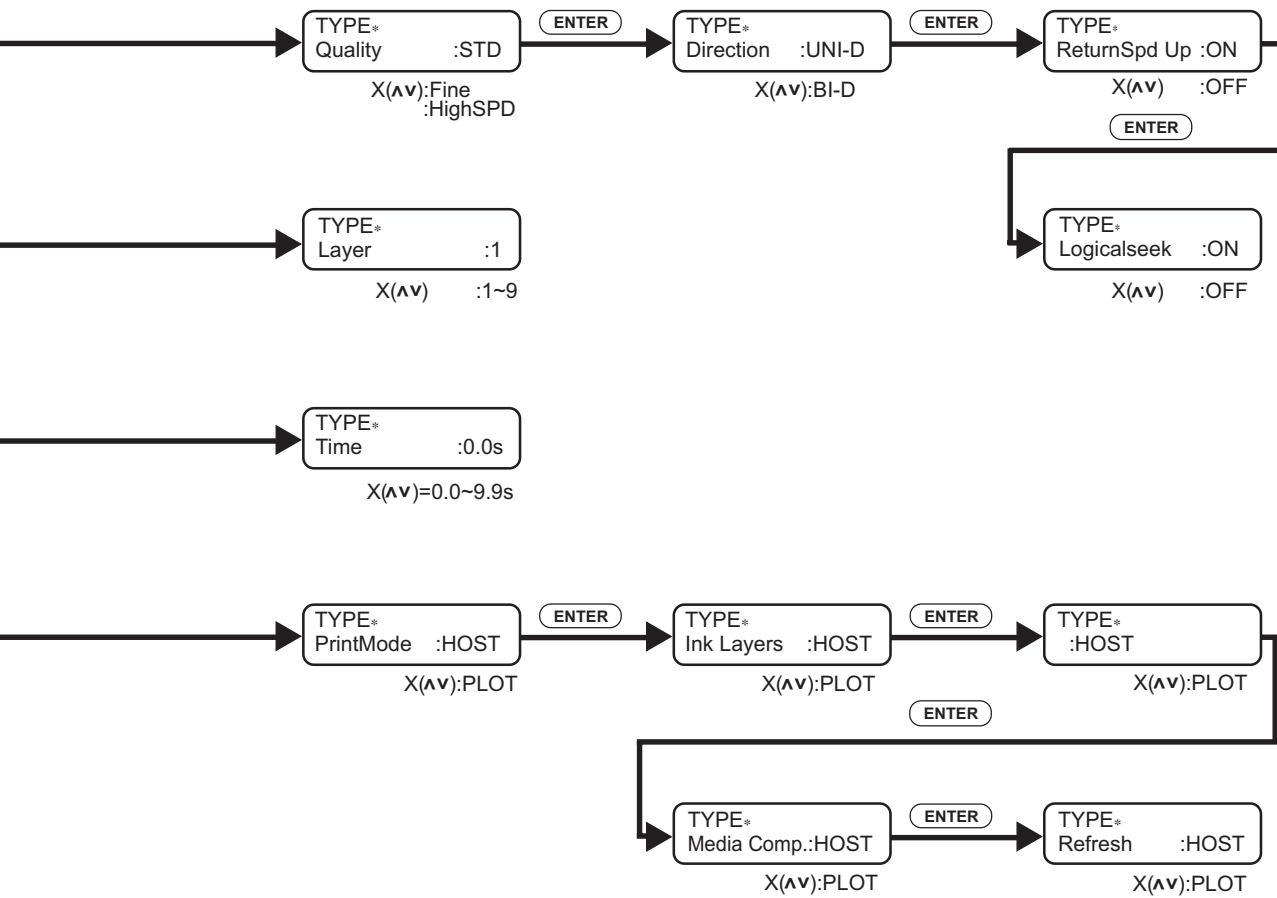

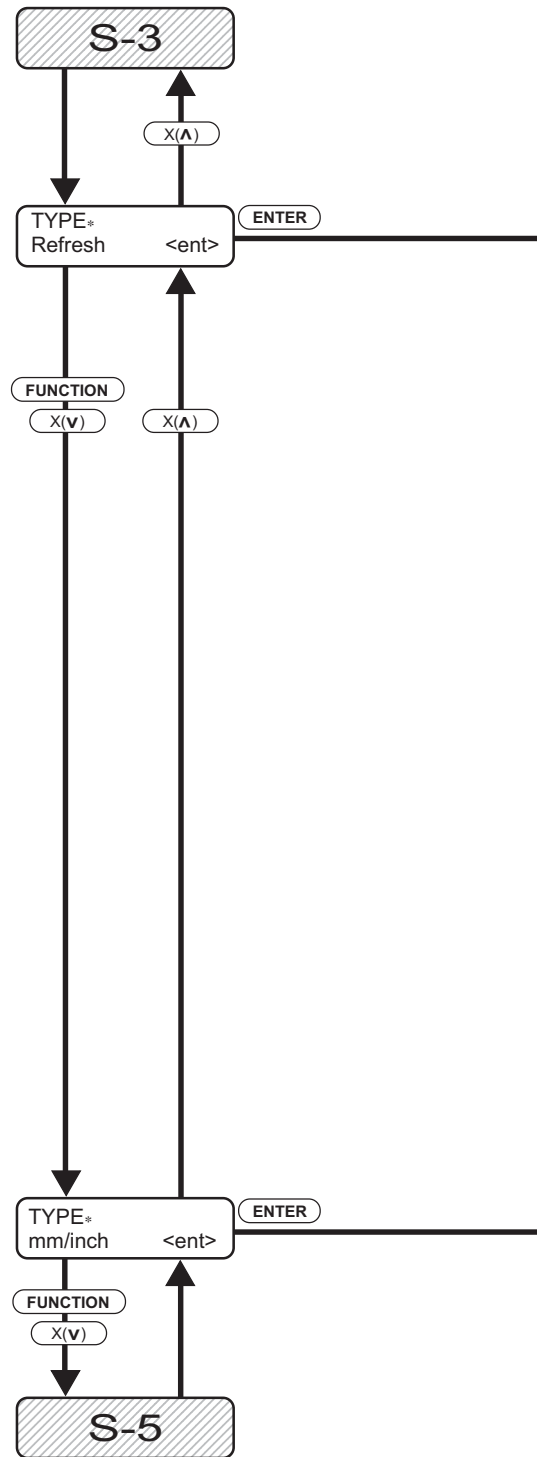
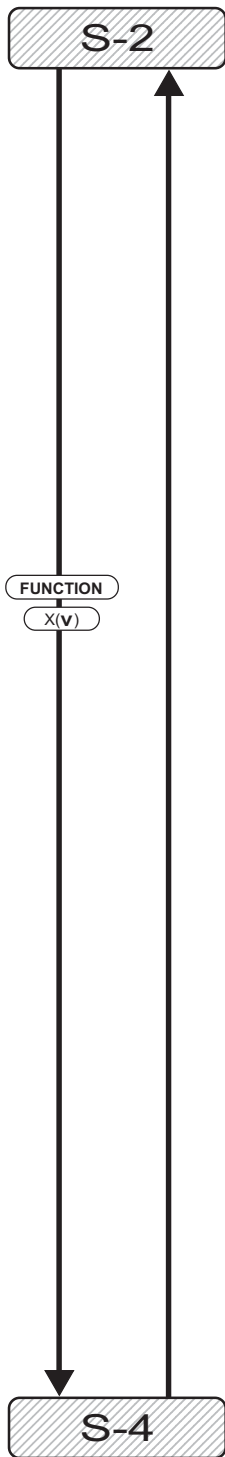

TYPE*
Refresh :Level3
X(ΛV):Level0~Level3

TYPE*
mm/inch :mm
X(ΛV) :inch

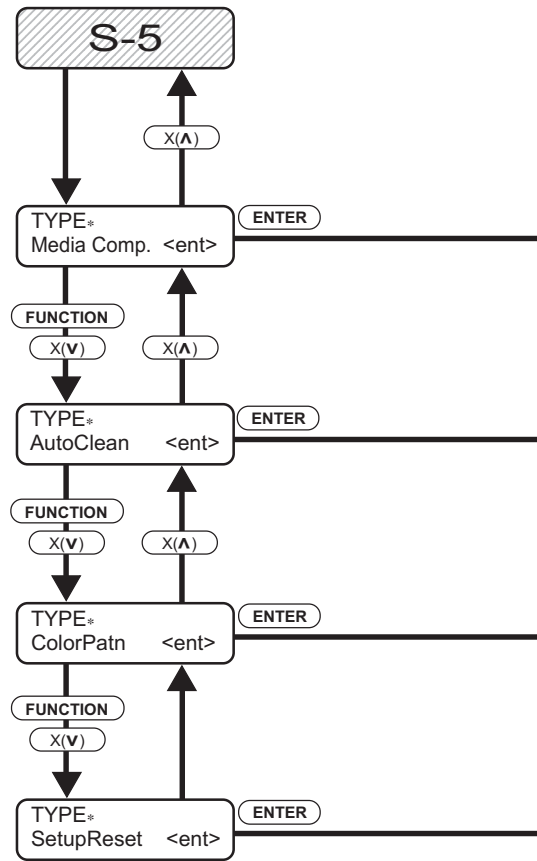
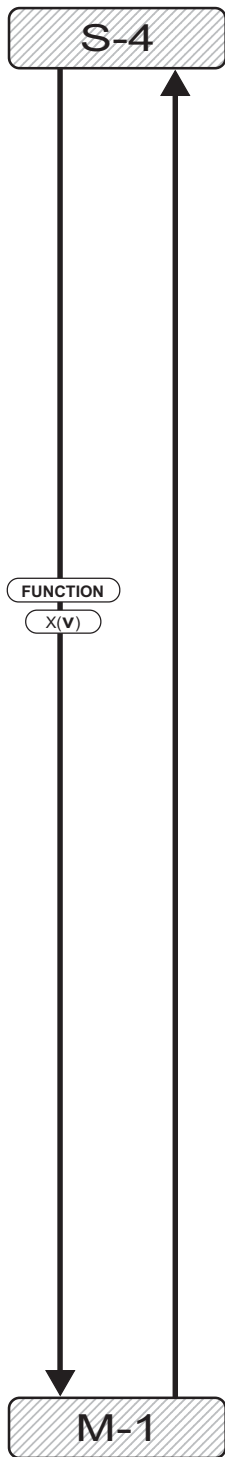

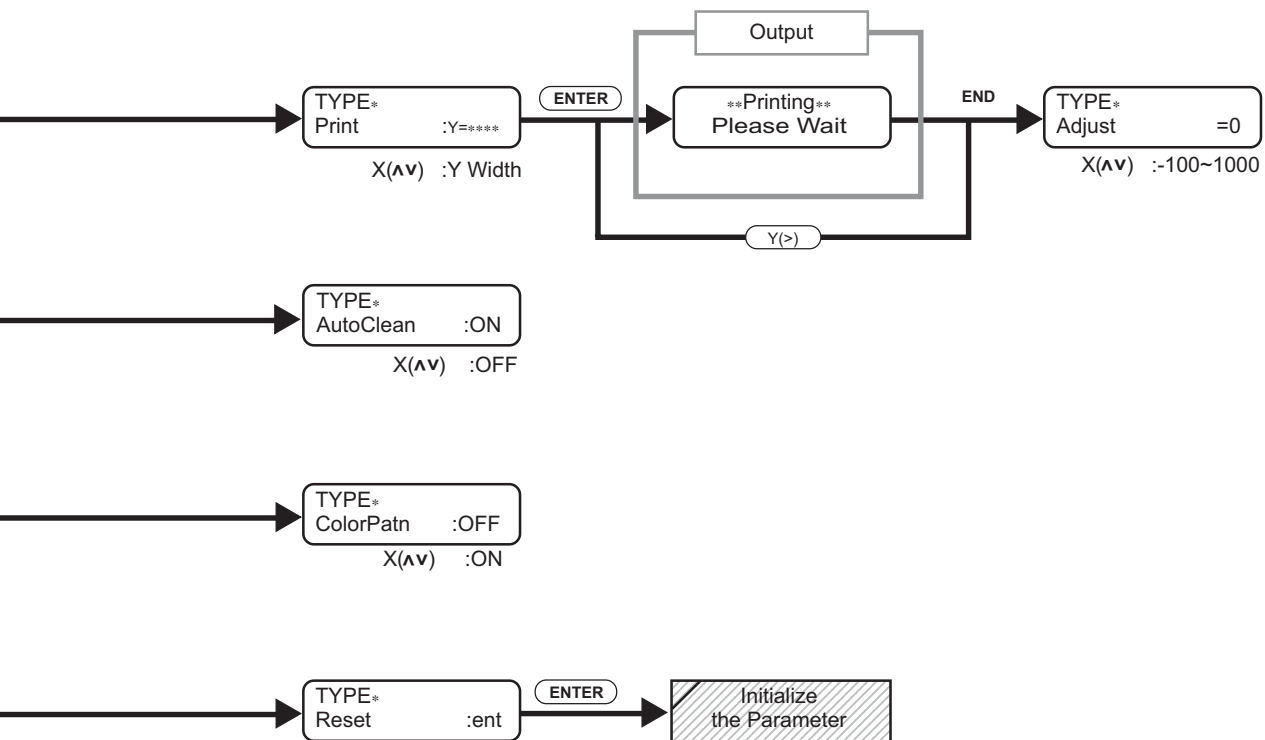

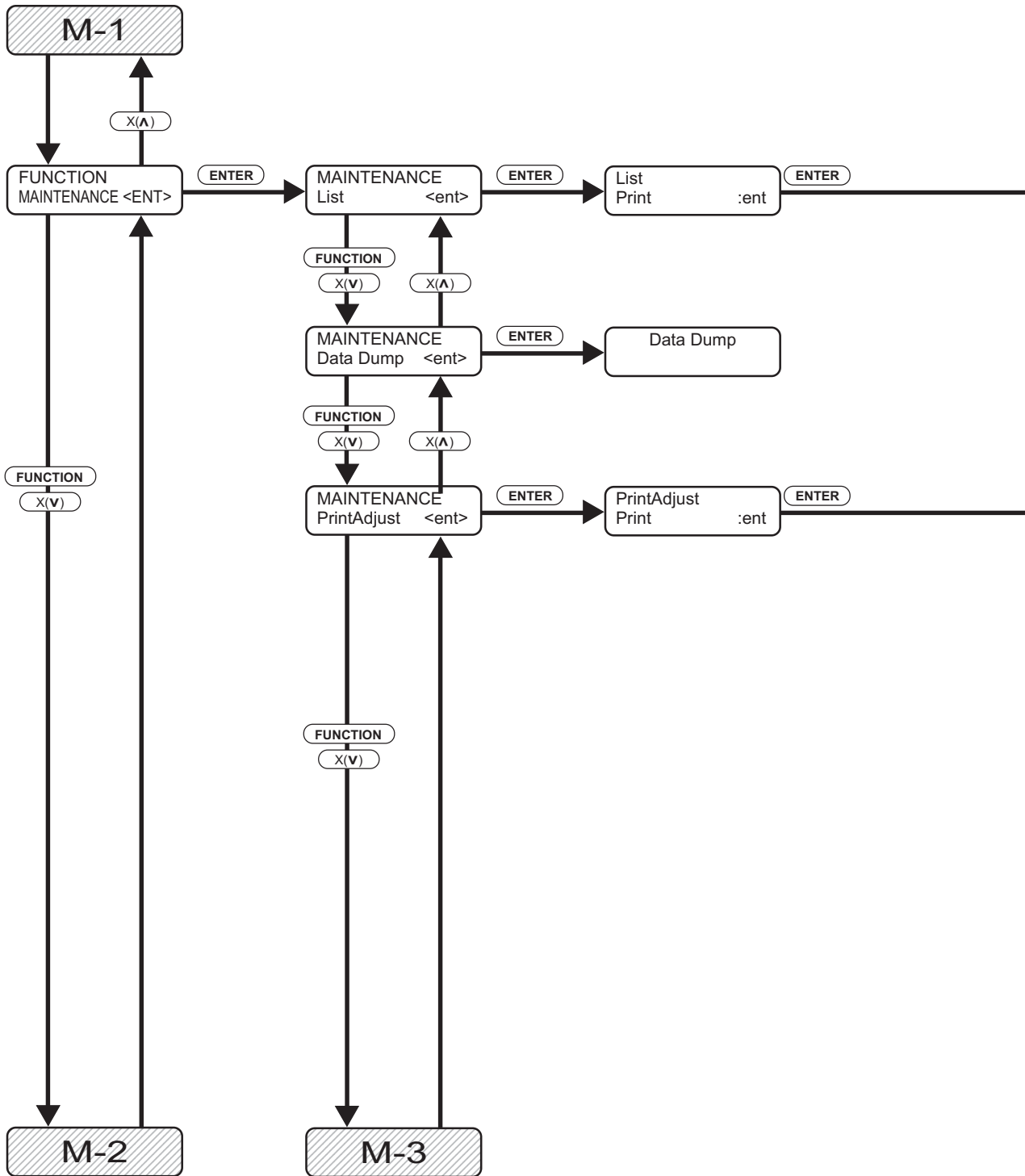

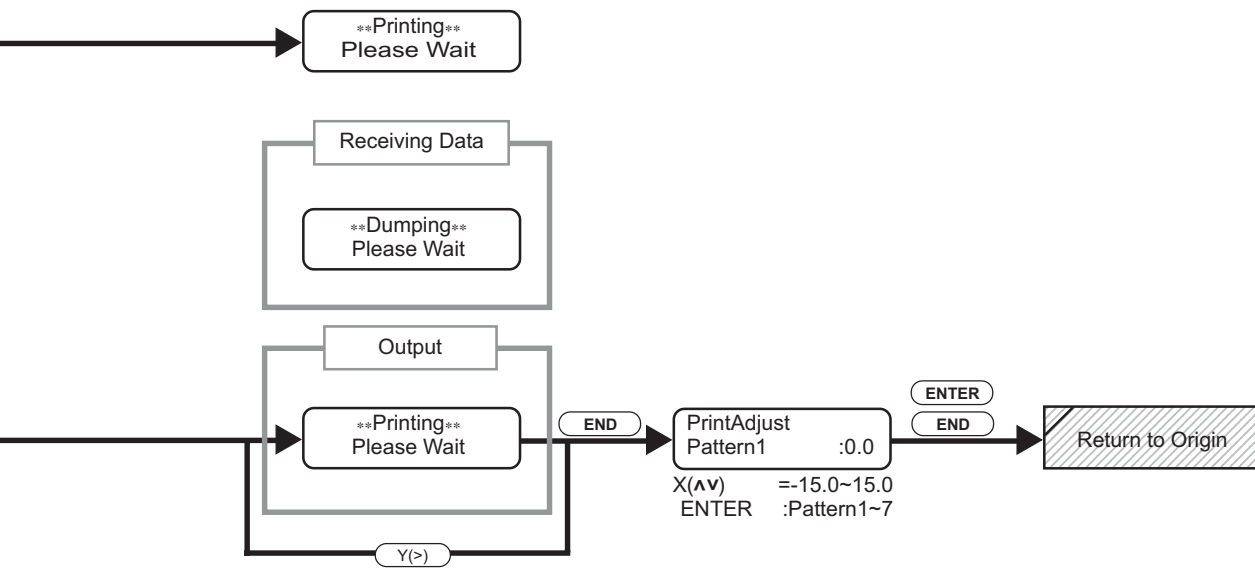

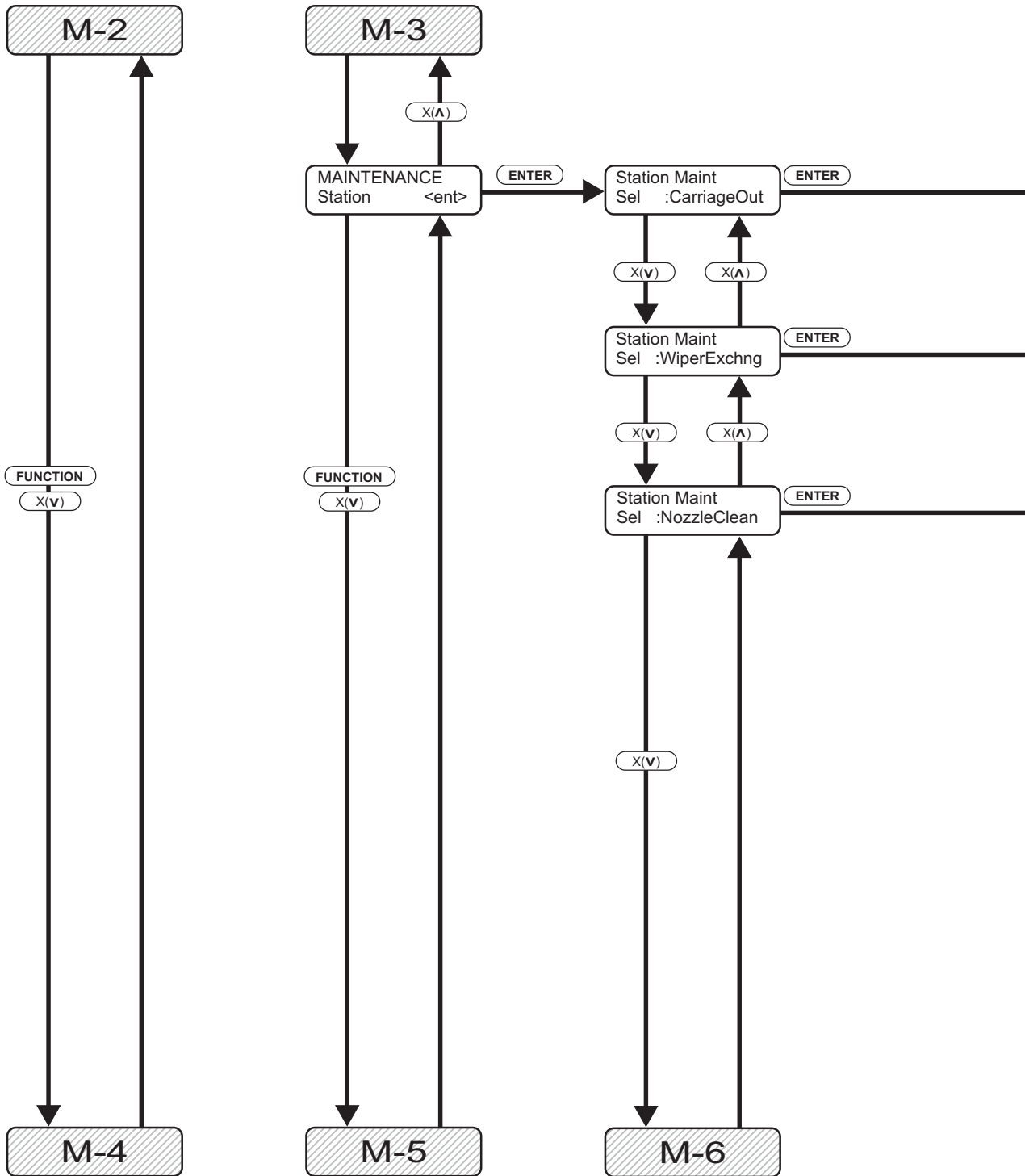

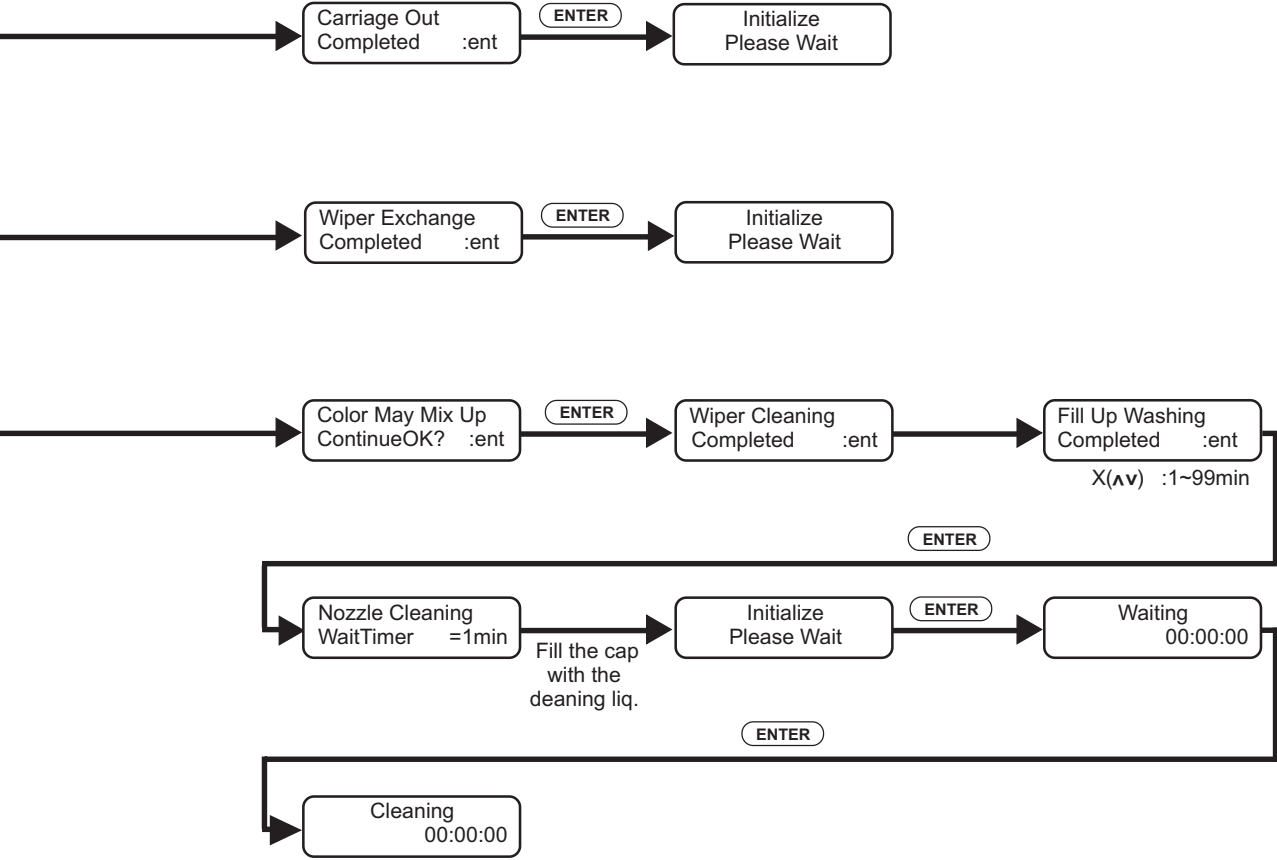

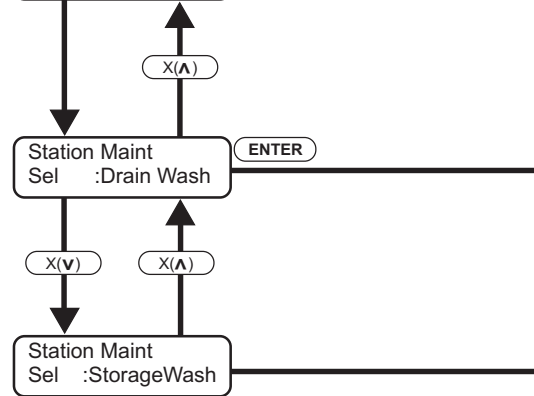
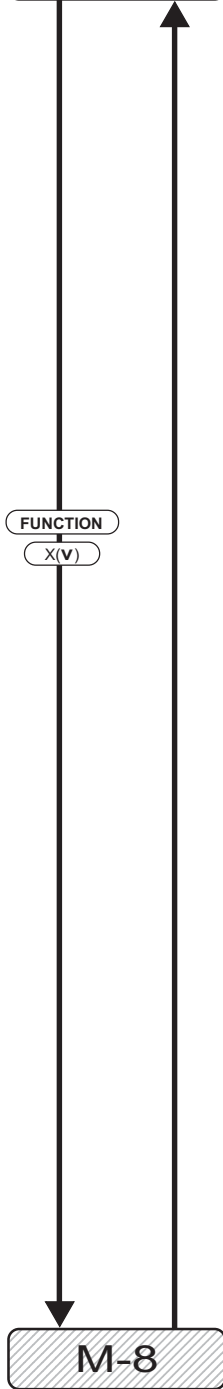
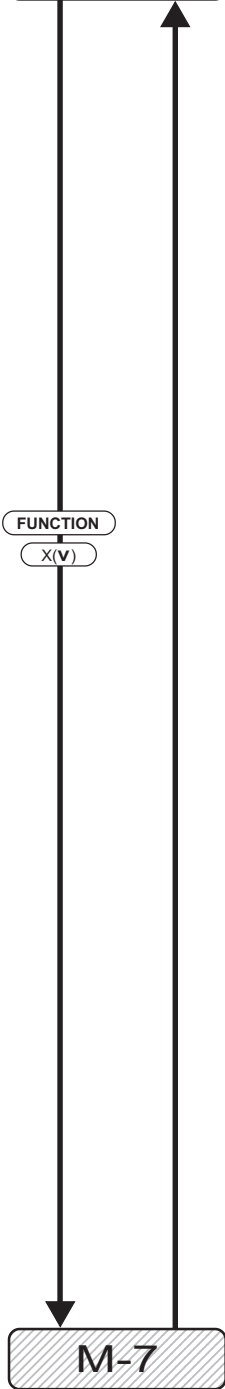

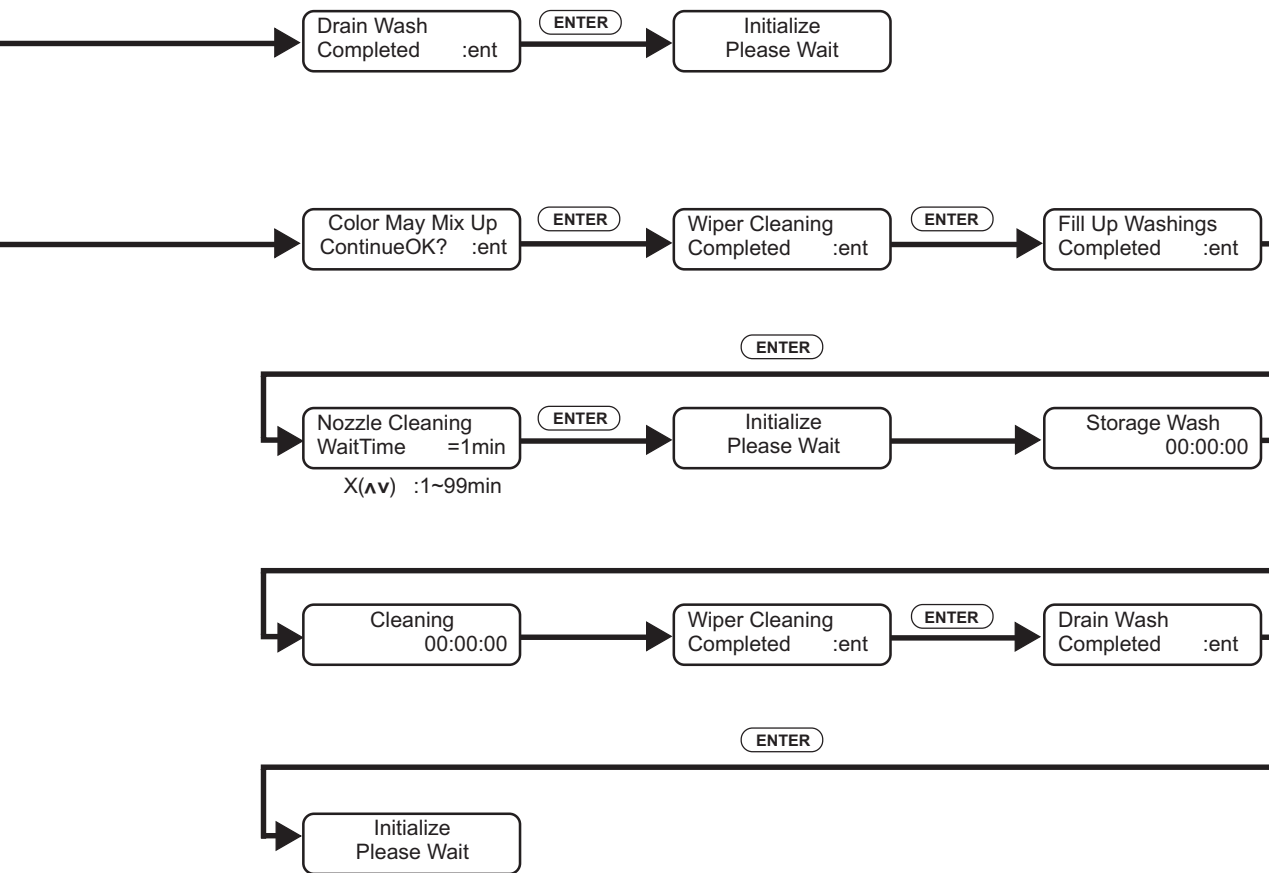

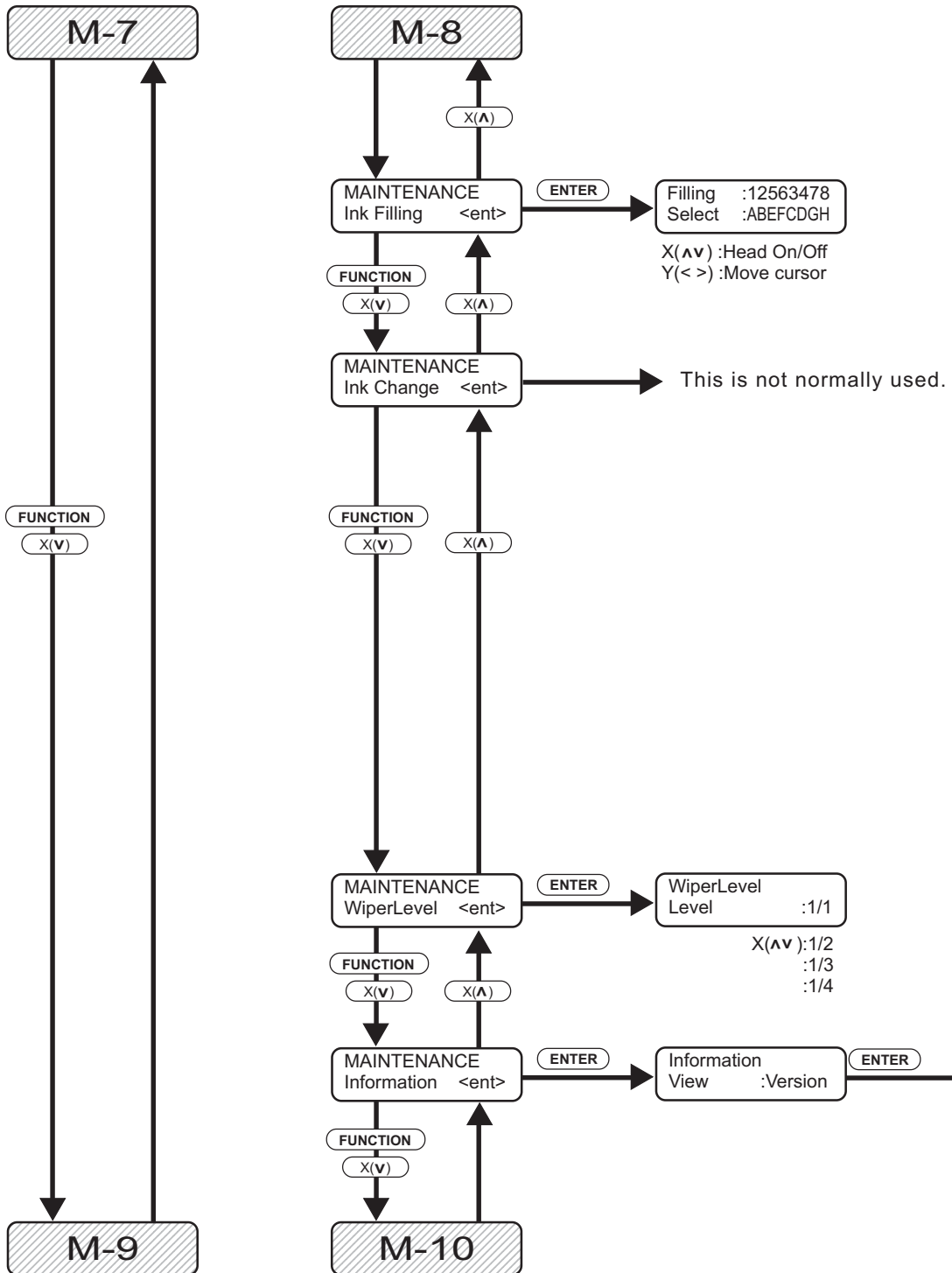





MAIN Ver1.00
I/F Ver **.**

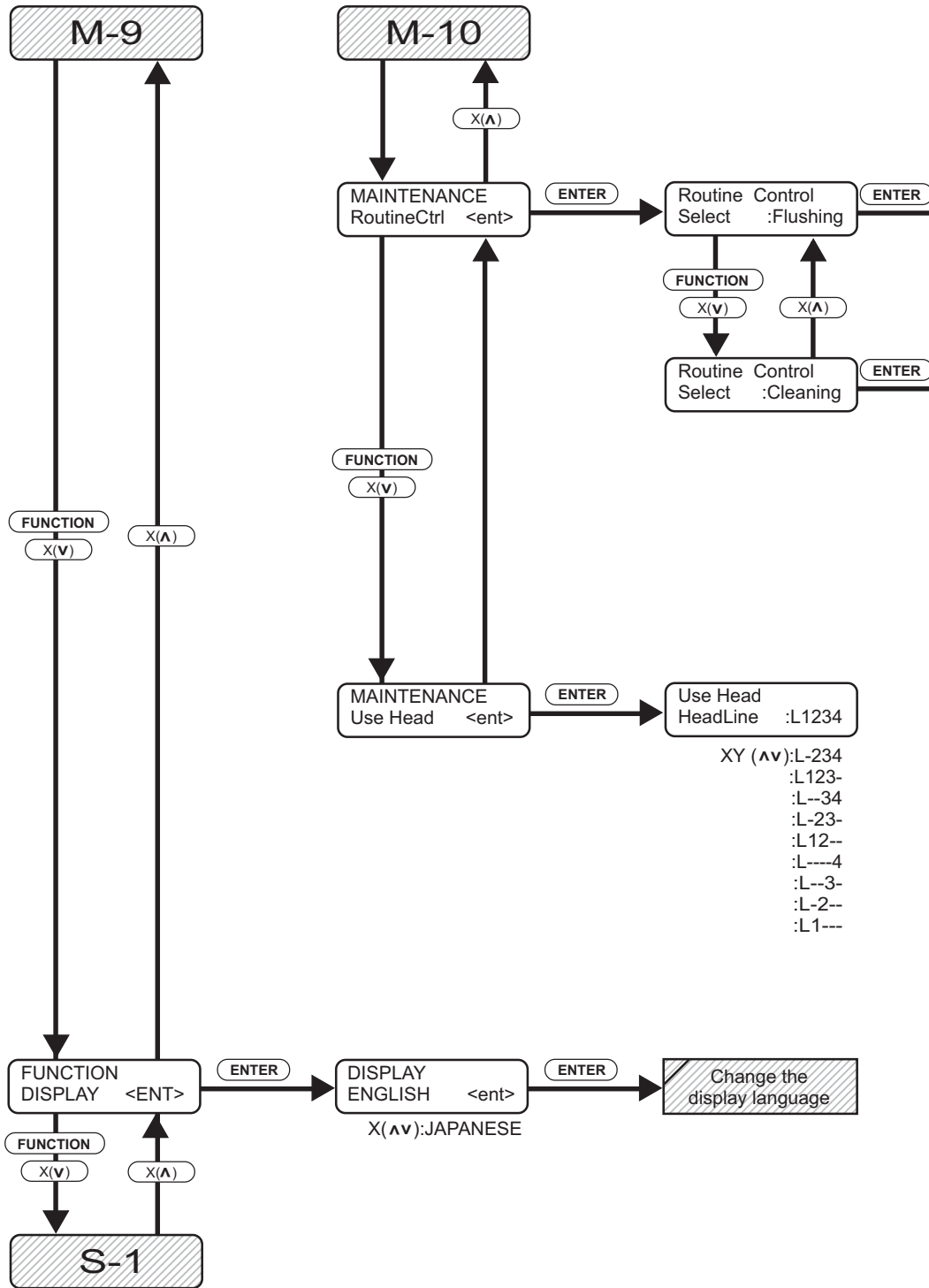

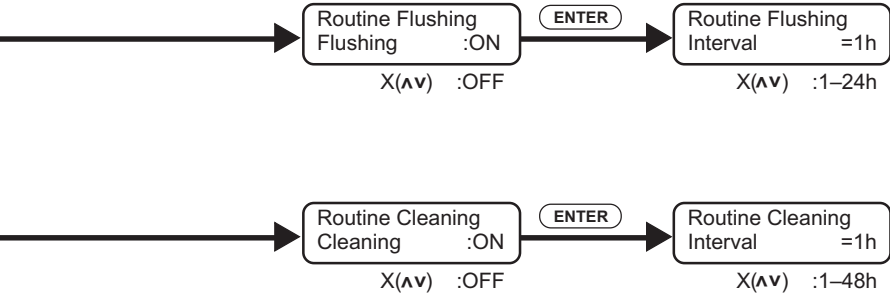

Mimaki