

UJF-605C

UV INKJET PRINTER

Operation Manual



- Never look at the UV lamp being lit with your naked eyes, or it may cause pain in your eyes or visual impairment.



- This device is equivalent to Class II laser device. Never look at the laser light, or it may cause pain in your eyes or visual impairment.

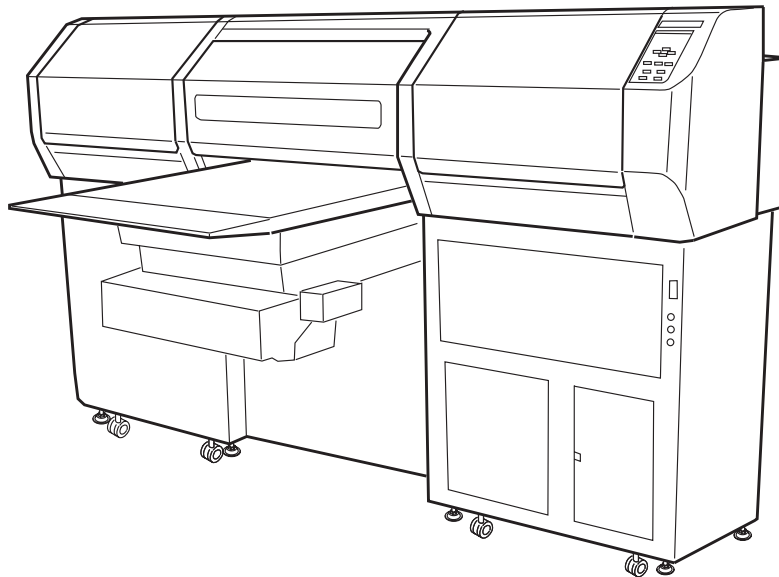

DISCLAIMER OF WARRANTY:

THIS LIMITED WARRANTY OF MIMAKI SHALL BE THE SOLE AND EXCLUSIVE WARRANTY AND IS IN LIEU OF ALL OTHER WARRANTIES, EXPRESS OR IMPLIED, INCLUDING , BUT NOT LIMITED TO, ANY IMPLIED WARRANTY OF MERCHANTABILITY OR FITNESS, AND MIMAKI NEITHER ASSUMES NOR AUTHORIZES DEALER TO ASSUME FOR IT ANY OTHER OBLIGATION OR LIABILITY OR MAKE ANY OTHER WARRANTY OR MAKE ANY OTHER WARRANTY IN CONNECTION WITH ANY PRODUCT WITHOUT MIMAKI'S PRIOR WRITTEN CONSENT. IN NO EVENT SHALL MIMAKI BE LIABLE FOR SPECIAL, INCIDENTAL OR CONSEQUENTIAL DAMAGES OR FOR LOSS OF PROFITS OF DEALER OR CUSTOMERS OF ANY PRODUCT.

Requests

- This Operation Manual has been carefully prepared for your easy understanding, however, please do not hesitate to contact a distributor in your district or our office if you have any inquiry.
- Description contained in this Operation Manual are subject to change without notice for improvement.

- Generally, names and designations referred to in this Operation Manual are trade marks or registered trade marks of the manufacturers or suppliers.

Reproduction of this manual is strictly prohibited.
All Rights Reserved. Copyright © 2012 MIMAKI ENGINEERING CO., LTD.

FCC Statement (USA)

This equipment has been tested and found to comply with the limits for a Class A digital device, pursuant to Part 15 of the FCC Rules. These limits are designed to provide reasonable protection against harmful interference when the equipment is operated in a commercial environment. This equipment generates, uses and can radiate radio frequency energy and, if not installed and used in accordance with the instruction manual, may cause harmful interference to radio communications.

Operation of this equipment in a residential area is likely to cause harmful interference in which cause the user will be required to correct the interference at his own expense.



- In the case where MIMAKI-recommended cable is not used for connection of this device, limits provided by FCC rules can be exceeded. To prevent this, use of MIMAKI-recommended cable is essential for the connection of this device.

INTERFERENCE TO TELEVISIONS AND RADIOS

The product covered by this Instruction Manual produces low radio waves while it is in operation. The product can interfere with radios and televisions if set up or commissioned under improper conditions. The product is not guaranteed against any damage to specific-purpose radio and televisions.

The product's interference with your radio or television will be checked by turning on/off the power switch of the product.

In the event that the product is the cause of interference, try to eliminate it by taking one of the following corrective measures or taking some of them in combination.

- Change the direction of the receiving antenna or the feeder of your radio/television.
- Change the installing direction of the product.
- Move the receiver away from the product.
- Use a power line for the receiver that is not shared with the product.

LASER SAFETY

This Model is certified as a Class II laser product under the U.S. Department of Health and Human Services Radiation Performance standard according to the Radiation Control for Health and Safety Act of 1968. This means that this Model does not produce hazardous laser radiation.

CDRH REGULATION

The Center for Devices and Radiological Health for the U.S. Food and Drug Administration Implement regulations for laser products. The sentence of "This product complies with 21 CFR chapter I and subchapter J" indicates compliance with the CDRH regulations and is labeled on the product when marketed in the United States. This Model is equivalent to Class II laser device according to CDRH Regulation.

This product complies with 21 CFR chapter I and subchapter J



- Use of controls, adjustments or performance of procedures other than those specified in this manual may results in hazardous radiation exposure.

Foreword

Congratulations on your purchase of a MIMAKI "UJF-605C" model of UV ink jet printer.

UV Inkjet Printer UJF-605C uses ultraviolet ray curing ink (UV ink), which has been recently developed.

Read this Operation Manual carefully and make the most effective use of your printer. Before starting to operate the printer, be sure to read this Operation Manual carefully .

On this operation manual

- This Operation Manual describes the operation and maintenance of Model UJF-605C Color Ink Jet Printer (hereinafter referred to as the device).
- Please read and fully understand this Operation Manual before putting the machine into service. It is also necessary to keep this Operation Manual on hand.
- Make arrangements to deliver this Operation Manual to the person in charge of the operation of this device.
- This Operation Manual has been carefully prepared for your easy understanding, however, please do not hesitate to contact a distributor in your district or our office if you have any inquiry.
- Description contained in this Operation Manual are subject to change without notice for improvement.
- In the case where this Operation Manual should be illegible due to destruction or lost by fire or breakage, purchase another copy of the Operation Manual from our office.

Table of contents

Foreword	iii
On this operation manual	iii
Features	viii
For safe operation	ix
Pictorial signs	ix
Example of pictorial signs	ix
Precautions in use	xiv
How to read this Operation Manual	xvii
Display on the LCD and Indication of the Keys	xvii
Structure of this Operation Manual	xviii

Chapter 1 Before use

Installing the device	1-2
Where to install the device	1-2
Configuration and function	1-4
The front	1-4
The rear	1-5
Operation panel	1-6
Sub-panel	1-7
Carriage	1-8
Capping station	1-8
Flushing tray	1-9
Connecting the cables	1-10
Connecting the interface cable	1-10
IEEE 1394 interface is used	1-10
IEEE 1284 interface is used	1-10
Connecting the power cable	1-11
UV unit and UV irradiation device	1-12
UV unit	1-12
UV irradiation device	1-12
About functions of UV lamp status indicator	1-13
Mode for the UV lamp status indicator	1-14
Installing the ink cartridges	1-15
Relationships between ink station and head row	1-15
Ink cartridge and ink station	1-16
Precautions in handling the ink cartridge	1-16
Regular maintenance for white ink	1-16
Types of media that can be used	1-17
Sizes of media that can be used	1-17
Precautions in handling the media	1-17
Menu mode	1-18

Chapter 2 Basic operations

Operation	2-2
Turning the power on	2-3
Displaying the information	2-4
Opening / closing covers	2-5
Initial setting of inks	2-6
Setting the media	2-7
Types of media that can be used	2-7
Front UV light-resistant curtain	2-7
before setting media	2-9
Entering [Head Gap] value	2-9
Selecting [GAP CHECK]- [SELECT] for head gap adjustment	2-10
Checking head gap	2-13
Establishing the origin and the print area	2-15
Initial value	2-15
Setting printing origin	2-16
Setting printing origin using jog keys	2-16
Setting precisely the origin ([FUNCTION] - [ORIGIN])	2-17
Checking and solving nozzle clogging	2-19
Normal pattern	2-19
Printing an image from source data	2-21
Starting the printing operation	2-21
Printing repeatedly (COPY)	2-23
Interrupting the printing operation	2-24
Printing multi editions repeatedly (multi editions copy)	2-24
Clear the number of copies	2-26
To replenish ink, set a new ink cartridge in the ink station	2-27
Ink cartridge trouble	2-28
Learning the detail of ink cartridge trouble	2-28
Turning the power off	2-29

Chapter 3 Daily care

Routine maintenance	3-2
When the device is left unused for a long period of time	3-2
Notes on cleaning	3-2
Maintenance for frame components	3-2
In case defective printing is not resolved	3-3
Cleaning flushing tray	3-5
When the waste ink tank becomes full	3-7
Replacing waterin water heater tank	3-8

Precautions for replacing or exchanging	3-8
Precautions in handling the Anti-freezing liquid	3-8
Regular maintenance for white ink	3-13
Cleaning or replacing filter	3-15
Cleaning the undersurface of the carriage	3-16
Cleaning of the head guard plate	3-16
Cleaning of the nozzle side	3-18

Chapter 4 Setting function

Application functions	4-2
Before setting	4-2
Checking the menu mode	4-2
Basic operations of menus	4-3
Registering two or more printing conditions at a time (Selecting a type)	4-4
Changing the type	4-4
Setup functions	4-5
Setting the operation of the registration mark detection [MARK SENSOR]	4-8
Set the operation of the registration mark detection [MARK SETUP]	4-8
Check the sensor for the registration mark detection [MARK Check]	4-12
Turning off UV Irradiation device [UV LAMP OFF]	4-14
Change the display language [DISPLAY]	4-15

Chapter 5 Maintenance

Maintenance of the device	5-2
Invoking a maintenance function	5-2
Setup functions	5-2
Drawing setup conditions [LIST]	5-3
When media thickness is changed [Print Adjust]	5-4
Cleaning the station interior [Station]-[CarriageOut]	5-6
If nozzles are clogged even after the cleaning function is executed	5-7
Regular wiping function [INT. WIPING]	5-8
Changing the ink set [INK SET]	5-9
Changing to 6-color ink set	5-9
Changing to 8-color ink set with addition of spot color	5-11
Changing white ink to spot color	5-12
Ink exchanging procedure	5-14

Select a head for small amount cleaning [HEAD MAINTENANCE]	5-15
Replacing UV Lamp	5-16
Checking UV lamp irradiation duration	5-16
Replacing UV lamp	5-16
Resetting UV lamp irradiation duration	5-17
Setting UV lamp off duration	5-18
Checking UV ink curing level	5-19
Adjusting UV light level	5-21
UV illumination level check	5-23
UV illumination level check	5-23
Prevent the nozzle clogging of spot color [SP.REFRESH]	5-28
Displaying device information [INFORMATION]	5-29
Set the type of the cap rubber [CAP RUBBER]	5-30

CHAPTER 6 When abnormal conditions are encountered

Before taking a phenomenon as a sign of failure	6-2
The device cannot be energized	6-2
The device cannot perform printing	6-2
Display [WATER NOT READY] OR [UV NOT READY]	6-2
If image quality declines	6-3
Troubles for which error messages are given on the LCD	6-4
Errors accompanied by warnings	6-4
Error messages	6-6

Appendix

Basic specifications	A-2
Specification for ink	A-3
Position of the warning label	A-4
Function flowchart	A-7

Features

The features of the device are described below. Together with the method of operation of the device explained in this manual, they help you understand how to use the device properly.

Ultraviolet ray curing ink used

Use of ultraviolet ray curing ink (UV ink), which has been recently developed, enables direct printing onto media.

High-speed interface used

Use of high-speed interface IEEE1394 allows high-speed data reception from computers.

Curing and fixing of ink enabled after printing

Use of an ultraviolet curing device (UV lamp) enables curing and fixing of ink after printing.

Wide printable area

The allowable print area is 600 mm (scan) x 500 mm (feed).

Applicable to media with maximum thickness of 50 mm

This unit is applicable to media with maximum thickness of 50 mm.

Vacuum table equipped

This unit is equipped with a suction-type blower table for fixing media.

For safe operation

Pictorial signs

Pictorial signs are used in this Operation Manual for safe operation of and in prevention of damages to the device. Pictorial signs and their meanings are given below. Read and fully understand before reading the text.



- Indicates the case where it is assumed that misuse of the machine, ignoring this sign, as this may cause fire or poisoning. Be sure to read this manual for proper operation.



- Indicates the case where it is assumed that misuse of the machine, ignoring this sign, can cause damage only to property.



- The symbol "💡" indicates helpful information that will facilitate the use of the device.

Example of pictorial signs



- The symbol "⚠" indicates the case where some phenomenon that requires a CAUTION sign (including "DANGER" and "WARNING" signs) exists. A concrete precaution (precaution against an electric shock in the case of the sketch given on the left) is shown in the illustration.



- The symbol "⊘" indicates a prohibited behavior. A concrete illustration of prohibition (disassembly is prohibited in the sketch given on the left) is shown in or next to the illustration.



- The symbol "●" indicates a thing that is forced to be done and instruction that is forced to be followed. A concrete illustration of instruction (the removal of a plug from the receptacle is instructed in the sketch given on the left) is drawn in the illustration.

WARNING



- Be sure to setup the appropriate air-moving system in case of using the device in a closed room or a room with bad ventilation.

***Cautions for constructing exhaust outlet**

Please observe the following things to prevent the device.

1. The shape of the exhaust outlet depends on your building environment. The exhaust outlet area is required more than half of the duct entrance area.
2. If mounting a valve on the exhaust outlet, be sure to open the valve when using the device.

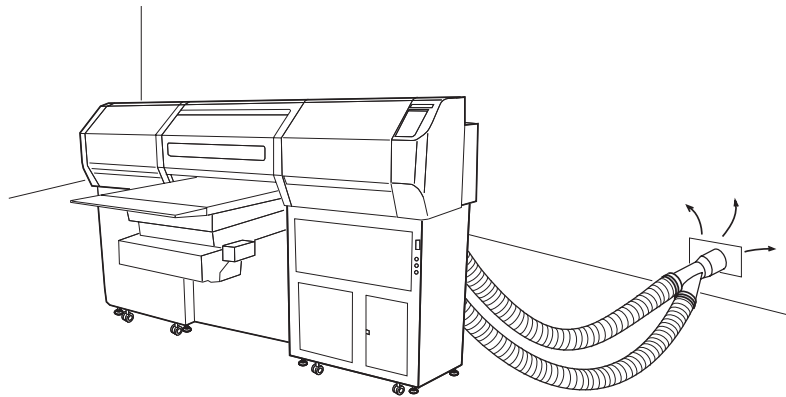

- The ink used for this device falls into the category of UN No.3082 and UN Class 9. Since the ink is flammable, never use fire when using the device.



- When cleaning the ink station and head, be sure to wear the supplied goggle and gloves since you may get ink or washing liquid in your eyes.



- If anyone drinks ink or washing liquid in mistake, get the person to vomit and see a doctor immediately. Do not allow him or her drink vomit. Then, contact the Poison Control Center.





- If you absorb a lot of vapor and feel bad, immediately move to a location where fresh air is present and then keep yourself warm and quiet. Then, consult a doctor as soon as possible.



- Discard the waste ink according to the local regulations of the area this unit is used.

Never do the following

 WARNING	
<p>Do not disassemble or remodel the device</p> <ul style="list-style-type: none"> Never disassemble or remodel the main unit of the printer and the ink cartridge. Disassembling/remodeling any of them will result in electric shocks or breakdown of the device. 	<p>Handling of ink cartridges</p> <ul style="list-style-type: none"> Store ink cartridges and waste ink tank in a place that is out of the reach of children. If ink settles on the skin or clothes, immediately wash it off with detergent or water. <p>If you get ink in your eyes, immediately wash your eyes with a lot of clean water for at least 15 minutes. In this case, also wash the backside of eyelids to rinse ink away completely. Then, consult a doctor as soon as possible.</p> <ul style="list-style-type: none"> Some of the ingredients (UV Curing initiator) have toxic consequences to aquatic life. Avoid leak into water system or sewage containing water.
<p>Do not use the device in damp places</p> <ul style="list-style-type: none"> Avoid damp environments when putting the device into service. Do not splash water onto the device. High-humidity or water will give rise to fire, electric shocks or breakdown of the device. 	<p>Grounding work</p> <ul style="list-style-type: none"> This unit requires grounding work to prevent electrical shock. Carry out the grounding work.
<p>Abnormal event occurs</p> <ul style="list-style-type: none"> If the device is used under an abnormal condition where the device produces smoke or unpleasant smell, fire or electric shocks can result. Be sure to turn off the power switch immediately and detach the plug from the receptacle. Check first to be sure that the device no longer produces smoke, and contact a distributor in your district for repair. Never repair your device by yourself since it is very dangerous for you to do so. 	<p>Wearing protective devices</p> <ul style="list-style-type: none"> When cleaning the suction nozzle and/or cap, which may scatter ink, be sure to wear safety glasses and gloves, or ink and washing liquid might enter your eyes or ink and washing liquid put on your hands might make your hands rough.
<p>Laser sensor</p> <ul style="list-style-type: none"> This device is equivalent to Class II laser device according to CDRH Regulation. LASER CAUTION Label for CDRH regulation shown below is provided with the device. <div style="text-align: center;">  </div> <p>To avoid causing pain in your eyes or visual impairment, do not review the laser beam through a lens or the other optical observation system.</p> <ul style="list-style-type: none"> Never look at the laser light, or it may cause pain in your eyes or visual impairment. 	<p>Opening / closing covers</p> <ul style="list-style-type: none"> This unit is equipped with covers. When opening or closing the covers, there is a possibility that your fingers or arms or a part of your body will be pinched. If it should occur, it may cause bruises or, in the worst case, crushing to death. When opening or closing the covers, take care so that your body or a part of it is never pinched.

WARNING

Power supply and voltage



- This unit contains parts applied high voltage. Carrying out electrical work by those unauthorized for that work is prohibited.



- To prevent electrical shock, be sure to set OFF the main power circuit breaker and disconnect the power plug before carrying out maintenance. For some units, capacitors may take one minute for discharging; therefore, start maintenance work three minutes after setting OFF the main power circuit breaker and disconnecting the power plug.



- The main power circuit breaker should be set ON only by personnel with sufficient knowledge about operations of this unit.



- Be sure to carry out grounding work to prevent electrical shock.



- Use the unit under the power specifications given.

Be sure to connect the power cable plug to a convenient outlet grounded, or fire or electric shock might occur.

Handling of UV lamp



- The UV lamp is made of glass and should not be dropped, hit against anything, given excessive force or scratched, or it may cause damage to the UV lamp.



- Do not use the UV lamp in an ambience with a possibility of catching fire (gasoline, combustible gas spray, thinner, lacquer, powder dust, etc.). In addition, do not put paper or cloth near or on the UV lamp, or it may cause fire.



- Do not break a used UV lamp; put it in a container and discard likewise ordinary fluorescent lamps according to the local regulations. Breaking a UV lamp will cause glass fragments to be scattered.



- In rare cases, the UV lamp may break. We recommend you to replace the UV lamp with a new one before it reaches its rated life.



- Be sure to use only the UV lamp recommended by Mimaki, or it may cause fire or damages to the unit. Never use UV lamps other than those recommended by Mimaki. We would take no responsibility for any troubles caused through the use of a UV lamp not recommended by Mimaki.



- Never look at the UV lamp being lit with your naked eyes, or it may cause pain in your eyes or visual impairment. Be sure to wear safety glasses.



- Do not apply ultraviolet (UV) light directly to your skin, or it may cause irritation on your skin.



- Do not touch the lamp on or right after the lamp off with bare hands to avoid from burn injury. Make sure to replace the lamp after it cools down completely.



- Before replacing, mounting or demounting a lamp, be sure to set the power OFF, or it may cause electrical shock.

Handling of the power cable



- Use the supplied power cable.



- Take care not to damage, break or work on the power cable. If a heavy matter is placed on the power cable, heated or drawn, the power cable can break to cause fire or electric shocks.

 **WARNING**

Handling the Anti-freezing liquid



- Be sure to wear goggles and gloves for handling the Anti-freezing liquid.



- Use the exclusive Anti-freezing liquid by Mimaki , or the heater may be damaged.



- If the Anti-freezing liquid or mixed soft water with anti-freezing liquid gets on the skin or clothes, immediately wash it off with soap.

If you get the Anti-freezing liquid or mixed soft water with anti-freezing liquid in your eyes, immediately wash your eyes with a lot of clean water. Then, consult a doctor as soon as possible.

If high temperature Anti-freezing liquid or mixed soft water with anti-freezing liquid gets on the skin, immediately wash it off with soap and cool with iced water.

Then, consult a doctor as soon as possible.



- If you swallowed the Anti-freezing liquid or mixed soft water with anti-freezing liquid accidentally, try to get to vomit, and then consult a doctor as soon as possible.



- Before using the Anti-freezing liquid, be sure to read the Material Safety Data Sheet (MSDS).





















- When unused the Anti-freezing liquid or used mixed soft water with anti-freezing liquid should discard as followings,
 - * Incinerating the fluid which is absorbed to the sawdust or waste cloth.
 - * Entrust them to an industrial waste disposal contractor, clarifying their contents.



- Avoid ignition such as static electricity and impact spark.

Precautions in use

 CAUTION	
<p>Periodic exchange parts</p> <ul style="list-style-type: none">  There are some parts which must be replaced by service men. You have to make a contract with distributors or dealers for after-sale service. 	<p>Warning labels</p> <ul style="list-style-type: none">  This device is adhered with a warning label. Be sure understand firmly the warnings given on the labels. In the case where any of the warning label has become so soiled that the warning message is illegible or has come off, purchase a new one from your local distributor or our office. Refer to Appendix for the label
<p>Protection against dust</p> <ul style="list-style-type: none">  It is strongly recommended to use the device in a room that is not dusty. Set the Refresh level 2 or 3 when in bad environment.  When leaving the workshop after the working hours, be sure to take off any media from the roll hanger. If any media is left on the roll hanger, dust can put on it.  Store media in a bag. Wiping off dust accumulated on a media will adversely affect the media due to static electricity.  Frequently the capping station clean to eliminate dust and paper chips.  Dust in the head will also cause drops of ink to fall abruptly down on the media during printing. If this phenomenon takes place, be sure to clean up the head. 	<p>Ink cartridges</p> <ul style="list-style-type: none">  If the ink cartridge is moved from a cold place to a warm place, leave it in the room temperature for three hours or more before using it.  Open the ink cartridge just before installing it in the printer. If it is opened and left for an extended period of time, normal printing performance of the printer may not be ensured.  Make sure to store ink cartridges in a cold and dark place.  Be sure to thoroughly consume the ink in the ink cartridge after opened. If an extended period of time has passed away after opening the cartridge tank, printing quality would be poor.  You cannot use any other ink type than the exclusive one. If you use any other ink type, it may cause the damage for the device. To repair of the device is your responsibility as used instead the exclusive one.  Never refill the ink cartridge with ink.  Neither pound the ink cartridge nor shake it violently so as to prevent leakage of ink adhering locations.
<p>Cover</p> <ul style="list-style-type: none">  Never open the cover during printing. Opening the cover or lever will abort printing. 	
<p>Adjusting the level</p> <ul style="list-style-type: none">  The level must be adjusted before printing can start. 	
<p>Handling of maintenance liquid</p> <ul style="list-style-type: none">  Be sure to store the maintenance liquid in a cold and dark place.  Store the maintenance liquid in a place that is out of the reach of children. 	

CAUTION

Handling the Anti-freezing liquid



- Be sure to store the Anti-freezing liquid in a cold and dark place.
- Store the Anti-freezing liquid in a place that is out of the reach of children.

About UV light



- Some UV light leaks from the openings for carrying in/out media. UV light applied to your skin might cause inflammation and/or skin cancer. Though weak UV light might cause no inflammation, repeated exposure to it may lead to chronic disorders. Avoid applying UV light to your skin and eyes.



- Impairment of eyes caused by UV light may be:
Acute disorders ... Pain in eyes, tearing, etc.
Chronic disorders ... Cataract, etc.
When using this device, take protective measures such as gloves, long-sleeve cloth, light-resistant mask, attached light-resistant glasses, etc.

About cleaning



- After using the unit long time, foreign materials and dust may be gathered on the conductive and insulating parts, causing electric leakage. Periodically clean such parts.



- For cleaning, do not use compressed air because it scatters foreign materials and dust, which may cause malfunctions when put inside the conductive parts. Be sure to use vacuum cleaner for cleaning of foreign materials and dust.



- Do not use the unit in a place where there is a possibility of being wet, or electrical leakage may occur.



- Electrical leakage, if it should occur, may lead to electrical shock of personnel or fire.



- In order to prevent accidents from occurring, be sure to carry out periodic inspections and replacement of time-change components.

About hot parts



- The UV lamp and the interior of the UV irradiation device will have a very high temperature. When carrying out maintenance, wait until the temperature has been sufficiently lowered after the lamp is turned OFF.



- Some parts outside the unit will have a very high temperature. A high-temperature caution label is placed on such parts. Do not touch the parts with the caution label placed and their vicinity, or burn injury may occur.



- When it is unavoidable to touch hot parts, be sure to wear heat-insulating gloves to protect your hands.

About firing and smoking



- Touching hot parts such as the UV lamp with combustible materials may cause firing and/or smoking.



- After the unit is used long time, foreign materials or dust gathered on the stabilizer or other parts may cause electrical leakage or insulation deterioration may cause firing and/or smoking. Periodically clean the parts and measure the insulation resistance, replacing deteriorated parts, if any.



- After the unit is used long time, screws, etc. on the conductive parts may be loosened, causing firing and/or smoking. Periodically tighten such screws.





- Because this unit is not of explosion proof type, do not use it in an ambience with hazardous materials, or a possibility of explosion may arise.



- If abnormal conditions such as abnormal odor, smoking, traces of







 **CAUTION**

Notes on UV lamp

- 
 - The UV lamp performance and service life are significantly affected by the UV irradiation and UV power supply units used. Never use those UV devices other than those recommended by Mimaki. We would take no responsibility for any troubles caused through the use of a UV devices not recommended by Mimaki.
- 
 - When handling the UV lamp or the silica glass on the bottom of the irradiation device, be sure to wear the gloves attached and never touch them with bare hands, or the UV ink curing level is significantly lowered. If the UV lamp or silica glass is contaminated, wipe it with clean gauze moistened with alcohol. (Do not use alcohol for cleaning the exterior cover, or the paint will peel off.)
- 
 - Securely mount the UV lamp to the socket, or the lamp may be dropped or overheated.

Precautions in installation

 **CAUTION**

A place exposed to direct sunlight	A place that is not horizontal
 <ul style="list-style-type: none"> • Do not install the device at a place where the temperature of the cut panel surface exceeds 60°C (140°F). The cut panel can deform or break down. 	 <ul style="list-style-type: none"> • If the printer is not leveled, the printer will fail to give correct results. Also the tilted printer can break.
A place in which temperature and humidity vary by a great margin	A place that vibrates
 <ul style="list-style-type: none"> • Use the device under the following environment. Operating environment: 15 to 30°C (59 to 86°F) 35 to 65% (Rh) 	 <ul style="list-style-type: none"> • The device will fail to give correct results if installed in a place that vibrates.
A place exposed to direct air blow from air conditioner, etc.	A place where fire is present
 <ul style="list-style-type: none"> • Do not install the device to direct are blow from air conditioner, etc, or the ink may get spattered. 	 <ul style="list-style-type: none"> • The printer is a precision machine. Do not use it in a place that is filled with dirt and dust.

How to read this Operation Manual

Display on the LCD and Indication of the Keys

In this Operation Manual, the characters displayed on the LCD of the operation panel and the keys used to operate the device are explained, together with the operation procedure.

 P.1-18.

Operate the device while confirming the display on the LCD.

Display on the LCD

The content of display is shown in characters in a box as shown at right.

Operate the device according to the explanation of the operation procedure and the content of display on the LCD.

In this Operation Manual, each setting and messages displayed on the LCD is enclosed in [], like [TYPE.1], [PLEASE WAIT], etc.

FUNCTION	
SET UP	< ENT >

SET UP	
SELECT	: TYPE.1

Operation keys

In the text of this Operation Manual, the operation keys are shown enclosed in brackets.

[▲] and [▼] indicate Jog keys.

The other operation keys are enclosed in brackets, as [FUNCTION].

Structure of this Operation Manual

This Manual consists of the following seven chapters to describe the handling of the device.

Chapter 1 Before use

This chapter describes the name and function of each section of the device.

Chapter 2 Operations

This chapter describes a series of operations and settings, ranging from power-on to end of printing.

Chapter 3 Daily care

This chapter describes the recovery procedure for ink clogging and the cleaning procedure for each section.

Chapter 4 Setting function

This chapter describes the setting function.

Chapter 5 Maintenance functions

Describes about maintenance including procedures for solving nozzle clogging, replacing the UV lamp, etc.

Chapter 6 When abnormal conditions are encountered

This chapter describes how to correct troubles after the occurrence of an abnormal condition on the device.

Appendix

This appendix describes the specifications of the device, function menu structure.

Chapter 1

Before use

This chapter describes the name and function of each section of the device as well as ink and media.

Table of contents

Installing the device.....	1-2
Configuration and function	1-4
Connecting the cables.....	1-10
UV unit and UV irradiation device	1-12
Installing the ink cartridges	1-15
Ink cartridge and ink station	1-16
Types of media that can be used	1-17
Menu mode	1-18

Installing the device

Where to install the device

Secure a suitable installation space before assembling the device.

The place of installation must have space required not only for the device itself but also for printing operation.

Width	Depth	Height	Gross weight
About 2250 mm	About 1570 mm	About 1370 mm	About 420 Kg

* UV unit is not included.

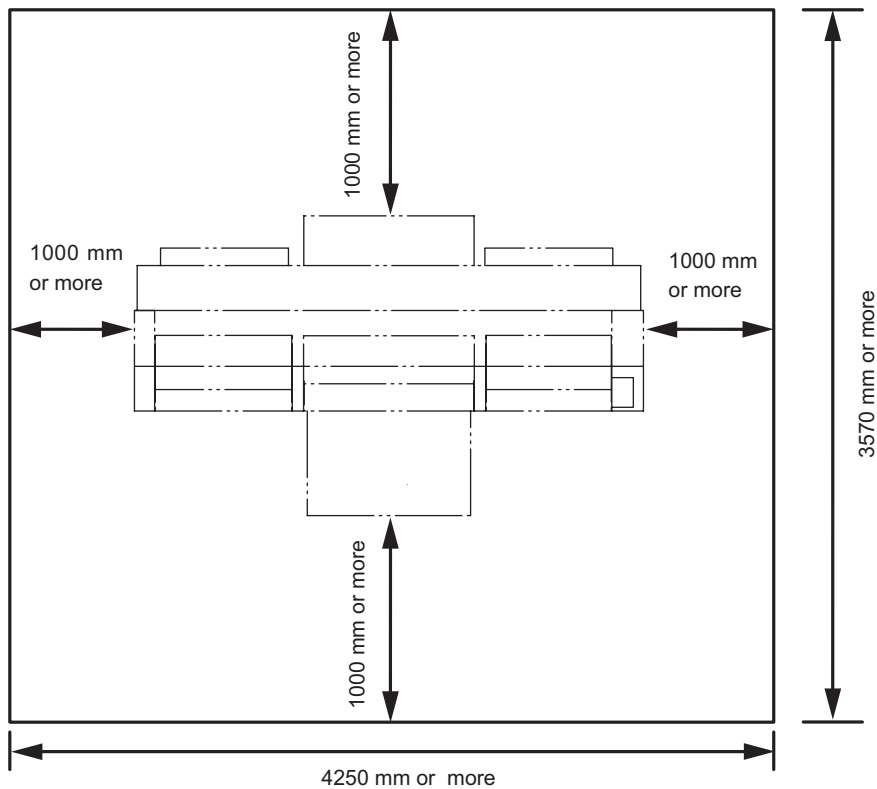

CAUTION

- This unit cannot be installed by the customer. Its installation should be entrusted to our service personnel or your electrical contractor.



- Be sure to carry out grounding work.



- In order to prevent electrical shock from occurring, carrying out electrical work by those unauthorized for that work is prohibited.

Method of moving the device

When moving the device, it must be held the corners up by at least four persons.

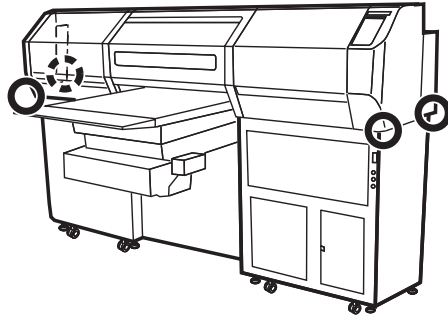

- When moving the device to a different place, contact local representative of Mimaki Engineering. If you move it, failure of damage may occur. Be sure to request a specialist to move the device.
- Be sure to disconnect the power cable and the interface cable before moving the device.



- Before moving the unit, wait until the UV lamp is cooled.
- When moving the device, take care not to apply excessive shock to it.
- Be sure to adjust the level feet to level the device at the new location.
- Do not hold the table or ink cartridge, or it may give damage to the unit.
- When moving the unit, carry it slowly and take care not to give shock to it.

Level feet

Before moving the device, sufficiently raise the level feet of the table frame. When installing the unit, lower the level feet.



- This unit has eight level feet. Lower them sequentially and slowly, taking care so that the gaps between the casters and the floor are nearly even.

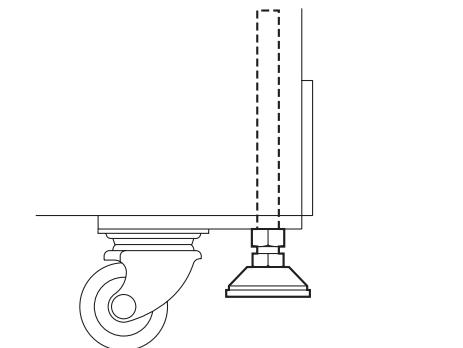

Configuration and function

The front

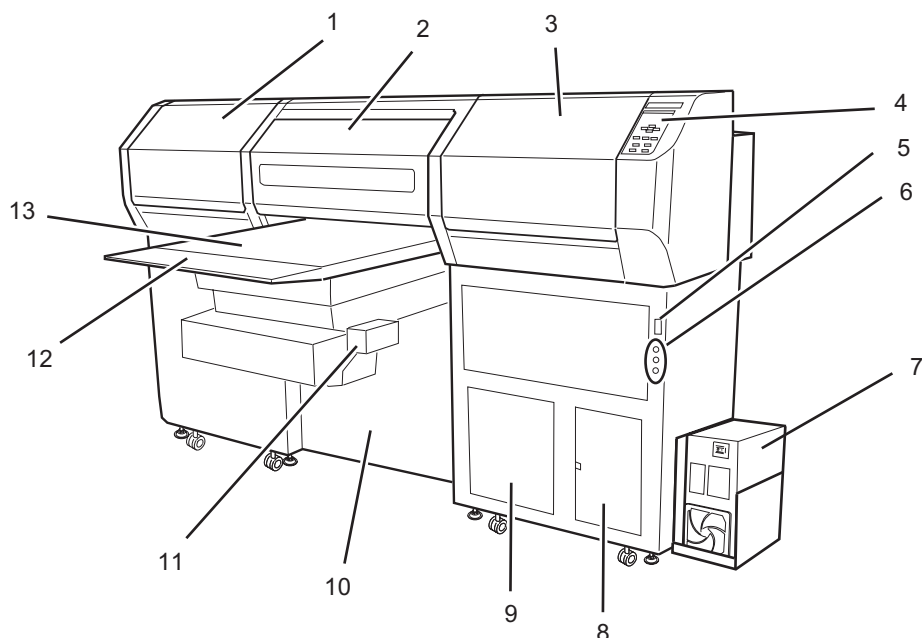

	Name	Function
1	Left maintenance cover	Position for standby during printing. Equipped with a flushing tray and opened and closed during maintenance.
2	Front cover	It is opened when setting media or taking a corrective measure against a media jam. Even if the power switch is off, keep the front cover closed to perform the ink clogging preventive operation.
3	Right maintenance cover	Equipped with a capping station and opened and closed during maintenance.
4	Operation panel	This panel has the operation keys required for operating the device and the LCD for displaying set items, etc.
5	Power switch	It turns on/off the power to the device.
6	UV lamp status indicator	Indicates the UV lamp status. (☞ P.1-13) Error (red)/UV lamp OFF, then cooling (orange)/enabled (green)
7	UV unit	Supplies power for the UV lamp.
8	Waste ink tank	Waste ink gathers in this tank.
9	Water heater	Keeps ink at appropriate temperature. (☞ P.3-8)
10	Blower unit	This allows a media to be pneumatically picked on the praten.
11	Sub-panel	Provides functions for moving the table up/down, turning the blower ON/OFF and copying.
12	UV light-resistant panel	Blocks light leaked from the UV lamp.
13	Table	Moves back and forth when performing printing.

The rear

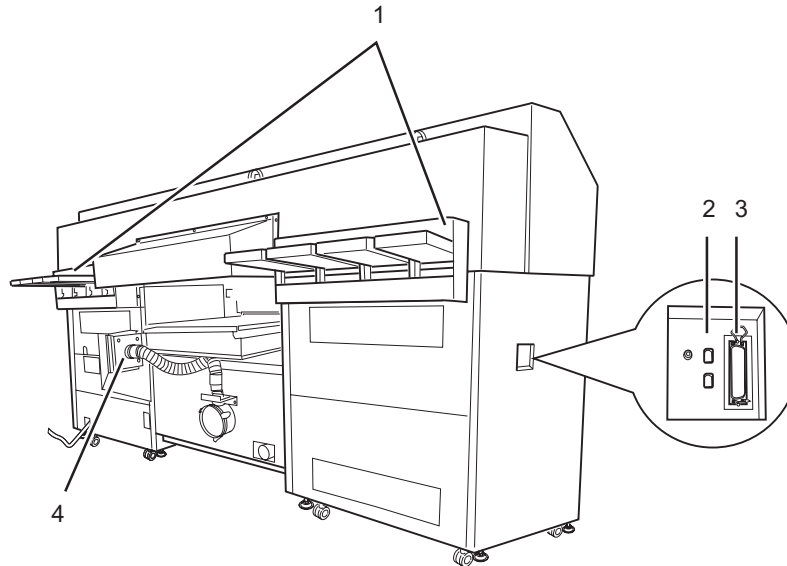

	Name	Function
1	Ink station	Install the ink cartridges specified.
2	IEEE1394 connector	A 400 M bps interface connector compatible with -IEEE1394.
3	Parallel connector	Bidirectional parallel interface connector. (complies with IEEE1284)
4	Air filter	Clean an air for the blower table.

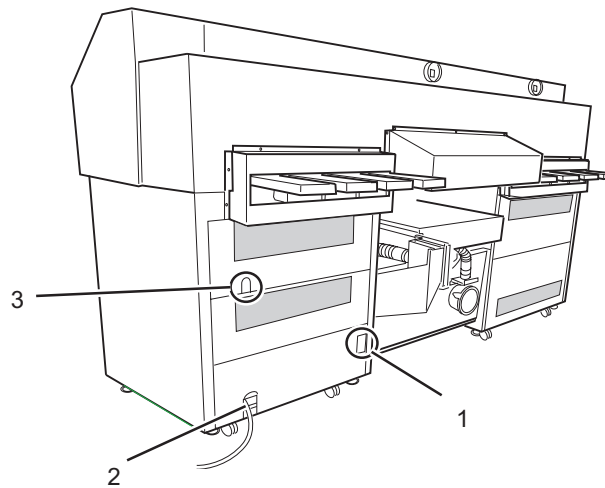

	Name	Function
1	D-SUB connector	Connects the UV lamp interface cable.
2	Main unit power cable	Supplies power for the main unit.
3	UV irradiation device connecting cable	Connects the irradiation device control cable and lamp cables to the UV unit.

Operation panel

The operation panel that is used to operate the device.

JOG keys [▲] [▼] [◀] [▶]

They are used to shift the carriage and the media under the LOCAL mode. In addition they are used to select a set value.

[TEST] key

Prints the test pattern for checking Nozzle clogging.

[FUNCTION] key

Enter to the setting function menu.

[END] key

Used to cancel the last set item that has been input or to return to the previous setting menu.

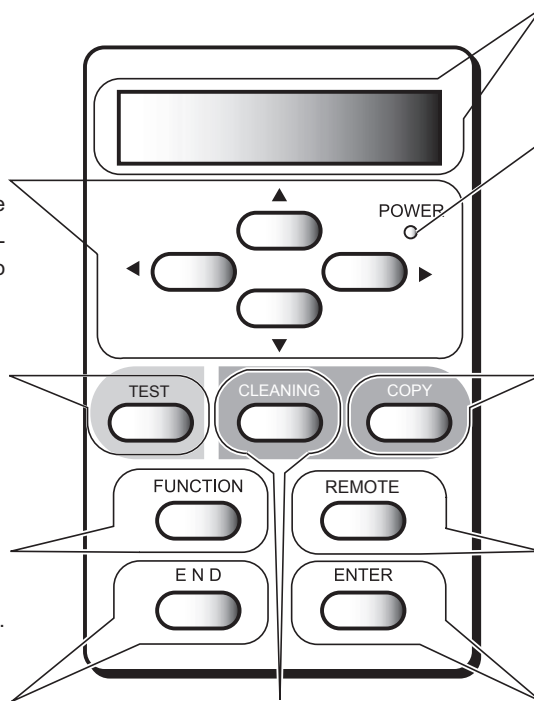

Display

Displays a set item, a guidance error, etc.

POWER lamp

It lights up (in green) when the power to the device is turned on.

[COPY] key

Repeats printing of already printed data. (☞ P.2-23)

[REMOTE] key

Change the operation mode between the REMOTE mode and the LOCAL mode.

[ENTER] key

Used to move to the lower-level menu and establish the settings.

[CLEANING] key

Performs head cleaning when ink clogging occurs.

Functions of the JOG keys

Each of the JOG keys varies in function according to the time at which it is used.

The functions of the JOG keys are explained below.

	When setting a printing origin / printing area	When selecting a function	When inputting a choice selected among several alternatives
◀	Shifts the carriage to the left.	_____	_____
▶	Shifts the carriage to the right.	_____	_____
▲	Shifts the work (table) away from you.	Restores the last previous function.	Selects the next value.
▼	Moves the work (table) toward you.	Moves to the next function.	Selects the last previous value.

Sub-panel

The sub-panel is used for moving the table up/down, copying and setting blower ON/OFF.

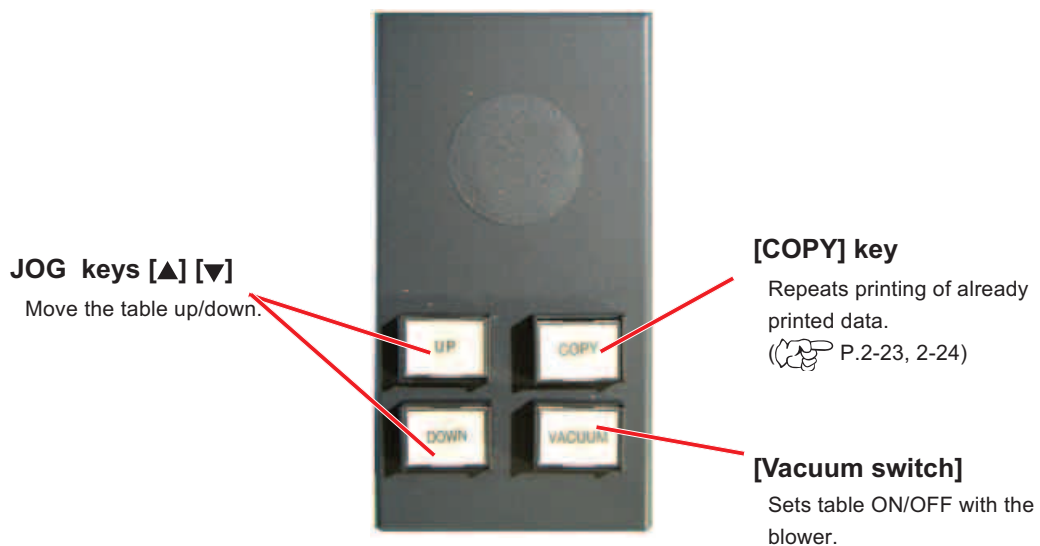

Carriage

The carriage contains the print head for printing and the UV irradiation device; there are a Mark sensor and light pointer inside the print head cover. Depending on UV lamp condition, the carriage is positioned differently.

The carriage sits in the left station cover during UV lamp ON.

The carriage sits in the right station cover during UV lamp OFF.



Capping station

The capping station on the front-right side of the unit consists of the ink caps and suction nozzle used for the maintenance of the print head. (☞ P.3-3)

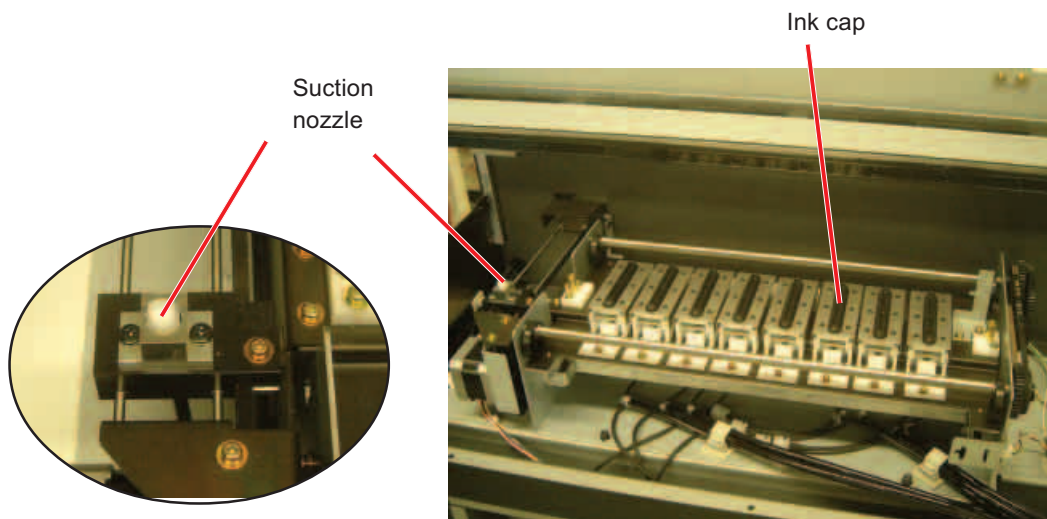

Flushing tray

Flushing tray is inside of the left maintenance cover at the front side.

When printing head executes flushing operation, waste ink may be collected in the flushing tray. Clean the waste ink from the tray regularly. (☞ P.3-5)

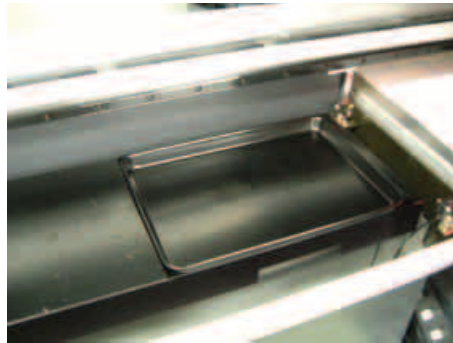

Connecting the cables

Connecting the interface cable

Connect the printer to the computer with the appropriate interface cable.

Two types of interface cables are available. Select the interface cable appropriate to the computer and output software.



- Turn off the power switch of the printer (the switch has to be tilted toward the “O” side) in prior to the connection of the interface cable and the power cable.

IEEE 1394 interface is used

Use an IEEE 1394 interface cable to connect the computer and the device together if the computer has IEEE1394 interface.



- The RIP used must be applicable to IEEE 1394.
- Either of the two IEEE 1394 connectors can be used.
- The computer is not provided with an IEEE 1394 board, contact your nearest RIP provider or MIMAKI sales office.

IEEE 1284 interface is used

Use an IEEE 1284 interface cable to connect the computer and the device together. It is possible to use an IEEE 1284 interface cable for connection between the computer and the device. In this case, however, the data transmission speed decreases.

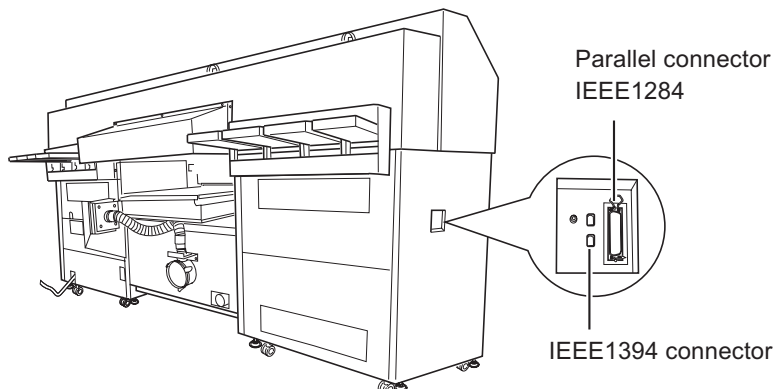

Connecting the power cable



- Connecting the power cable

For supplying power to the device, the power distribution board work are required.

Connecting the power cable cannot be installed by the customer.

Contact your local distributor to call for service to connect the power cable as well as moving installation of the device.

We should take no responsibility for any troubles caused through the power cable connection by the customer without calling for service.

UV unit and UV irradiation device

UV unit

The UV unit installed in the lower-right corner of this unit is interlocked with the UV irradiation device and UV indication lamps.



UV irradiation device



- Never look at the UV lamp being lit with your naked eyes.
- The UV lamp is hot and dangerous when it is being lit or immediately after it is set OFF. Do not touch such UV lamp.

In 2 minutes after setting the power to this unit ON, this device is enabled for irradiation.

The UV irradiation device is equipped with a shutter mechanism. The shutter opens automatically only when printing.

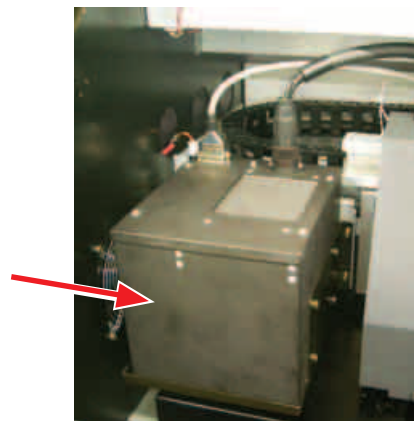

About functions of UV lamp status indicator





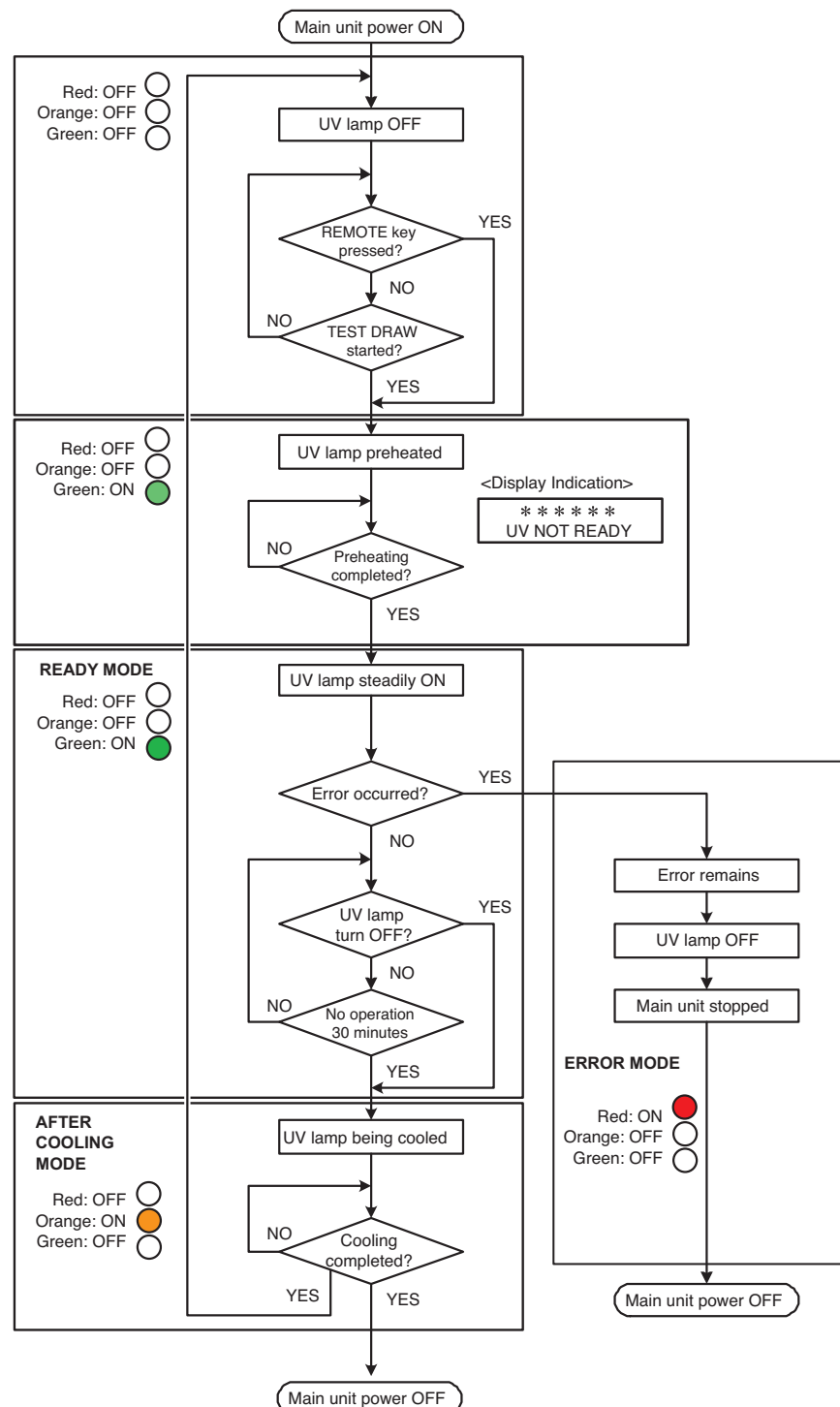

This section describes the functions of three UV lamp status indicator which placed under the power switch of this unit. The indicator represents three modes in combination. The UV lamp automatically goes OFF when printing is not carried out 30 minutes or more. When carrying out no printing long time (30 minutes or more), set the UV lamp OFF.

(☞ P.4-14)

Flowchart for the UV indicator





Mode for the UV lamp status indicator

Mode	Description of indicator lamps	Description
Ready mode		
ON/blinking (green) 	[Printing enabled] UV lamp being pre-heated (UV lamp preheating completed (ON) UV lamp steadily ON (Preheating time: 2 minutes and 30 seconds to 3 minutes)	When [REMOTE] or [TEST] key is pressed and [TESTDRAW] is selected, preheating of the UV lamp starts. When preheating is completed, the UV lamp is readied and printing starts.
OFF 	[Printing disabled] UV lamp OFF or other two modes	The UV lamp is not ready
After Cooling mode		
ON (orange) 	[Printing disabled] UV lamp being cooled (6 minutes)	The UV lamp goes OFF in the following cases: <ul style="list-style-type: none"> • When operation for setting the UV lamp OFF is carried out • When 30 minutes or more have elapsed after printing • When an error has occurred in this unit After the UV lamp has been set OFF, it is cooled. The UV lamp cannot be set ON again and this unit cannot start printing. Please wait for going the light off once.
OFF 	Other 2 modes	
Error mode		
	[Printing disabled] Error occurred (The UV lamp goes OFF.)	ON (red) <ol style="list-style-type: none"> 1. Error in UV power 2. UV lamp overheated The UV lamp goes OFF, the lamp cooling fan stops and printing with this unit also stops. 3. When the UV irradiation unit shutter does not function normally.
OFF 	Normal	

Installing the ink cartridges

Install the ink cartridges to the device.

 **CAUTION**

- When installing an ink cartridge, hold it laterally with the side containing the IC chip upward.
- After setting the main unit power ON, be sure to carry out initial filling.
( P.2-6)

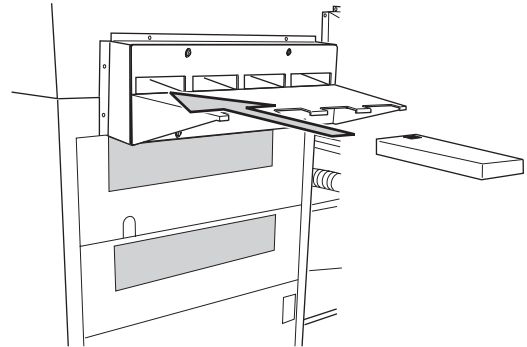

Each color is displayed on the LCD as follows:

Black : K, Cyan : C, Magenta : M, Yellow : Y,
Light cyan : c, Light magenta : m, White : W, Spot color : S

Relationships between ink station and head row

One color ink is applied to a nozzle.

Remember these relationships when checking the heads for clogged nozzles, replacing ink cartridge and replenishing inks.

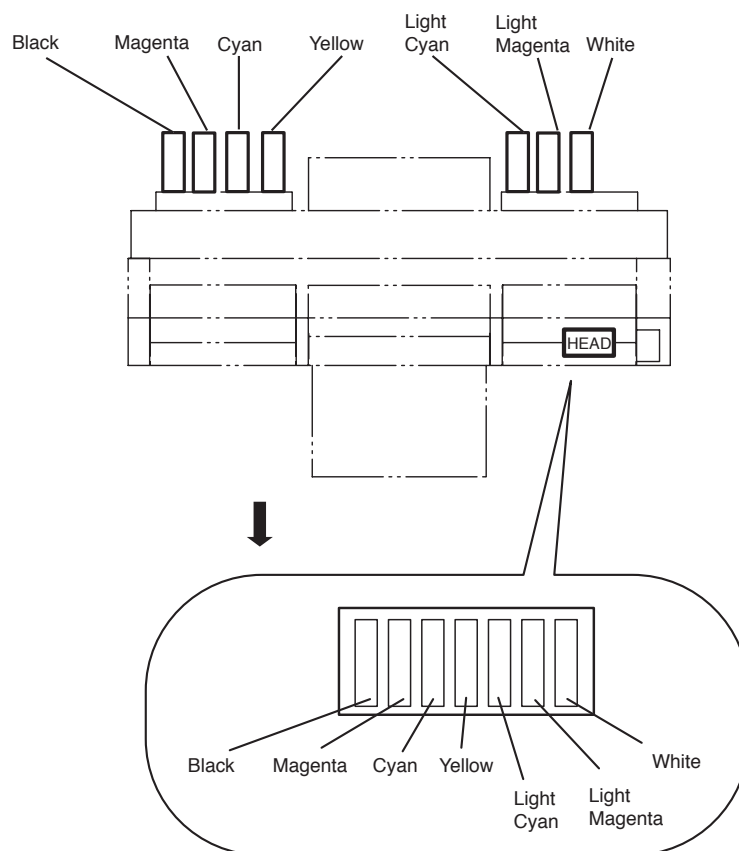

Ink cartridge and ink station

Precautions in handling the ink cartridge



- Use the recommended ink cartridge by Mimaki.
- If ink settles on the skin or clothes, immediately wash it off with soap and water. If you get ink in your eyes, immediately wash your eyes with a lot of clean water. Then, consult a doctor as soon as possible.
- If the ink cartridge is moved from a cold place to a warm place, leave it in the room temperature for three hours or more before using it.
- Be sure to thoroughly consume the ink in the ink cartridge, once it is opened, within six months. If an extended period of time has passed after opening the cartridge tank, printing quality would be poor.
- Store ink cartridges in a place that is out of the reach of children.
- When discarding unused ink cartridges, entrust them to an industrial waste disposal contractor, clarifying their contents.
- Some component (photoinitiator) of the ink is toxic against aquatic organisms. Avoid leakage of it to natural water system or domestic wastewater.
- Do not use ink cartridges expired the date noted on them.
- Before using an ink cartridge, be sure to read the Material Safety Data Sheet (MSDS).



- Do not shake the ink cartridge violently. Shaking or turning it roughly can cause leakage of ink.
- Never disassemble the ink cartridge.
- Never refill the ink cartridge with ink. Refilling the ink cartridge can cause a trouble. Remember that Mimaki assumes no responsibility for any damage caused by the use of the ink cartridge replenished with ink.
- Be sure to store ink cartridges in a cold and dark place.

Regular maintenance for white ink

White ink is easier precipitate than other inks, so that it may cause precipitate in ink cartridge. Make sure to perform regular maintenance to keep good ink condition when not in use the device for long term. Refer to Chapter 3.



- Use the specified ink.
- Regular maintenance must be done once in a week to avoid having white ink precipitate. Refer to Chapter 3.

Types of media that can be used

The following describes the sizes of media that can be used and the method of handling.

Sizes of media that can be used

Maximum	700 mm
Minimum	600 mm
Max. printing width	600 mm
Max. printing length	500 mm
Thickness	50 mm or less
Weight	5kg or less

Precautions in handling the media

Carefully observe the following when handling the media.



- Expansion and contraction of the media

Do not use sheet types of media immediately after unpacking.

The media can expand and contract due to room temperature and humidity.

The media have to be left in the atmosphere in which they are to be used for 30 minutes or more after unpacked.



- Curling of media

Tabular media should be flat or curled downward (swelled at the center) with the printing surface facing up. Media curled upward may not be absorbed to the table.

When storing media that is easily curled, place them on a base or pallet slightly smaller than the media area so that the media will be curled downward during storage.



- When using the table

In order to maintain the absorption effect, block the absorption holes on the table, which cannot be covered with media, with other media thinner than those to be used. ( P.2-7)



- Other notices

* Do not put anything on coated paper, or discoloration may occur.

* This unit is of the movable-table type. Curled media not wholly absorbed or those that will go out of alignment during table movement cannot be used. They may be made available when they are fixed on the table with adhesive tape, etc.

Menu mode

There are the following three mode in this device.
Each of the three modes is explained below.

< LOCAL > mode

This is the mode in preparatory state.

All keys are effective to enable setups.

The device is able to receive data from computer, however, it will not perform printing.

In this mode, it is possible to perform the following operations.

1. Pressing the appropriate JOG keys to set up an origin and the printing area.
2. Pressing the [TEST] key to start test printing.
3. Pressing the [CLEANING] key to start cleaning the print head.
4. Pressing the [COPY] key to copy the printing data the device has received.
5. Pressing the [FUNCTION] key to set printing conditions.

< FUNCTION > mode

While the device is in the LOCAL mode, press the [FUNCTION] key to put the device into the FUNCTION mode. This is the mode in which printing conditions can be set. Refer to the chapter 4 "Setting Function" or chapter 5 "Maintenance".

< REMOTE > mode

The device prints an image from data it receives.

During the printing operation, press the [REMOTE] key to interrupt the printing operation.

While the device is in the LOCAL mode, press the [REMOTE] key to put the device into REMOTE mode.

< MEM. > mode

A Printing information (pass number, resolution, color etc.) can be memorized for copying of multi editions, printing the data which was received.

While the device is in the REMOTE mode, press the [COPY] key to put the device into the MEMORY mode.

Chapter 2

Basic operations

This chapter describes a series of operations and settings, ranging from power-on to end of printing.

Table of contents

Operation	2-2
Turning the power on	2-3
Opening / closing covers	2-5
Initial setting of inks	2-6
Setting the media	2-7
Establishing the origin and the print area	2-15
Checking and solving nozzle clogging	2-19
Printing an image from source data	2-21
To replenish ink, set a new ink cartridge in the ink station	2-27
Ink cartridge trouble	2-28
Turning the power off	2-29

Operation

The following shows a series of operations and settings, ranging from power-on to end of printing. For details on each item, refer to the reference page.

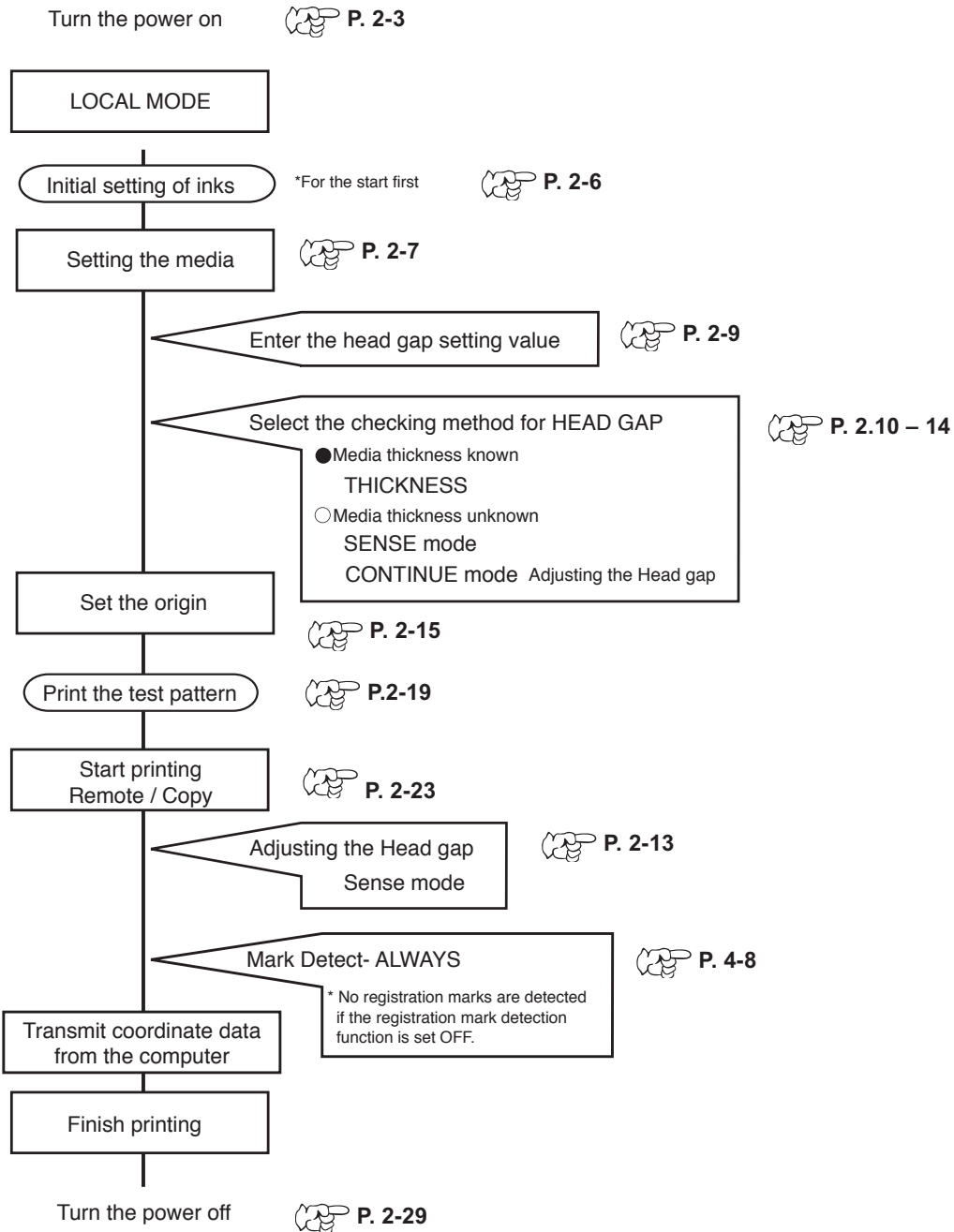

Turning the power on

1. Turn on the power of the UV unit.

Tilt the power switch toward the "I" side.



2. Turn on the power to the device.

Tilt the power switch toward the "I" side.

When the power is switched on, the LCD first displays "BOOT" and then displays the firmware version number.



3. The initial operation of the device is performed.



- To avoid injuries, keep your hands away from the device while in motion.
- If the UV device power is OFF, an error is indicated. Turn the UV device power ON and then turn the main unit power ON again.

ERROR 72
UV POWER OFF

- If the temperature in the water heater has not reached the predetermined value, an message is indicated. In this case, printing is disabled. It is enabled when the error indication has disappeared.

<<LOCAL>>
WATER NOT READY

BOOT



Ver *.*.*

4. The device enters the LOCAL mode.

5. Turn on the power to the computer which is connected to the device.

<< LOCAL >>

Displaying the information

Display the device informations by pressing [ENTER] key. The following explains the procedure for displaying information in local mode.



- Even in the REMOTE mode, you can display information by pressing the [ENTER] key.

1. Make sure that the Local mode is displayed.

<< LOCAL >>

2. Press the [ENTER] key, and display the Ink remaining.

ENTER REMAIN KCMYcmW
:12345678

3. Press the [ENTER] key, and display the firm ware version, used command version.

ENTER V1.50 / MRL-2B



- Refer to “Information” in the [Maintenance] item for the device information.
(P.5-29)

4. Press the [ENTER] key, and display the present UV lamp irradiation duration.

ENTER UV USED TIME
600 h 00m



- Refer to “Replacing UV lamp” in the [Maintenance] item for displaying UV lamp irradiation duration.
(P.5-16)

5. Press the [END] key, the menu returns to the LOCAL mode.

END << LOCAL >>

Opening / closing covers



- Keep all the covers closed during printing operation. Opening all the covers during printing interrupts image printing and disables continuous processing.
- make sure to open and close the cover with holding the handles. Doing so while holding the resin face may cause damage to the device.

When the cover is opened during printing, the carriage movement and printing operation stop for safety. In this case, restart this unit and computer in the procedures described below.

STEPS:

1. **When opening the cover during printing, the message shown on the right will be displayed.**

Stop the drawing.

! COVER OPEN
CLOSE A COVER

2. **Stop the data transmission from the computer.**

3. **Close the cover.**

4. **Press the [ENTER] key.**



(C O V E R O P E N)
PRESS < ENT > KEY

PLEASE WAIT

5. **The carriage will start to move.**

The carriage will carry out a series of performance same as that taken after turning on the power to the device (i.e., the predetermined initial performance).  page 2.3

Initial setting of inks

When using the device for the first time, it is necessary to install ink cartridges in the device. When replacing ink, see P.2-27.

STEPS:

1. Check that an ink cartridge has been inserted in the ink station up to the predetermined position and set.

2. Make sure that the LOCAL mode is displayed.

<<LOCAL>>

3. Press the [FUNCTION] key.

FUNCTION
 FUNCTION
 DATA CLEAR <ENT>

4. Select the [MAINTENANCE] by pressing the [▲] or [▼] keys.

▲

 FUNCTION
 MAINTENANCE <ENT>

5. Press the [ENTER] key.

ENTER

 MAINTENANCE
 LIST <ent>

6. Select the [FILL UP] by pressing the [▲] or [▼] keys.

▲

 MAINTENANCE
 FILL UP INK <ent>

7. Press the [ENTER] key.

ENTER

 FILL UP INK
 COLOR : KCMYcmW

8. Select the print head color by pressing the [◀] or [▶] keys.

◀

 FILL UP INK
 COLOR : KCMYcmW

9. Display the print head color must be filled by pressing the [▲] or [▼] keys.

▲

 FILL UP INK
 COLOR :K***c**

Put symbol [*] for colors to be filled with no ink.

10. Press the [ENTER] key.

ENTER

 FILL UP INK
 FILLUP INK START : ent

11. Press the [ENTER] key again.

The print head is automatically filled with ink.

ENTER

 INK FILL UP

12. Once the ink-filling procedure completes, the display shows as follow.

Press [END] key twice, the device enters the LOCAL mode.

MAINTENANCE
 FILL UP INK <ent>

Setting the media

All absorption holes on the table may not be blocked with media of a certain size. If necessary, block such absorption holes with a sheet such as paper, film, etc. thinner than the media used. If the media is likely to go out of alignment, affecting the printing, additionally fix the media with adhesive tape.

Types of media that can be used

Only media which meet the following conditions are available:

Size : 600mm x 500mm

Thickness : 50mm or less



- Only media with thickness of up to 50 mm are available. Use of media with thickness exceeding 50 mm will give damages to the cover.
- Adhesive tape, when used, must be of the kind that leaves no adhesive materials or tape itself on the table.
- Do not use curled media, or normal printing will be disabled.
- Do not use media larger than the table area.
- In case printing on a heavy media, do not put it on the front side. Put the media on the middle of the table to avoid a inclined table by the weight.
- Do not place hands on the UV light-resistant panel, or the table is inclined and it may stop printing.

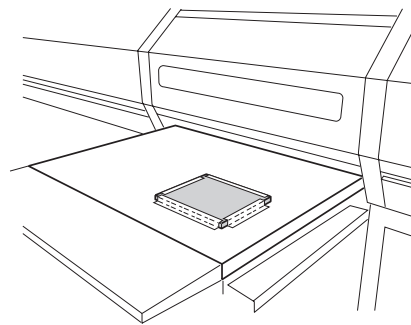
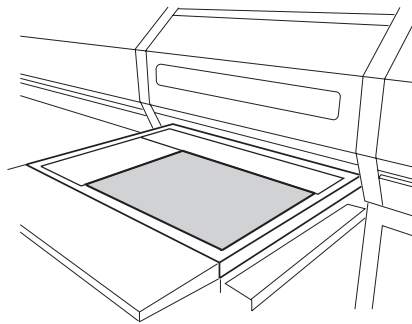

Front UV light-resistant curtain

When media of a certain height is set, light from the UV lamp may be leaked. To prevent leakage of light, attach the supplied front UV light-resistant curtains on the front cover. In this case, note that the lower end of the curtain should not touch the table surface.

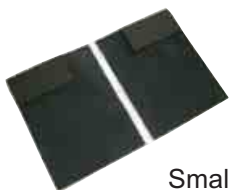

Small

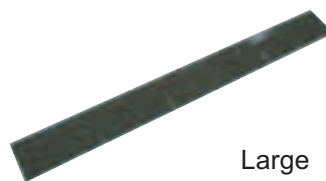

Large

Attaching the front UV light-resistant curtain

1. **Attach the large curtain to the handle part of the front cover.**

Attach it with the magnetic part up.

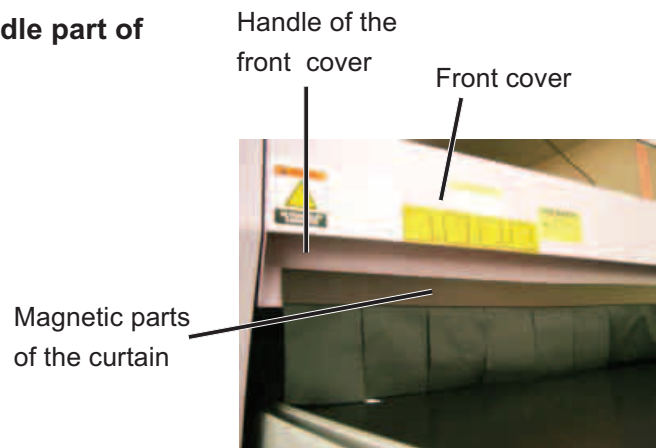

2. **Insert the curtain all the way until it hit a wall into the handle.**



3. **Attach the small curtains to the both cover ends.**

Make sure to attach them to prevent leakage of the UV light.



Completed attaching the curtains

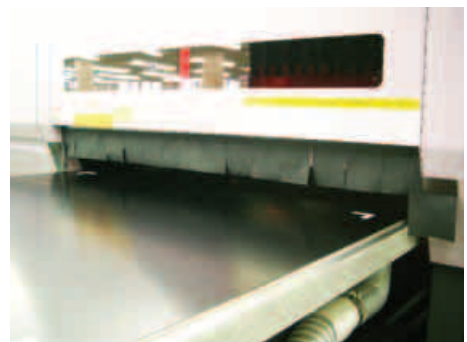

before setting media

We have three ways before setting media.

- Entering head gap value Enter and fix the head gap value.
- Media thickness known [Sense mode] or [Continue] mode.
Media thickness unknown [Media thickness] mode.
- Gap check Required when [Continue] mode is set.

Entering [Head Gap] value

The entered gap between the head and media is reflected to all media.

Enter a desired value. The registered type number is displayed. ( P.4-4)

Allowable set range: 0.9 to 2.0 mm (Initial value: 1.0 mm)

STEPS:

1. Make sure that the LOCAL mode is displayed.

<<LOCAL>>

2. Press the [FUNCTION] key.

FUNCTION
FUNCTION
DATA CLEAR <ENT>

3. Select the [HEADGAP *] by pressing the [▲] or [▼] keys

▲
FUNCTION
HEAD GAP 1 <ent>
▼

4. Press the [ENTER] key.
This is reflected to type 1.

ENTER
HEAD GAP 1 1.0mm

5. Enter the head gap value by pressing the [▲] or [▼] keys .

▲
HEAD GAP 1 1.5mm
▼

6. The device enters to the head gap.

ENTER
FUNCTION
HEAD GAP 1 <ent>

Selecting [GAP CHECK]- [SELECT] for head gap adjustment

Select the check method for gap adjustment during printing based on the head gap value entered. There are three check methods available. Select the check method to be used according to the media to be used.

When the thickness of media is unknown

Sense mode Select this mode when the thickness of media varies for printing operations. The head gap is adjusted for data and copy printing.

Continue mode Select this mode when continuously using media of the same thickness. Once the head gap is adjusted here, it is no longer adjusted for printing. Be sure to check the gap.

 P.2-13

STEPS:



1. Make sure that the LOCAL mode is displayed.

<<LOCAL>>

2. Press the [FUNCTION] key.

FUNCTION
 FUNCTION
 DATA CLEAR <ENT>

3. Select the [GAP CHECK] by pressing the [▲] or [▼] keys.



▲

 FUNCTION
 GAP CHECK <ENT>

4. Press the [ENTER] key.

ENTER

 GAP CHECK
 CHECK START <ENT>

5. Select the [SELECT] by pressing the [▲] or [▼] keys.

▲

 GAP CHECK
 SELECT <ent>

6. Press the [ENTER] key.

ENTER

 CHECK SELECT :CONTINUE

7. Select the [SENSE] mode or [CONTINUE] mode by pressing the [▲] or [▼] keys.

▲

 CHECK SELECT :SENSE

8. Press the [ENTER] key, then the device enters the [SELECT].

ENTER

 GAP CHECK
 SELECT <ent>

When the thickness of media is known

The allowable thickness range of media is 0 to 50 mm.

Media thickness When the thickness of media is known, enter the value. The head gap is not adjusted for printing.



- When changed the thickness of media, specify the exact thickness or the print head and UV irradiation device may be damaged.

STEPS:

1. Make sure that the LOCAL mode is displayed.

<<LOCAL>>

2. Press the [FUNCTION] key.

FUNCTION
 FUNCTION
 DATA CLEAR <ENT>

3. Select the [GAP CHECK] by pressing the [▲] or [▼] keys

▲
 FUNCTION
 GAP CHECK <ENT>
 ▼

4. Press the [ENTER] key.

ENTER
 GAP CHECK
 CHECK START <ENT>

5. Select the [SELECT] by pressing the [▲] or [▼] keys.

▲
 GAP CHECK
 SELECT <ent>
 ▼

6. Press the [ENTER] key.

ENTER
 CHECK SELECT
 :CONTINUE

7. Select the [THICKNESS] mode by pressing the [▲] or [▼] keys.

▲
 CHECK SELECT
 :THICKNESS
 ▼

8. Press the [ENTER] key to return to [SELECT].

ENTER
 GAP CHECK
 SELECT <ent>

9. Select the [THICKNESS] by pressing the [▲] or [▼] keys.

▲
 GAP CHECK
 THICKNESS <ent>
 ▼

10. Press the [ENTER] key.

ENTER
 MEDIA THICKNESS
 :20mm

11. Enter the thickness value of media by pressing the [▲] or [▼] keys and then press the [ENTER] key.



12. Press the [ENTER] key.

Table raise up unto the height of the media.
Adjust the table height that the highest part of the media is to be same as the head gap setting value.

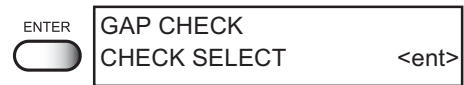

13. Press the [ENTER] key, then the device enters the GAP CHECK.

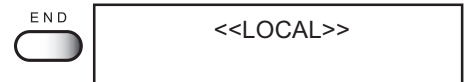

Checking head gap

When continue mode has been selected, be sure to check the gap. The table can be adjusted in height, according to thickness of a media used for printing. The table height must be set according to the media thickness. If the table height is too low, it may affect the printing quality and even damage the media or the device itself. Be sure that the table height is correct.



- When Continue mode has been selected
The head gap adjustment is performed once during printing after turning on the main power or initializing the data. Make sure to adjust the head gap for the gap check is not performed when the media thickness has been changed.

STEPS:

1. **Make sure that the LOCAL mode is displayed after setting media.**

<<LOCAL>>

2. **Press the [FUNCTION] key three times.**

FUNCTION

3 TIMES

FUNCTION
GAP CHECK <ENT>

3. **Press the [ENTER] key.**

ENTER

GAP CHECK
CHECK START <ent>

4. **Select [CHECK START], then press the [ENTER] key.**

When the table isn't at the lowest position, display the right message and move the table to the lowest position.

ENTER

** TABLE FALL **
PLEASE WAIT

5. **Set the media on the table.**

6. **After setting the media, press the [ENTER] key.**

Automatically starting the vacuum on when the vacuum switch is off.

ENTER

GAP CHECK
SET MEDIA :ent

7. **Press the [▲] key to move the table until the tail of media reaches the end of the front cover.**



GAP CHECK
MOVE TABLE :ent

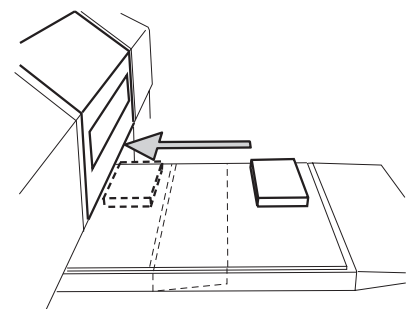

8. Press the [ENTER] key

The table moves upward and, at the same time, the head gap is automatically adjusted.



** TABLE FALL **
PLEASE WAIT

9. When adjustment has completed, [CHECK START] is restored.

GAP CHECK
CHECK START <ent>

10. Press the [END] key twice, the device enters the LOCAL mode.



<<LOCAL>>

Establishing the origin and the print area

Initial value

The origin and the print area are set as following by default until they are changed:

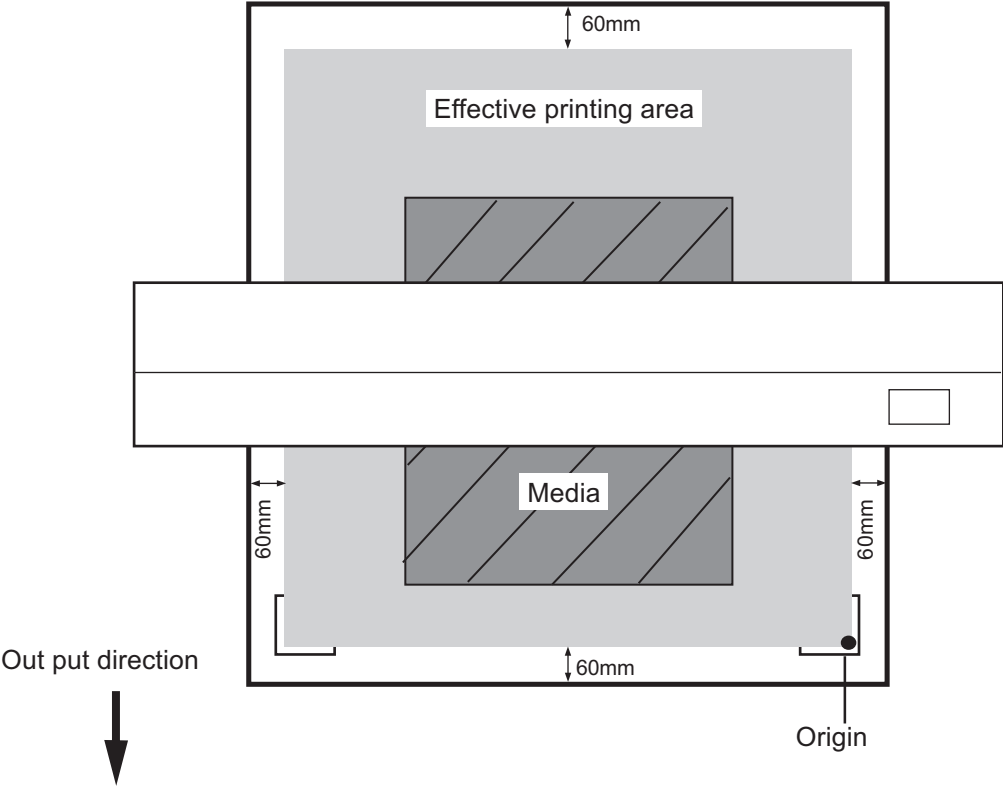

Setting printing origin

When printing in an area not initially set, change the printing origin.

The printing origin can be set in two ways:

- Setting printing origin using jog keys
- Setting printing origin using [ORIGIN] setting from the FUNCTION menu.

Setting printing origin using jog keys

STEPS:

1. **Make sure that the LOCAL mode is displayed.**
2. **Move the carriage to the position at which to establish an origin by pressing the [▲], [▼], [◀] and [▶] keys.**



- Red light pointer mark [●] is put on the table or media. This point becomes the origin of the coordinates displayed.

3. **After deciding the origin, press the [ENTER] key.**



- The new setting is saved until the origin or the print area is changed.
- To precisely set the origin, use [ORIGIN] setting from [FUNCTION] menu.
- Setting the origin by jog keys is cleared when turning the device off.

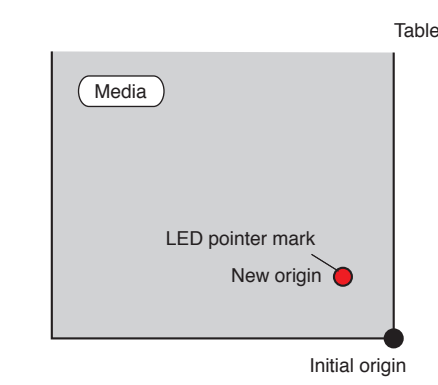
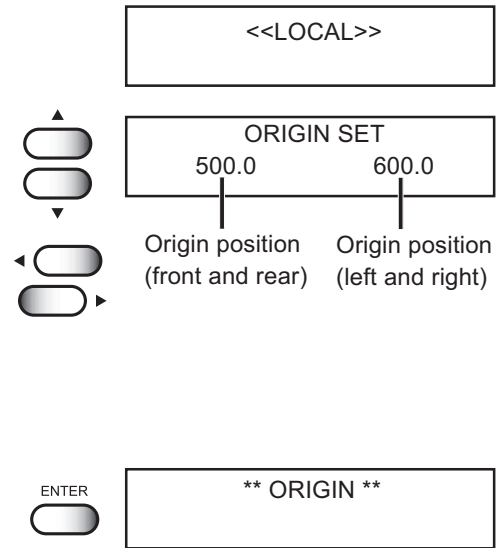

Setting origin position using jog keys

Setting precisely the origin ([FUNCTION] - [ORIGIN])

To precisely set the origin of coordinates, set its X- and Y- coordinates from the FUNCTION menu. This setting value become the origin position (0, 0).



- After setting the origin position (0, 0), it is not cleared even when the power is turned off. However if origin position was changed by Jog key operation, the setting value is cleared.

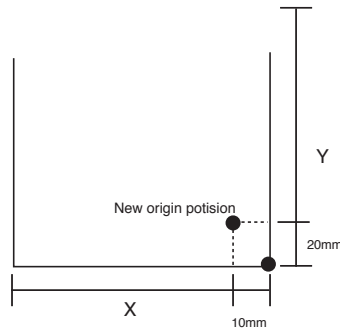

STEPS:

1. Make sure that the LOCAL mode is displayed.



2. Press the [FUNCTION] key.



3. Select [ORIGIN] by pressing the [▲] or [▼] keys.



4. Press the [ENTER] key.



5. Select [X OFFSET] by pressing the [ENTER] key.



Set the X origin.

6. Enter the setting value by pressing the [▲] or [▼] keys.



The number above the offset is indicated the distance from the origin to the maximum printing width.

7. Press the [ENTER] key, and set the X-origin.



Display enters the procedure 4.

8. **Select [Y OFFSET] by pressing the [▲] or [▼] keys.**

Set the Y origin.



9. **Press the [ENTER] key.**



10. **Enter the setting value by pressing the [▲] or [▼] keys.**



11. **Press the [ENTER] key, and set the Y-origin.**

Display enters the procedure 8. The origin of coordinates has been set.



12. **Press the [END] key three times, the device enters the LOCAL mode.**

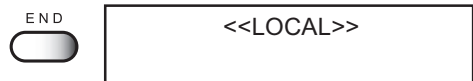

Checking and solving nozzle clogging

Make test printing to check whether there is nozzle clogging or other printing failures. If the finished test pattern shows any sign of abnormal conditions, carry out the cleaning function.

Normal pattern

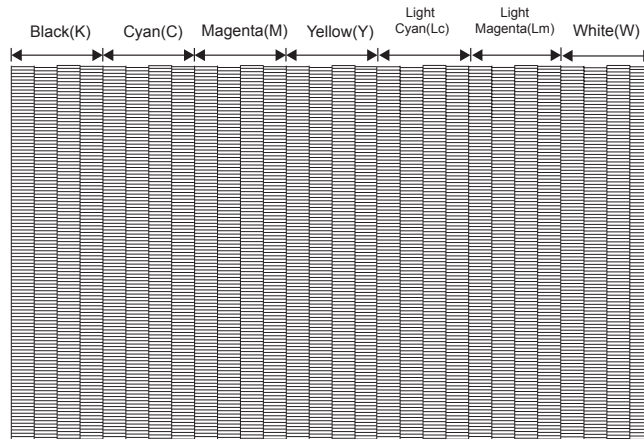

Print the test pattern



- If the temperature in the water heater or in the UV device has not reached the predetermined value, a message is indicated. In this case, printing is disabled. It is enabled when the error indication has disappeared.

UV NOT READY

WATER NOT READY

STEPS:

Make sure to set the media and the origin.

1. **Make sure that Local mode is displayed.**

<< LOCAL >>

2. **Press the [TEST] key.**

Gap check is performed when the head gap adjustment has not been checked. (P.2-13)



TEST DRAW
NOZZLE CHECK < ENT >

3. **Press the [ENTER] key.**

The device prints the test pattern.



** TEST DRAW **

4. **After the printing test pattern, the table moves towards, and then the device enters the LOCAL mode.**

<< LOCAL >>

5. **Check the test patterns.**

If a failure occurs, proceed with step next; otherwise, terminate the operation.

Abnormal pattern

If an abnormal pattern like the one shown on the right is printed, clean the head. There are two types of cleaning. Select one of them according to the result of pattern printing.

- Normal : Select this if any line is bent.
 Hard : Select this if not any recovering abnormal pattern.

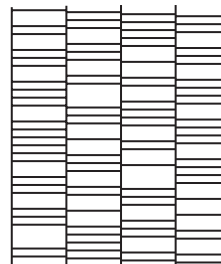

If the printing quality is not improved, clean the suction nozzle and cap. Refer to "Request for Daily Care of chap.3"

STEPS:

1. Press the [CLEANING] key.



CLEANING	
COLOR	:KCMYcmW

2. Select the print head to be cleaned by pressing the [◀] or [▶] keys.



CLEANING	
COLOR	:KCMYcmW

Select the head by color.

3. Display the print head for execution of cleaning by pressing the [▲] or [▼] keys.



CLEANING	
COLOR	:K**Y****

Select [*] for the heads not to be cleaned.

4. Press the [ENTER] key.



CLEANING	
TYPE	:NORMAL

5. Select the method of cleaning by pressing the [▲] or [▼] keys.



CLEANING	
TYPE	:HARD

6. Press the [ENTER] key.



CLEANING	
START	:ent

7. Press the [ENTER] key to execute the cleaning.



** CLEANING**
*****_-----

Cleaning is started.

8. After the cleaning, The device revert the LOCAL mode.

<< LOCAL >>

9. Origin has been setting automatically. Therefore repeat steps 2 and 3, and check the result of the test printing.

Repeat steps 2 to 8 until normal printing result is obtained.

Printing an image from source data

Starting the printing operation

The following describes the method of printing.

For various function settings necessary for printing, refer to “CHP5 Setting Function”.



- If the temperature in the water heater or in the UV device has not reached the predetermined value, a message is indicated. In this case, printing is disabled. It is enabled when the error indication has disappeared.

< REMOTE >
UV NOT READY

< REMOTE >
WATER NOT READY



- Data can be transmitted even when both errors are indicated. Printing starts after the indication has disappeared.

STEPS:

1. Make sure to set the media and turn the vacuum switch has been on.

2. The device enters the LOCAL mode.

3. Press the [REMOTE] key.



- Adjust the head gap when Sense mode has been set. See the description of gap check (☞ P.2-13).
- In other mode, gap check is performed as well with the latest mode and the head gap value in the case the head gap mode is changed or after turning on the main power.
- When registration mark detection has been set, the registration marks are detected in the same procedure as registration mark checking. For details, see Chapter 4. (☞ P.4-8). When registration mark detection is not necessary, press the [END] key. <REMOTE> screen is restored.
- When setting the [LAYER] by the UV level, indicate the number of layer at the right bottom of the remote display to confirm the intensity of the light level. Press the jog key [▲] or [▼] in this mode to change a layer and that allows the change of the UV level.

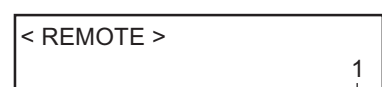
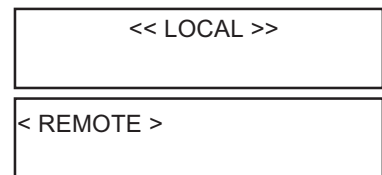

1
|
The number of layer
by the UV level



- When no registration marks are detected, an error is indicated and the local screen is restored.

When [ERROR35 MARK DETECT] is indicated, set [FUNCTION] menu - [MARK SETTING] again and then check the registration marks.

4. Transmit coordinate data from the computer.

The printing conditions that have been set for the data are displayed.

For the method of data transmission, see the manual for the output software.

5. During the printing.



- The origin remain unchanged after printing.
- When printing the same data repeatedly, use the copy function. (☞ P. 2-23)



- During printing, media may be heated by the UV lamp and raised, causing printing to be interrupted. In this case, set new media and restart printing.

6. After printing, turn the vacuum switch off, and then remove the media from the table.

ERROR 35
MARK DETECT

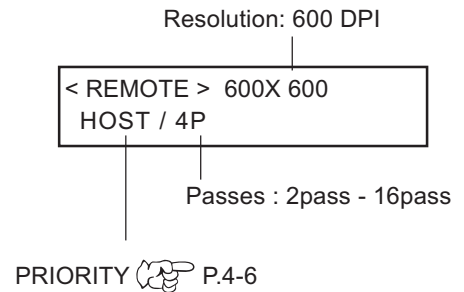

Printing repeatedly (COPY)

Data (1 edition) printed immediately before is printed again.

This operation can be carried out from the operation panel or sub-panel in the same way.



CAUTION

- If the temperature in the water heater or in the UV device has not reached the predetermined value, a message is indicated. In this case, printing is disabled. It is enabled when the error indication has disappeared.

< COPY >
UV NOT READY

< COPY >
WATER NOT READY

STEPS:

- After printing data, enter the LOCAL mode.**

Make sure to set the media and turn the vacuum switch on.

<<LOCAL>>

- Press the [COPY] key.**

The number of drawn copies is displayed.

The number of drawn copies



COPY
CNT: 1

<ENT>



CAUTION

- If there is no data drawn right before it, the message below is displayed and you cannot draw a copy.

COPY

NO DATA

- Press the [ENTER] key.**

Printing condition and the number of copies that is being drawn are displayed alternately.



- When using the sub-panel, pressing the ENTER key is not required.
- Adjust the head gap when Sense mode has been set. See the description of gap check (P.2-13).
- When registration mark detection has been set, the registration marks are detected in the same procedure as registration mark checking. For details, see Chapter 4. (P.4-8). When registration mark detection is not necessary, press the [END] key. <REMOTE> screen is restored.



< REMOTE > 600X 600
HOST / 4P

 Displays alternately.

< COPY >
CNT: 2

The number of copies that is being drawn

- The local mode is restored after printing has completed.**

Turn the vacuum switch OFF and remove media.

<<LOCAL>>

Interrupting the printing operation

To interrupt the printing operation, stop the carriage and erase (the receive data) from the device.

STEPS:

1. Press the [REMOTE] key to stop the printing operation.



2. If data is being transmitted from the computer to the device, stop the data transmission.

3. Press the [FUNCTION] key.
[DATA CLEAR] is displayed.

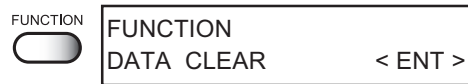

4. Press the [ENTER] key.
The data that has been received is erased, and the device enters the LOCAL mode.

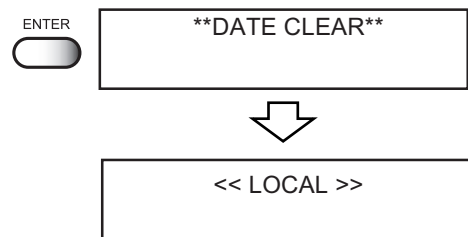

Printing multi editions repeatedly (multi editions copy)

Data printing at most 4 editions of multi editions can be printed and the procedure for data copying is following. Also pressing the [FUNCTION] key in COPY mode allows at most 4 editions, 4 times at most.

STEP

1. When the device is in the LOCAL mode, press the [REMOTE] key to put the device into the REMOTE mode.

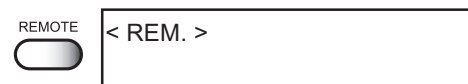

2. **During waiting for printing in the REMOTE mode, press the [COPY] key to put the device into the MEMORY mode.**

The MEMORY mode can print the receiving data as well as the REMOTE mode.

As the MEMORY mode can copy multi editions, printing information of each edition can be memorized.

3. **Some data (at most 4 times) sending from the computer can be printed.**

But when each edition has different resolution or there is the same color in another edition, multi editions copying can not be performed.

In this case, display the right error messages and complete the memory mode after printing.

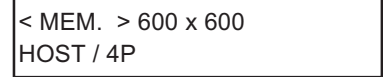
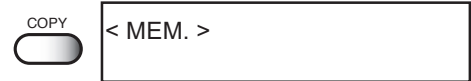

4. **After printing all editions data, press the [COPY] key and complete the MEMORY mode.**

Perform the change of the MEMORY mode before printing or after printing and do not change during printing.

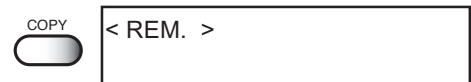

5. **Press the [REMOTE] key to put the device into the LOCAL mode.**

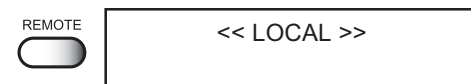

6. **Press the [COPY] key.**

The number of drawn copies is displayed.

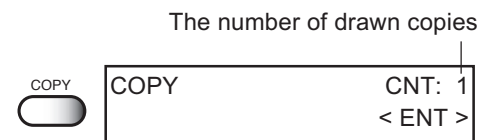

7. **When setting overprinting editions in turn and counting them, press the [FUNCTION] key.**

The copy edit mode is ready.

When not setting any overprinting editions in turn and counting, follow the procedure from STEP 10.



8. **Press the [◀] or [▶] key to select the printing order of the overprinting edition.**

The first one and second one from the left



9. Press the [▲] or [▼] key to select the over-printing edition.

The following display indicates the second edition two times after printing the first edition. [-] indicates no printing.

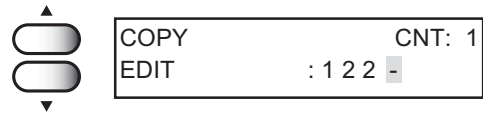

10. Press the [ENTER] key to execute copying.

Printing condition and the number of copies that is being drawn are displayed alternately.

When the right error message is displayed under the condition that multi editions copying can not be performed, errors are displayed and copying can not be performed.

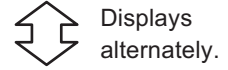
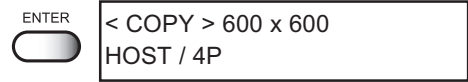
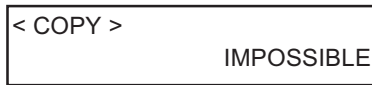

The number of copies that is being drawn

1 to 4: Version No. of copy that is being drawn
 _: Version of copy that has already been drawn
 *: Version of copy that will be drawn
 -: Not to be drawn

11. Data of each edition recorded is printed in order and the device reverts to the LOCAL mode.



12. In case of copying again, replace media and perform copying from the STEP 5.

Clear the number of copies

You can initialize the number of copies that you have drawn repeatedly to 0 (zero).

STEP

1. Make sure that Local mode is displayed.



2. Press the [COPY] key.



3. Press the [FUNCTION] key twice.

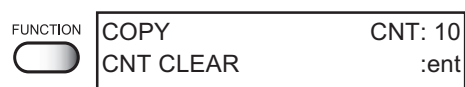

4. Press the [ENTER] key to clear the number of copies.

The device enters the LOCAL mode.



To replenish ink, set a new ink cartridge in the ink station

If ink in the cartridge comes to an empty, the corresponding message appears.
Printing can be continued but ink may run out during printing.
Immediately put a new ink cartridge.



- In case [NEAR END] is indicated on the LCD, replace a ink cartridge immediately.
- When installing an ink cartridge, hold it laterally with the side containing the IC chip upward.

< When the amount of ink becomes small during printing >

Indicate the ink color which has run out.
The display at right indicates that black ink comes to an end.

```
<<LOCAL>> NEAR END  
COLOR      :K
```

STEPS:

1. **Either of the messages shown above is displayed on the LCD during printing.**

```
<<LOCAL>> NEAR END  
COLOR      :K
```

2. **Install a new ink cartridge.**

Pull out the ink cartridge of the indicated color and then set a new ink cartridge.

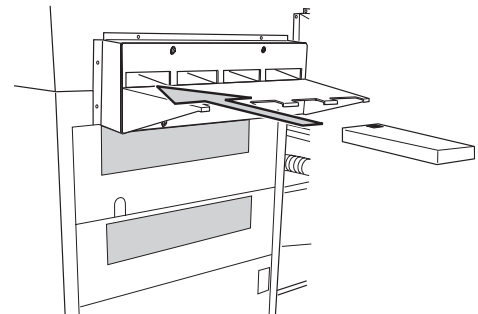

3. **Press the [REMOTE] key to execute the REMOTE mode.**

Continuous printing is available.



Ink cartridge trouble

When an ink cartridge trouble is detected, a warning message appears and printing, cleaning and all other activities that use ink are deactivated. When this is the case, replace the ink cartridge in question immediately.



- Do not leave the ink cartridge unreplaced for a long time as this will cause the nozzle clogging and the printer must be repaired by a service person.

Learning the detail of ink cartridge trouble

1. Display the trouble messages on the LCD.

The contents of cartridge error can be checked. For details, see "Troubles with Messages Displayed" in Chapter 6 "Troubleshooting."

```
! INK CARTRIDGE
COLOR           :KCMYcmW
```

2. Press the [ENTER] key while in LOCAL mode.



```
<< LOCAL >>
```

3. Press the [ENTER] key again.

The menu will return to the LOCAL mode automatically when no trouble exists.

If two or more cartridges have a problem, press the [ENTER] key again to display the second cartridge.

When all problem cartridges are displayed, the menu returns to the LOCAL mode automatically.



```
! WRONG INK IC
COLOR           :KCMYcmW
```

```
! NonORIGINAL INK
COLOR           :KCMYcmW
```

```
! Kind Of INK
COLOR           :KCMYcmW
```

```
! Color Of INK
COLOR           :KCMYcmW
```

```
! Expiration    : 2MON
COLOR           :KCMYcmW
```

```
! REINSERT CART.
COLOR           :KCMYcmW
```

Turning the power off

To turn the power off, check first whether or not there is data received and there remains data that has not yet been output in the device.



- Leave all the covers closed.
- Perform the operation for the turning off of UV irradiation device, and turn the device off when Orange Cooling lamp has been gone dark.

STEPS:

1. **Perform the operation for the turning off of UV irradiation device.**
2. **Make sure that the orange cooling lamp have been gone dark .**
3. **Turn off the power to the compute which is connected to the device.**
4. **Turn off the power to the device.**
Turn the power switch to the " O " side.



Chapter 3

Daily care

This chapter describes daily care.

For purchasing maintenance supply, contact your local distributor or dealer.

Swab (Order No. :SPC-0384)

Washing liquid (Order No. :SPC-0385)

Table of contents

Routine maintenance	3-2
In case defective printing is not resolved	3-3
Cleaning flushing tray	3-5
When the waste ink tank becomes full	3-7
Replacing waterin water heater tank	3-8
Regular maintenance for white ink	3-13
Cleaning or replacing filter	3-15
Cleaning the undersurface of the carriage	3-16

Routine maintenance

Be sure to conduct maintenance works for the device when necessary or periodically so as to use the device for a long time while keeping its printing accuracy.

When the device is left unused for a long period of time



- Be sure to turn off the power of device. (☞ P.2-29)



- Remove the media which setting on the table.

Notes on cleaning



- Never disassemble the device. Disassembling the device can result in electric shock hazards and breakage of the device.
- Prevent moisture from entering inside the device. If the inner part of the device becomes wet, electric shock hazards and breakage of the device can result.
- Conduct maintenance works after turning off the power switch and detaching the power cable. If not, unexpected troubles can arise.
- Make maintenance after the UV lamp has been sufficiently cooled, or burn injury may occur.
- Do not use benzine, thinner and chemical agents containing abrasives. Such materials can deteriorate or deform the surface of the cover.
- Do not apply lubricating oil or the like inside the device. Such materials can cause the printer mechanism to fail.

Maintenance for frame components

If the frame components of the device have stained, dampen a piece of soft cloth with water or neutral detergent diluted with water, squeeze it and wipe the frame components clean.

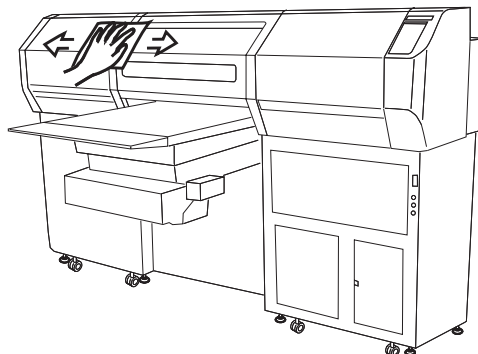

In case defective printing is not resolved

When the station interior is severely contaminated or defective printing is not resolved after executing the head cleaning function (☞ P.2-20), clean the suction nozzle and cap using the cleaning kit.

The cleaning kit contains the following contents. Do not use alcohol or water.

- Maintenance cleaning liquid
- Gloves, Cleaning swab, goggles



- When cleaning the ink station and head, be sure to wear the supplied goggle and gloves since you may get ink in your eyes.



- Do not move the carriage out of the capping station by hand. Use the appropriate operation key to move the carriage.

STEPS:

1. Press the [FUNCTION] key from the LOCAL mode.

<< LOCAL >>

2. Press the [▲] or [▼] keys until the display gives the indication [MAINTENANCE].

FUNCTION

FUNCTION
DATA CLEAR < ENT >

▲

FUNCTION
MAINTENANCE < ENT >

▼

3. Press the [ENTER] key.

ENTER

FUNCTION
LIST < ENT >

4. Press the [▲] or [▼] keys until the display gives the indication [STATION].

▲

MAINTENANCE
STATION < ent >

▼

5. Press the [ENTER] key.

ENTER

STATION
CARRIAGE OUT : ent

6. Press the [ENTER] key.
Move the carriage.

ENTER

7. Open the right maintenance cover.



8. Clean the suction nozzle using the exclusive cleaning swab which is containing maintenance cleaning liquid.



- Carefully clean the suction nozzle.



- Suction nozzle severely contaminated or bent should be replaced with a new one. Contact your nearest sales agency or Mimaki sales office.



- Contact your nearest sales agency or Mimaki sales office to order the exclusive cleaning swab.

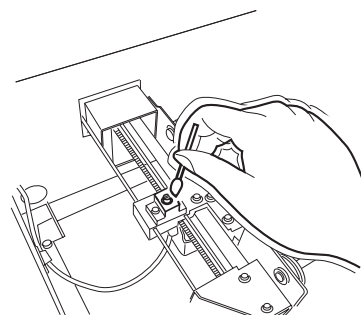

9. Wipe the adherent ink which got on the cap rubber or inside the suction nozzle cover with the exclusive cleaning swab.

Suction nozzle cover

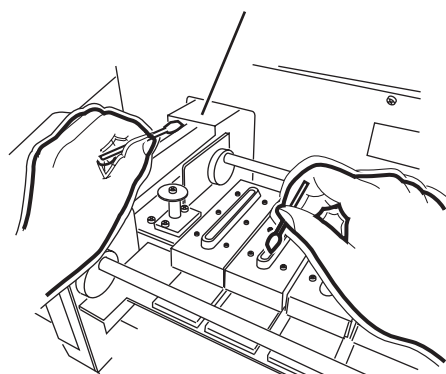

10. Close the maintenance cover and then press the [ENTER] key.

The carriage return to the capping station, and the initial operation is performed.



STATION
COMPLETED : ent

PLEASE WAIT

<< LOCAL >>

Cleaning flushing tray

Wipe off waste ink from the flushing tray.

Tools necessary for cleaning: Maintenance cleaning liquid, Gloves, Goggles, Paper towel



- When cleaning the ink station and head, be sure to wear the supplied goggle and gloves since you may get ink in your eyes.



CAUTION

- Do not move the carriage out of the capping station by hand. Use the appropriate operation key to move the carriage.
- Make sure to remove the waste ink in the flushing tray frequently. Otherwise the waste ink dried out solidly under the UV light and may not remove.

STEPS:

1. Press the [FUNCTION] key from the LOCAL mode.

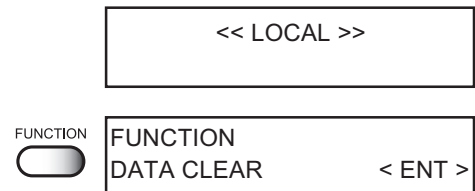

2. Press the [▲] or [▼] keys until the display gives the indication [MAINTENANCE].

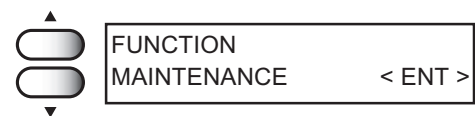

3. Press the [ENTER] key.



4. Press the [▲] or [▼] keys until the display gives the indication [STATION].

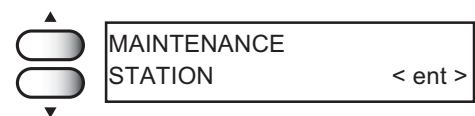

5. Press the [ENTER] key.

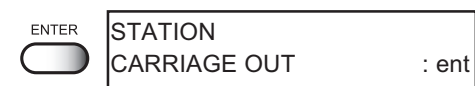

6. Press the [ENTER] key.
Move the carriage above the table.



7. Open the left maintenance cover.



8. Wipe off the waste ink from the flushing tray with the paper towel containing maintenance cleaning liquid. Take the caked ink off by patting the tray.



- Make sure to take the caked ink off completely, or it may cause head damage by the remaining caked ink. The UV ink dried out solidly under the UV light. In case unable to get rid of the caked ink, the tray should be replaced with a new one. Please contact your local dealer for purchasing a new tray.

9. Close the station cover and then press the **[ENTER]** key.

The carriage return to the capping station, and the initial operation is performed.



STATION
COMPLETED : ent

PLEASE WAIT

<< LOCAL >>

When the waste ink tank becomes full

Waste ink used for cleaning the heads will gather in the waste ink tank.



- Contact your local MIMAKI distributor or call a local MIMAKI office if you need a spare waste ink tank.
- Prepare a polyethylene tank for emptying waste ink.



- If ink is dripping, wait until it stops dripping.

When the tank is filled with waste ink, the following error message is indicated:

! INK TANK
WASTE TANK FULL

STEPS:

1. **Open the waste ink tank box cover.**
2. **Pull out the waste ink tank while pressing it downward.**



CAUTION

- When pulling out the waste ink tank, hold the opening of the waste ink tank with paper and then slowly pull it out to prevent waste ink from spattering.
- Before replacing ink, put paper on the floor to prevent it from being stained with ink.



3. **Dispose waste ink into a separate polyethylene tank.**



- Discard the waste ink according to the local regulations of the area this unit is used.



4. **Put the empty waste ink tank back into the device.**

Close the Waste ink box cover.



CAUTION

- To avoid hurt hands at the corner of the tank cover, be careful to set the tank.

5. **Press the [ENTER] key to complete the procedure.**

The device turn to the LOCAL mode.



WASTE TANK
TANK READY :ent

<< LOCAL >>

Replacing water in water heater tank

In order to keep the ink at an appropriate temperature, operate the water heater. Supply antifreezing liquid and water to the hot-water tank in the water heater.

Precautions for replacing or exchanging



- Water cannot be added.
- Be sure to use Soft water for replacing or exchanging.
- Soft Water and antifreezing liquid compound ratio should be 2 (Soft water) : 1 (Antifreezing liquid). When performing complement or replacement later, make a compound liquid in same proportion of 2 : 1.
- When only Soft Water is supplied to the hot-water tank without antifreezing liquid, it may damage the head.
- Check the water heater once a half year for the water level required and cleanliness inside the hot-water tank.
- If Soft Water in the hot-water tank frequently becomes insufficient, contact your nearest sales agency or Mimaki sales office.
- Discard the waste water mixed with Anti-freezing liquid according to the local regulations of the area this unit is used.



Precautions in handling the Anti-freezing liquid



- Be sure to wear goggles and gloves for handling the Anti-freezing liquid.



- Use the exclusive Anti-freezing liquid by Mimaki , or the heater may be damaged.
- If the Anti-freezing liquid gets on the skin or clothes, immediately wash it off with soap. If you gets the Anti-freezing liquid in your eyes, immediately wash your eyes with a lot of clean water. Then, consult a doctor as soon as possible.
- Be sure to store the Anti-freezing liquid in a cold and dark place.
- Store the Anti-freezing liquid in a place that is out of the reach of children.
- When unused the Anti-freezing liquid, entrust them to an industrial waste disposal contractor, clarifying their contents.
- Before using the Anti-freezing liquid, be sure to read the Material Safety Data Sheet (MSDS).



- When purchasing a hot-water tank for spare, contact your nearest sales agency or Mimaki sales office.
- Prepare a polyethylene tank for moving waste the water from hot-water tank.
- When water in the hot-water tank is insufficient, the error message shown below is indicated. In this case, replace water.

ERROR 70 WATER LACK

Replacing antifreezing liquid

1. Press the [FUNCTION] key from the LOCAL mode.

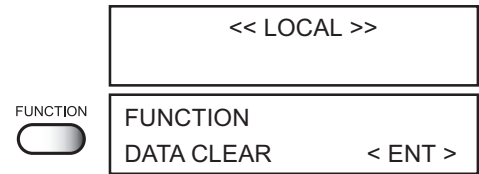

2. Press the [▲] or [▼] keys until the display gives the indication [MAINTENANCE].

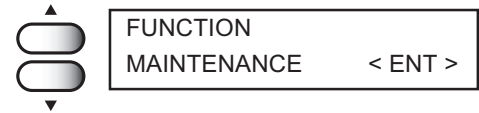

3. Press the [ENTER] key.



4. Press the [▲] or [▼] keys until the display gives the indication [WATER CHNGE].

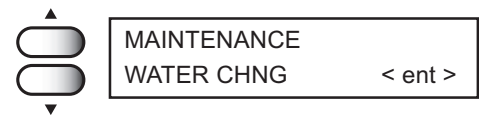

5. Press the [ENTER] key.



6. Start cooling down for the water heater after pressing the [ENTER] key.

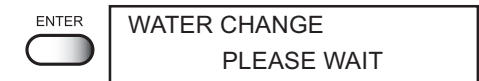



CAUTION

- Do not touch the water heater until [WASTE AF] is displayed to avoid from burn injury. In case using the device before the water heater replacement, it may take approx. 20minutes until [WASTE AF] is displayed.

7. Press the [ENTER] key when the [WASTE AF] is displayed.

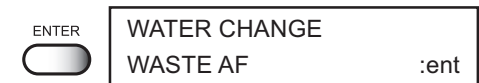

8. Open the water heater cover.

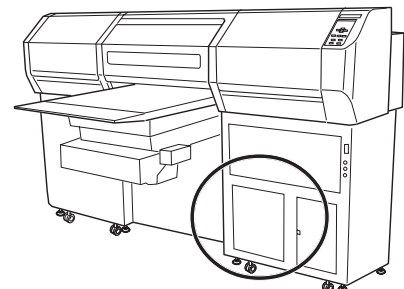

9. Unlock catch clips on both sides of the cover.

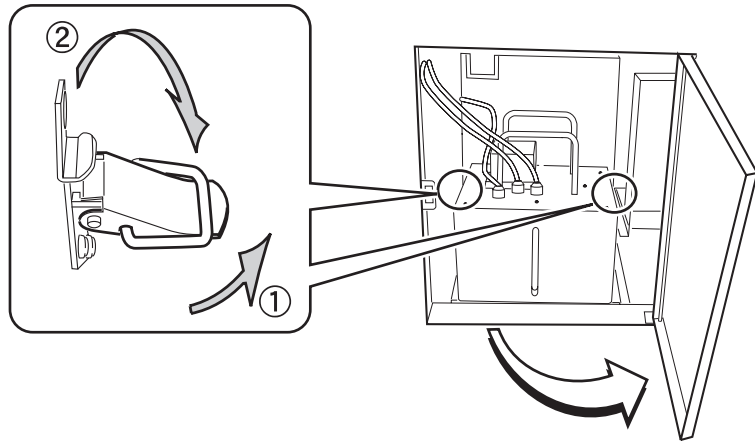

10. Engage the water heater handle with the hook.

**CAUTION**

- When engaging the handle with the hook, take care to avoid bending the cables or tubes or pulling them with excessive force, or it may cause malfunction of the water heater.

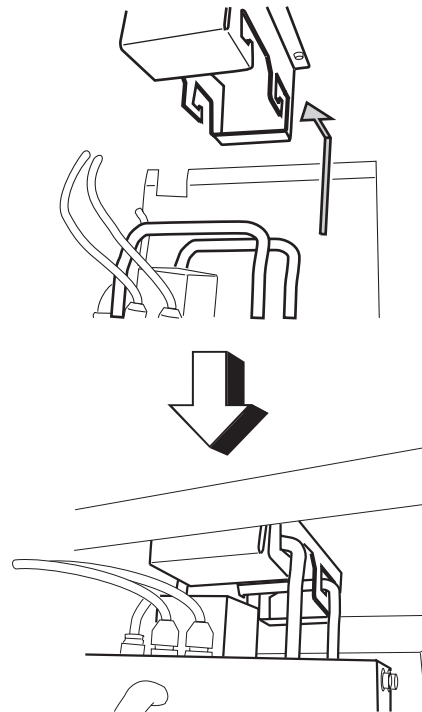

11. Remove the water heater tank.

**CAUTION**

- When moving water, take care not to spill it. If spilled, be sure to wipe it off.

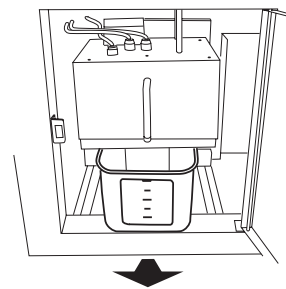

12. Move waste water in the hot-water tank to a polyethylene tank.

 CAUTION

- When moving water, take care not to spill it. If spilled, be sure to wipe it off.



- Discard the waste water from the hot-water tank according to the local regulations of the area this unit is used.

13. Set the empty hot-water tank into the water heater.

14. Lock the catch clips and close the cover.

15. Press the [ENTER] key.

Discharge of the antifreezing liquid in the device is started.

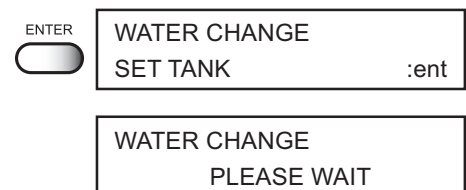

16. Press the [ENTER] key when the [WASTE AF] is displayed.



17. Open the water heater cover again and then remove the water heater tank.

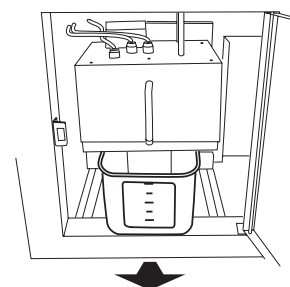

18. Again, move waste water in the hot-water tank to a polyethylene tank.



CAUTION

- When moving water, take care not to spill it. If spilled, be sure to wipe it off.



- Discard the waste water from the hot-water tank according to the local regulations of the area this unit is used.

19. Wash the hot-water tank.



CAUTION

- If neutral detergent is used for washing the tank, sufficiently rinse the tank with water.



20. Supply soft water and antifreezing liquid in the water heater tank.

Supply 500 cc of antifreezing liquid, followed by 1000 cc of soft water.



CAUTION

- The optimum volume of soft water is 1000 cc. Do not supply excessive water, or water leakage may occur when closing the water heater cover.

Ratio of soft water with antifreezing liquid

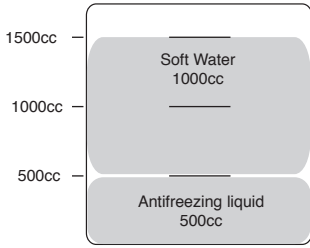

21. Return the hot-water tank to its original position, lock the catch clips and close the cover.

22. Press the [ENTER] key.

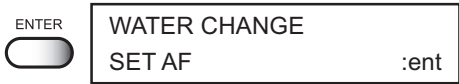

23. Press the [END] key and the replacement for the water heater was completed.

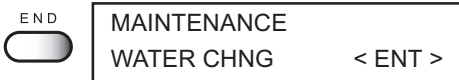

Regular maintenance for white ink

White ink is easier precipitate than other inks.

In case without printing more than two weeks, white ink may cause precipitate in ink cartridge or inside of the device. And nozzle clogging has occurred and the normal printing result is not able to obtain by precipitation. Make sure to perform regular maintenance to avoid precipitating and to keep good condition for white ink.



- Perform the maintenance below before working once a week.
- Regular maintenance must be done once in a week to avoid having white ink precipitate. Shake the ink cartridge up and down about 10 times slowly.

STEPS:

1. Press the [FUNCTION] key from the LOCAL mode.

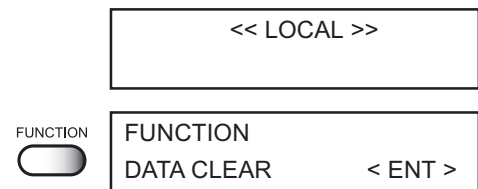

2. Select [MAINTENANCE] by pressing the [▲] or [▼] keys.

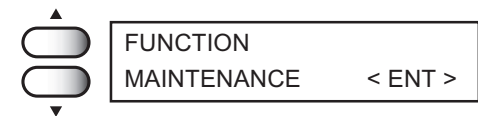

3. Press the [ENTER] key.



4. Select [WHITE MANT] by pressing the [▲] or [▼] keys.

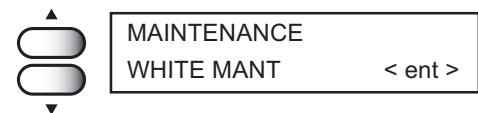

5. Press the [ENTER] key.



6. Remove White ink cartridge from the ink station.

7. Press the [ENTER] key.

Discharging of white ink is performed.



8. Slowly shake the white ink cartridge more than twenty times right and left.

To prevent ink from leaking when you shake the cartridge, wear gloves and firmly cover the A part of the upper surface of the cartridge and the B part of the bottom surface of the cartridge with paper towels. Then, shake it more than twenty times right and left so that ink flows inside the cartridge.



- If you shake it too strong, the pack inside may be damaged and it may cause ink leakage. Therefore, perform this carefully.
- If the remaining amount of ink is less, ink in the cartridge cannot be beaten enough. Tilt the cartridge until it becomes vertical.



A part (the place to stick a needle)

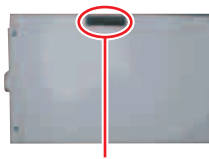

B part (the slot on the bottom)

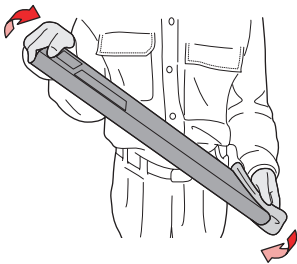

Repeat this

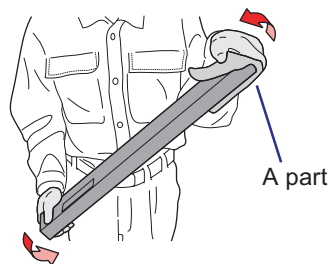

Cover with paper towel firmly and shake ink slowly

9. Put the ink cartridge back to the ink station.

10. Press the [ENTER] key and then start [FILL UP INK].

The FILL UP INK was completed.

ENTER	WHITE MAINT. SET CARTRIDGE
	INK FILL UP PLEASE WAIT
	MAINTENANCE WHITE MANT < ent >

Cleaning or replacing filter

This unit contains a filter for the table.

When the filter is clogged, the media absorbability will be weakened.

If filter is soiled with dusts, clean it with vacuum cleaner, etc.

If the filter is clogged by ink adhesion, replace the filter.

STEPS:

- 1. Turn the vacuum switch OFF.**

- 2. Remove the filter holder from the filter unit.**

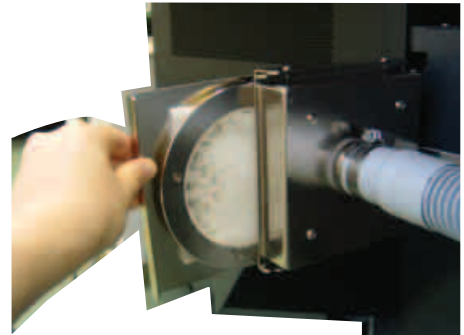

- 3. From the filter holder, remove the filter and replace with a new filter.**

Position the filter folded in four and fix it with its all circumference held.

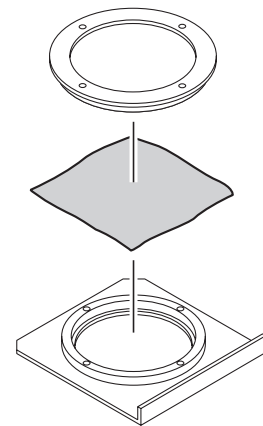

- 4. Install the filter holder on the filter unit.**

Return the filter holder to the filter unit.

Cleaning the undersurface of the carriage

Cleaning of the head guard plate

Ink drops may appear on the head guard plate on the undersurface of the carriage, result in inferior printing or ink blot on the media. Make sure to perform cleaning regularly the undersurface of the carriage.

For Cleaning: Cleaning swab, Maintenance cleaning fluid, glove, goggles



- Turn off the device before cleaning.
- To avoid burn injury, clean the undersurface of the carriage after the UV irradiation device cools down completely.

STEPS:

1. Make sure that the **LOCAL** mode is displayed.

<< LOCAL >>

2. Press [▼] key on the Sub panel to let the table down.

3. Press the [▲] key to move the table to the back side.

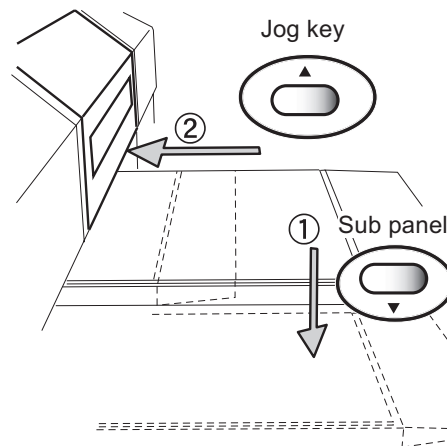

4. Press the [▶] key to move the carriage onto the table.

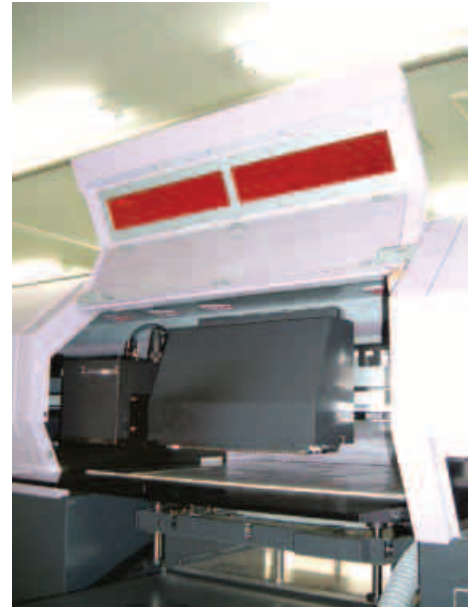

5. Turn the main unit power off.

6. Open the front cover.

7. Clean the undersurface of the carriage by the side surface of the exclusive cleaning swab which is containing maintenance cleaning liquid from under the table.



CAUTION

- Do not touch the head and nozzle part to avoid the damage.



- Contact your nearest sales agency or Mimaki sales office to order the exclusive cleaning swab.



8. After cleaning, close the front cover and then turn the main unit power on.

Cleaning of the nozzle side

Perform the following thing when ink drops by printing are generated on the nozzle side of the head or media is stained by dropping ink drops.

STEPS:

1. Press the [FUNCTION] key from the LOCAL mode.

<< LOCAL >>



FUNCTION
DATA CLEAR < ENT >

2. Select [MAINTENANCE] by pressing the [▲] or [▼] key.



FUNCTION
MAINTENANCE < ENT >

3. Press the [ENTER] key.



MAINTENANCE
LIST < ent >

4. Select [WIPE HEAD] by pressing the [▲] or [▼] key.

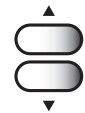

MAINTENANCE
WIPE HEAD < ent >

5. Press the [ENTER] key.



6. Select the head stuck ink drops by pressing the jog key [◀] or [▶] .



WIPE HEAD
COLOR : KCMYcmWS

7. Display ON / OFF of the wipe by pressing the jog key [▲] or [▼].
OFF is displayed as [-].

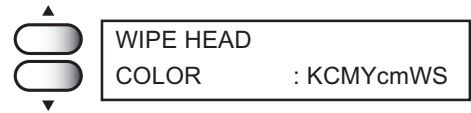

8. Press the [ENTER] key.



9. Select the number of wiping (1 to 9) by pressing the jog key [▲] or [▼].

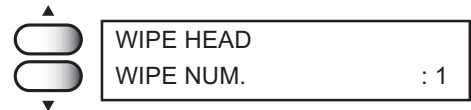

10. Press the [ENTER] key.



11. Press the [ENTER] key.

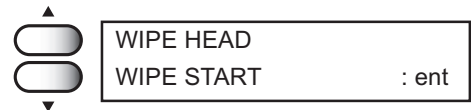

12. Wiping is started.

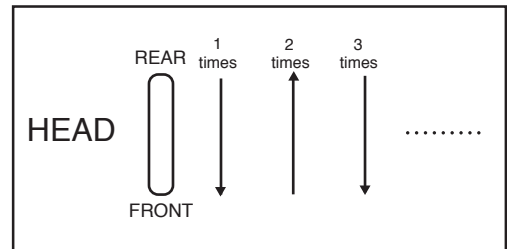

Action of suction

Chapter 4

Setting function

This chapter describes setting functions.

Table of contents

Application functions	4-2
Registering two or more printing conditions at a time (Selecting a type)	4-4
Setup functions	4-5
Setting the operation of the registration mark detection [MARK SENSOR]	4-8
Turning off UV Irradiation device [UV LAMP OFF]	4-14
Change the display language [DISPLAY]	4-15

Application functions

Of the menus that are provided for setting printing conditions for the device, the menu for setting up the device functions is called the function menu. In order to set printing conditions properly, it is necessary to understand the structure and operation of the function menu. (For "Maintenance" of the function menu, see Chapter 5 "Maintenance")

Before setting

The basic operation of the function menu for setting individual printing conditions is explained below. Set the individual printing conditions in the function menu after performing the following three operations.

- 1. Check that the menu mode is the LOCAL mode.**
- 2. Check that the language in which to display characters on the LCD has been selected.**
- 3. Select a Type to register the sequence of set printing conditions.**

Before setting the printing conditions in the function menu, confirm the basic operations and then set the individual printing conditions described on the pages that follow.

Checking the menu mode

Check the menu mode before setting the printing conditions.

The menu mode must be either the LOCAL mode or the FUNCTION mode.

Check also that the mode displayed on the LCD is either <<LOCAL>> or <<FUNCTION>>.

Basic operations of menus

This section describes how to change over the operation modes and how to operate the menus.

The following gives the key operation flow to invoke menus.

For detailed menu configuration, refer to Appendix.

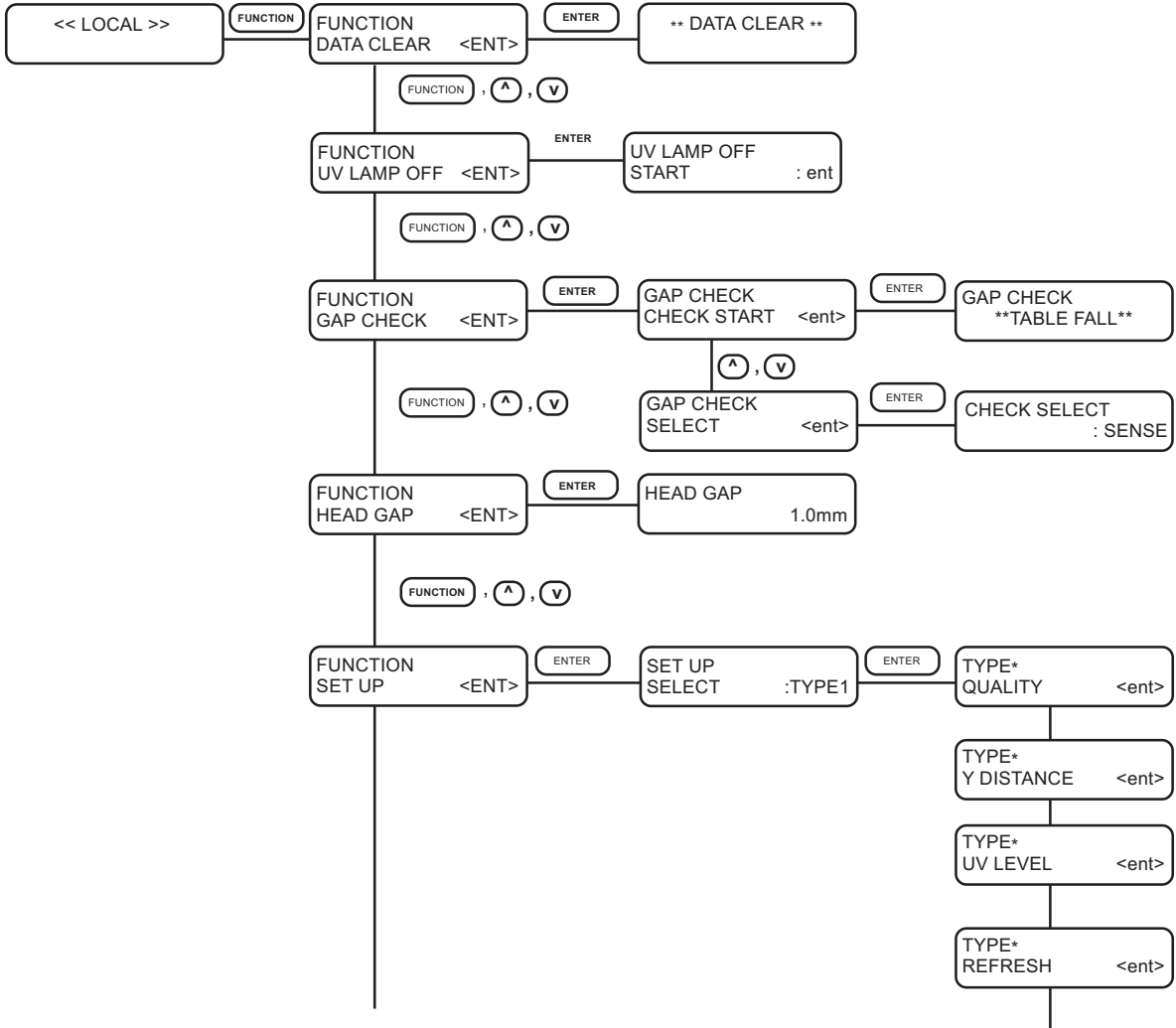

Registering two or more printing conditions at a time (Selecting a type)

Register a sequence of printing conditions set in the FUNCTION mode in the memory of the device. By allocating the sequence of printing conditions to any of Types 1 through 4, it is possible to reuse the same printing conditions registered by type. It is, therefore, convenient to allocate different printing conditions to different types according to the media and printing method used. The procedure for allocating a specific sequence of printing conditions to a type is described below. Here, the method of registration by allocating printing conditions to a particular type is explained.

STEPS:

1. Make sure that the LOCAL mode is displayed.

```
<< LOCAL >>
```

2. Press the [FUNCTION] key.

FUNCTION
 FUNCTION
 DATE CLEAR < ENT >



3. Select [SET UP] by pressing the [▼] key.

 FUNCTION
 SET UP < ENT >

4. Press the [ENTER] key.

ENTER
 SET UP
 SELECT : TYPE1

5. Select any of Types 1 through 4 by pressing the [▲] or [▼] keys.

 SET UP
 SELECT : TYPE3

6. Press the [ENTER] key.

Setting Printing Conditions.
 (Page 4.5 through 4.14)

ENTER
 TYPE3
 PRINT MODE < ent >

Changing the type

If printing conditions for types 1 through 4 have already been registered, settings can be selected according to the printing simply by selecting the type.

1. Perform steps 1 through 5 above.

Select a type.

```
SET UP  
SELECT : TYPE1
```









2. Press the [END] key.

Printing with the printing condition registered for the selected type is possible.

END
 TYPE3
 PRINT MODE < ent >

Setup functions

The function mode provides 9 set functions and a set function contains 9 set functions. The set functions are outlined below.

Function names		Summary
Data clear	 P.2-24	Data received are cleared when aborting the printing or in prior to the execution of the [COPY] function.
UV lamp OFF	 P.4-14	Turn the UV lamp off.
Gap Check	 P.2-13	Set the gap checkk when media setting
Head Gap*	 P.2-9	Adjust the height between print head and table.
Set up	Type	Register a sequence of printing conditions set.
	Quality	Set the print quality.
	Y Distance	Fine adjustment for the printing data according to the scale
	UV level	Adjust the UV lamp volume.
	Refresh	Solidification of ink can be prevented by refreshing the head during printing.
	Priority	Specifies whether the values set on the device (print) are given priority or the values set.
	Ink Layers	Sets the number of overprinting if ink coloring is poor.
	Color pattern	Print a color pattern on the left edge of media to check the nozzle out.
	UV SCAN ADD	Sets UV irradiation at starting/ ending of drawing.
	MM/INCH	Set a unit of set values displayed.
Setup reset	Resets the current printing conditions.	
Maintenance	 Chapter 5	Operatiing maintenance of the interior carriages
Origin	 P.2-15	Set the origin for printing.
Mark Sensor	 P.4-8	Makes settings necessary for detecting registration marks and detects these marks.
DISPLAY	 P.4-15	Set the display language.

[Quality]

Sets the print quality.

[STD] : Standard image quality

[Fine] : High image quality and low printing speed

[HIGHspd] : High printing speed and slightly inferior image quality

[Y DISTANCE]

Fine adjustment for the printing data according to the scale

The setting value for the fine adjustment : $\pm 0.39\%$

[UV Level]

Adjusts the light intensity. Normally, set [NORMAL]. Also setting [LAYER] allows the setup the UV level for at most 4 layers according to each layer.

- [NORMAL] : Standard light intensity**
- [HIGH] : Strong light intensity**
- [LOW] : Weak light intensity**
- [NONE] : Close the shutter of the UV lamp to print.**
- [NOPRINT] : Irradiate it by the strong light level without printing.**
- [LAYER] : Select the UV level according to each edition (layer).
Setting is available for at most 4 editions.**

[Refresh]

Solidification of ink can be prevented by refreshing the head during printing. If this function is executed in a dusty place or dry place, ink in the head will be likely to solidify.

A larger level results in more number of refreshes.

Number of refreshes : Level 0-3

[Priority]

Specifies whether the values set on the device (print) are given priority or the values set on the computer (host) are enabled as for the following five functions.

•Print Mode

•Overprint

[HOST] : The printing operation is performed with priority given to the printing conditions set on the computer.

[PLOT] : The printing operation is performed with priority given to the printing conditions set on the device.

[Ink Layers]

Sets the number of overprinting if ink coloring is poor.

The number of Overprinting : 1-9

[Color pattern]

Print a color pattern on the left edge of media to check the nozzle out while plotting.

[ON] : Color pattern is printed at +20mm from left edge of maximum printable area.

[OFF] : Color pattern is not printed.

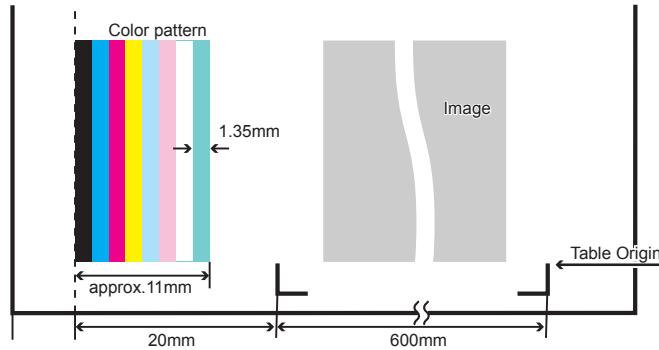

[UV Scan Add]

In the area where the drawing has just completed, sometimes the UV ink is not hardened due to insufficient UV irradiation. In this case, a setting is made for performing the scanning while irradiating UV in the vicinity of drawing completion.

UV SCAN ADD : 0-9 (No scanning at 0)

During drawing, the media is warmed up by heat of the UV lamp.

Around the starting point of drawing, the media may not be warmed up and adhesion of the UV ink may be low. In this case, a setting is made for performing the scanning while irradiating UV in the vicinity of drawing start.

UV SCAN BEFORE : 0-9 (No scanning at 0)

[mm/ inch]

Set a unit of set values displayed.

When the device is shipped from the factory, the unit of display is set to "mm" (millimeter).

[mm] : Numerics are expressed in millimeters.

[inch] : Numerics are expressed in inches.

[Setup Reset]

This function resets the current printing conditions to the factory-set printing conditions.

Execute this function for each of the types of set printing conditions.

[Enter] : The setup reset.

[END] : The setup do not reset.

Setting the operation of the registration mark detection [MARK SENSOR]

Before detecting registration marks, make settings necessary for detection.

In addition, check the response of the Mark sensor. Registration marks are detected when printing. (☞ P.2-21)

Set the operation of the registration mark detection [MARK SETUP]

This function is used to automatically detect a registration mark.

Correct the inclination of the sheet loaded on the device, origin of printing and distance between registration marks. Printing on printed media is enabled by compensating the inclination of the set sheet and the printing origin.

The following types of the registration marks are to be read.



- The initial setting for [DETECT] operation is OFF. Therefore, no messages are indicated when printing.
- Once the device detects marks, the origin is established at the location of MARK1. If you establish another origin at a different location using the jog key (arrow key), the origin is rendered effective.

Registration mark condition

Printed registration mark is required to fulfill all the following conditions.

- * The registration mark length must be 4 - 40mm on a side.
- * The line width of mark shall be equal to or more than 0.3 mm and equal to or less than 0.5 mm.
- * To detect the registration marks, no stain or print image should be in between the marks.



Mark Form : TYPE1

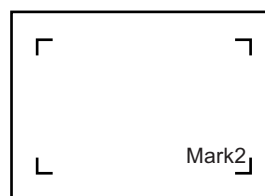

Mark Form : TYPE2

TYPE1

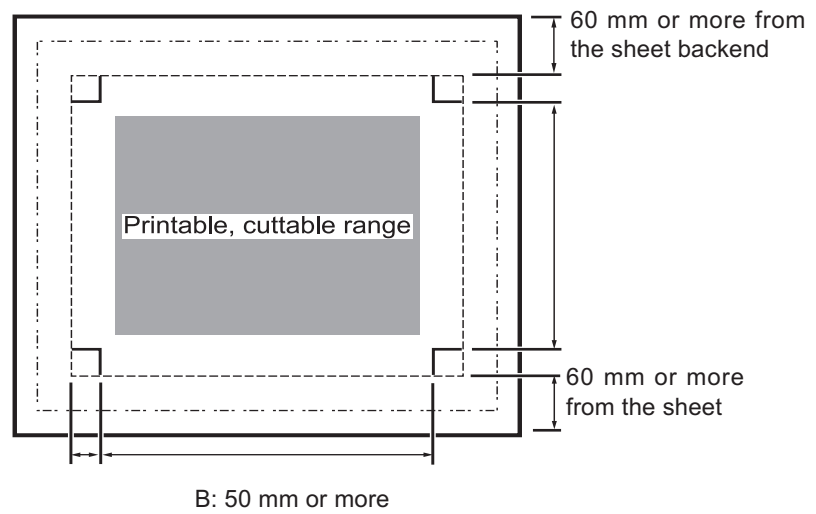

TYPE2

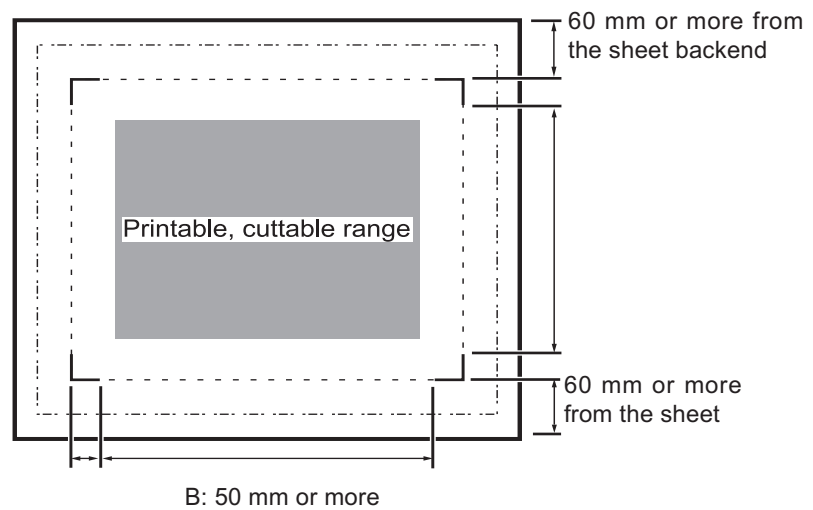

Operation settings for detection of marks

The settings of the following three functions are specified when detecting a mark.

An underline shows the initial value.

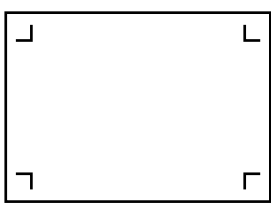
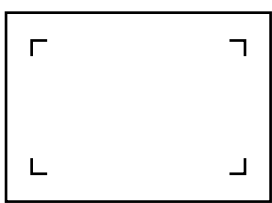
Function	Setting	Description
MARK DETECT	<u>OFF</u>	Data printing or copy printing is to be carried out on ordinary media.
	Always	When the registration mark positions are different for each printing operation, registration marks are detected using the light pointer for each data or copy printing operation.
	1	When registration marks at the same positions are used for data or copy printing, checking the registration mark detection positions using the light pointer causes the registration marks to be automatically detected next time. When setting this function, place the media at the same origin position. After the main unit power is set ON or data clear is executed, registration marks are detected once.
Size	4-40mm	Setting the detection offset of the registration marks. In case the horizontal and vertical lengths differ, set the value to the shorter length. <div style="text-align: center;">  </div>
MARK FORM	<u>TYPE1</u> TYPE2	Select either one of the following types of the registration mark. <div style="display: flex; justify-content: space-around; align-items: center;"> <div style="text-align: center;"> <p>Mark: TYPE1</p>  </div> <div style="text-align: center;"> <p>Mark: TYPE2</p>  </div> </div>
SPEED	1~10cm/s	Sets the speed for detecting the registration marks with the photoelectric eye sensor. Initial value is 5cm/s.

Set the operation for registration marks detection

STEPS:

1. Make sure that the Local mode is displayed.

<< LOCAL >>

2. Press the [FUNCTION] key.

FUNCTION
DATE CLEAR < ENT >

3. Select the [MARK SENSOR] by pressing the [▼] key.

FUNCTION
MARK SENSOR < ENT >

4. Press the [ENTER] key.

ENTER
MARK SENSOR
MARK SETUP < ENT >

5. Select the [MARK SETUP], then press the [ENTER] key.

ENTER
MARK SETUP
DETECT :OFF

6. Select an item other than [OFF] for [DETECT] by pressing the [▲] or [▼] keys.

▲
MARK SETUP
DETECT :ALWAYS
▼



- For the details on numbers of the detected registration marks, refer to the Page 4-10.

7. Press the [ENTER] key.

ENTER
MARK SETUP
SIZE :10mm

8. Enter a value for [SIZE] by pressing the [▲] or [▼] keys.

▲
MARK SETUP
SIZE :15mm
▼

9. Press the [ENTER] key.

ENTER
MARK SETUP
FORM :TYPE1

10. Select the [FORM] by pressing the [▲] or [▼] keys.

▲
MARK SETUP
FORM :TYPE2
▼

11. Press the [ENTER] key.

ENTER
MARK SETUP
SPEED :5cm/s

12. Enter the setting value of the [SPEED] by pressing the [▲] or [▼] keys.

▲
MARK SETUP
SPEED :10cm/s
▼

13. Press the [ENTER] key.

ENTER
MARK SENSOR
MARK SETUP < ENT >

Check the sensor for the registration mark detection [MARK Check]

Check the sensor.

Registration mark condition

Printed registration mark is required to fulfill all the following conditions.

- * The registration mark length must be 4 - 40mm on a side.
- * The line width of mark shall be equal to or more than 0.3 mm and equal to or less than 0.5 mm.
- * To detect the registration marks, no stain or print image should be in between the marks.

STEPS:

1. Make sure that the Local mode is displayed.



2. Press the [FUNCTION] key.



3. Select the [Mark sensor] by pressing the [▼] key.



4. Press the [ENTER] key.



5. Select the [Mark check] by pressing the [▲] or [▼] keys.

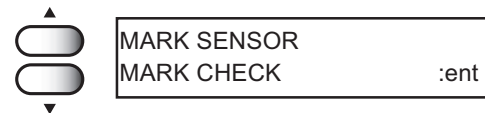

6. Press the [ENTER] key.



7. Move the light pointer to the "Mark detection position" by pressing [▲], [▼], [◀] or [▶] keys.



Make a margin 1mm, and more.

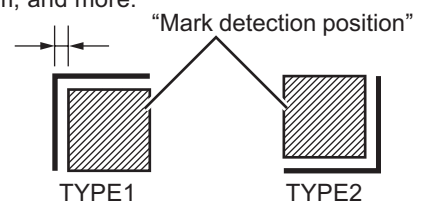

8. Press the [ENTER] key.

The registration mark detection starts.

When no registration marks are detected, an error is indicated.



MARK SENSOR	
MARK CHECK	:ent

9. The registration mark detection completes.

Movement of Mark sensor

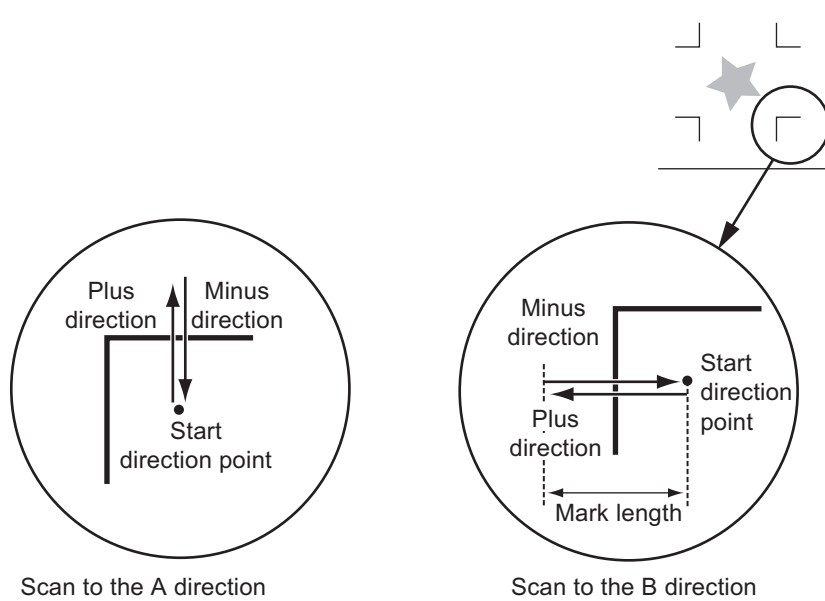

Turning off UV Irradiation device [UV LAMP OFF]

The UV irradiation device automatically goes OFF when no printing is carried out 30 minutes or more. When printing is to be carried out with a long interval, the UV lamp can be set OFF to make the UV lamp service life longer. When printing restarts, the UV irradiation device automatically restarts and the UV lamp goes ON.



- UV OFF timer setting is available. Refer to “Setting UV lamp off duration” (P.5-18). Initial setting value is 30 minutes
- When Setting value is [ON] in the [UV Lamp] - [OFF TIMER] menu or no printing is to be carried out long time (30 minutes or more), set the UV lamp OFF.
- Once the UV lamp is set OFF, it takes approximately 10 minutes to turn the UV lamp ON and make printing enabled.

STEPS:

1. Make sure that the **LOCAL** mode is displayed.

<< LOCAL >>

2. Press the **[FUNCTION]** key.



FUNCTION
DATE CLEAR < ENT >

3. Select **[UV LAMP OFF]** by pressing the **[▼]** key.



FUNCTION
UV LAMP OFF < ENT >

4. Press the **[ENTER]** key.



UV LAMP OFF
START :ent

5. Press the **[ENTER]** key.



The UV irradiation device starts setting OFF.

6. When the UV lamp is set OFF and a completion message has appeared, return to step 3.

UV LAMP OFF
COMPLETED

FUNCTION
UV LAMP OFF < ENT >

Change the display language [DISPLAY]

Display language enable to change Japanese or English. Print default is English. This procedure explains how to change Display language to Japanese. Set Japanese display mode.

STEPS:

1. Make sure that the mode is LOCAL mode.



2. Press the [FUNCTION] key.



3. Select [DISPLAY] by pressing the [▲] key.



4. Press the [ENTER] key.



5. Select the language by pressing the [▲] or [▼] keys.



6. Press the [ENTER] key.
The device enters the LOCAL mode.

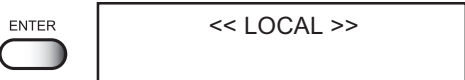

Chapter 5

Maintenance

This chapter describes maintenance procedures including how to resolve deteriorated printing quality and replace the UV lamp, so that this unit can be used in good conditions.

Table of contents

Maintenance of the device	5-2
Drawing setup conditions [LIST]	5-3
When media thickness is changed [Print Adjust]	5-4
Cleaning the station interior [Station]-[CarriageOut]	5-6
If nozzles are clogged even after the cleaning function is executed ...	5-7
Regular wiping function [INT. WIPING]	5-8
Changing the ink set [INK SET]	5-9
Ink exchanging procedure	5-14
Select a head for small amount cleaning [HEAD MAINTENANCE]	5-15
Replacing UV Lamp	5-16
Resetting UV lamp irradiation duration	5-17
Setting UV lamp off duration	5-18
Checking UV ink curing level	5-19
UV illumination level check	5-23
Prevent the nozzle clogging of spot color [SP.REFRESH]	5-28
Displaying device information [INFORMATION]	5-29
Set the type of the cap rubber [CAP RUBBER]	5-30

Maintenance of the device

The term “maintenance” as used herein refers to the operation that has to be performed to keep the device in good operating condition.

To carry out maintenance of the device, select [MAINTENANCE] from the function menu and make the necessary settings.

Invoking a maintenance function

In order to execute any of the maintenance functions, it is necessary to perform the following operation on the operation panel.

You have to understand how to invoke the desired maintenance function to carry out maintenance.

STEPS:

1. Make sure that the LOCAL mode is displayed.

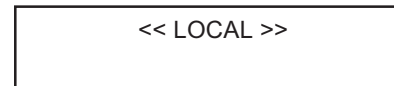

2. Press the [FUNCTION] key.



3. Press the [▲] or [▼] keys until the display gives the indication [MAINTENANCE].



4. Press the [ENTER] key.

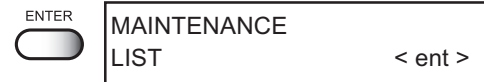

5. Select the next operation.

Setup functions

Name	Function	Page
LIST	Prints the set condition of the device.	P.5-3
PRINT ADJUST	Adjusts the dot position.	P.5-4
STATION	Cleans the inside of the station and flashing tray.	P.5-6
FILL UP INK	Use this function when nozzle clogging is not solved.	P.5-7
WIPE HEAD	Ink drops stuck on the nozzle side is cleaned.	P.3-18
INT. WIPING	Wipe off the nozzle at intervals.	P.5-8
INK SET	Select the ink color set of ink cartridge.	P.5-9
INK CHANGE	Perform ink change.	P.5-14
WATER CHANGE	Replace the water for water heater tank.	P.3-8
WHITE MANT	Regular maintenance for white ink is performed.	P.3-13
HEAD MAINTENANCE	Select a head for small amount cleaning when power on.	P.5-15
UV LAMP	Replace the UV lamp deteriorated.	P.5-16
SP.REFRESH	When white ink is set, it changes the setting to perform refresh appropriate for white ink.	P.5-28
INFORMATION	Display the firmware version and serial number for the device	P.5-29
CAP RUBBER	Set the type of the cap rubber.	P.5-30

Drawing setup conditions [LIST]

This function outputs the current settings of the device.
They are useful in carrying out maintenance of the device.

- 1.SET UP : Indicates a value that is specified with the FUNCTION.
- 2.PRINT ADJUST : Indicates a correction value for dot position.
- 3.VERSION : Indicates the version of the firmware and memory capacity of the device.
- 4.PARAMETER : Used for service engineer for maintenance.



- When this function is used to output data commands on a sheet of paper, use 297mm x 210mm or larger size with the long side set horizontally.
- Gap check is performed when the head gap adjustment has not been checked. (☞P.2-13)

```

LIST (System Ver1.04) (F Ver . ) S-N :
(1) SET UP < TYPE 1 >
PRINT METHOD STD (HOST) STD (HOST) STD (HOST) STD (HOST)
UV LEVEL HIGH HIGH HIGH HIGH
REFRESH
DRAWING LEVEL1 LEVEL1 LEVEL1 LEVEL1
WAITING LEVEL1 LEVEL1 LEVEL1 LEVEL1
INK LAYERS 1 (HOST) 1 (HOST) 1 (HOST) 1 (HOST)
AUTO CLEAN OFF OFF OFF OFF
RM-INCH MM MM MM MM
(2) ORIGIN
X OFFSET 0mm
Y OFFSET 0mm
(3) DISPLAY ENGLISH
(4) PRINT ADJUST
PATTERN 1 PATTERN 2 PATTERN 3 PATTERN 4
0.0 0.0 0.0 0.0
PATTERN 5 PATTERN 6 PATTERN 7
0.0 0.0 0.0
(5) REPLACE CNT
UV USED TIME 366s
GAP CHECK OK
INK REMAIN K: % C: % M: % Y: % B: % W: % G: %
SHOT COUNT K: 5817 C: 2692632 M: 0 Y: 0 B: 0 W: 0 G: 0
SCAN COUNT 10 (1000)
DRAW LENGTH 0 ft
DRAW AREA 42 sq.ft
USE TIME h
  
```

STEPS:

1. Set a sheet of paper, use 297mm x 210mm or larger size with the long side set horizontally, and set the Origin.
2. Select the [LIST] from the [MAINTENANCE].
(☞ P.5-2)
3. Press the [ENTER] key.
The list will be printed automatically.
4. Press the [END] key twice, and the device returns to the LOCAL mode.

MAINTENANCE
LIST < ent >



** LIST **



<< LOCAL >>

When media thickness is changed [Print Adjust]

When the head height is adjusted, be sure to correct the dot positions.

This function corrects the dot positions to ensure that the accurate printing result is obtained.

The dot positions are corrected by comparing the ink dropping positions on each of the six test patterns between the two printing directions.

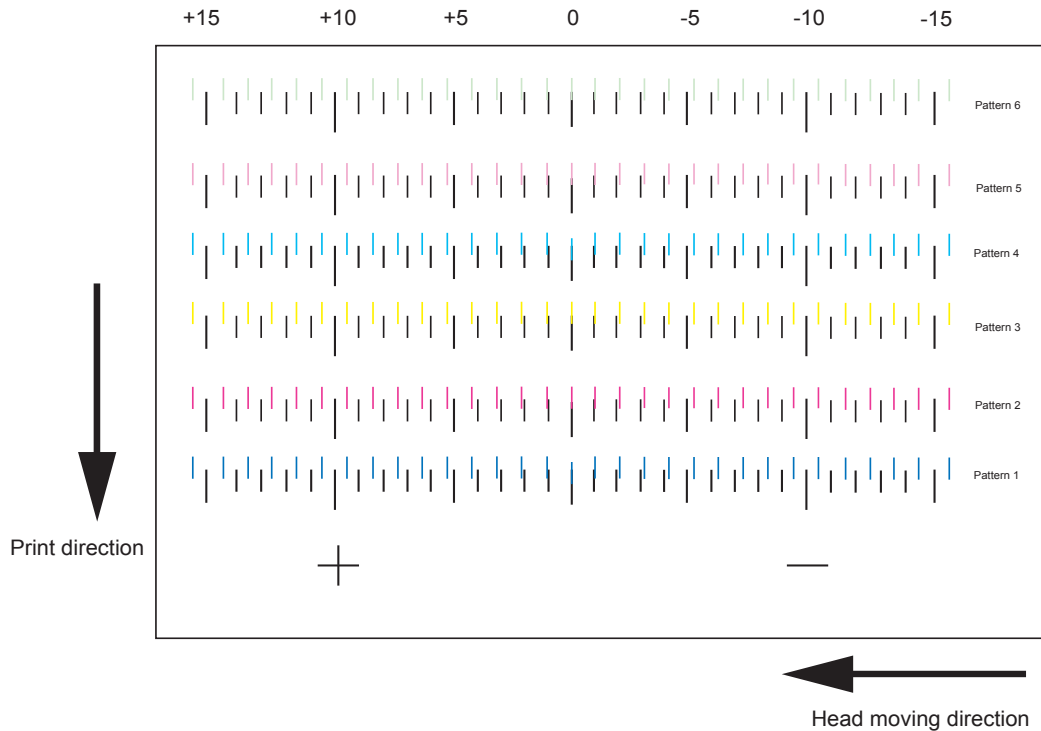

Always perform Print Adjust (dot position correction) whenever the head height is changed.

STEPS:

1. Set a sheet of paper, use 297mm x 210mm or larger size with the long side set horizontally, and set the Origin.
2. Select the [PRINT ADJ] from the [MAINTENANCE]. (☞ P.5-2)
3. Press the [ENTER] key.
Gap check is performed when the head gap adjustment has not been checked. (☞ P.2-13)

MAINTENANCE PRINT ADJ	< ent >
--------------------------	---------



PRINT ADJUST PRINT START	: ent
-----------------------------	-------

4. Press the [ENTER] key.

Printing of the test patterns for the correction of dot position starts. There are six types of test patterns that are printed.

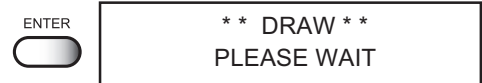

5. Press the [▲] or [▼] keys to correct the dot position of pattern 1.

The six test patterns that are output are sequentially named [PATTERN 1] to [PATTERN 6].

Select the correct dot positions on [PATTERN 1] using the [▲] or [▼] keys.

Select the dot positions that make a straight line on the test pattern.

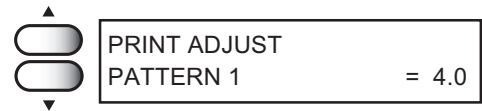

Select the dot positions 4.0 that make a straight line on the test pattern in two printing direction.

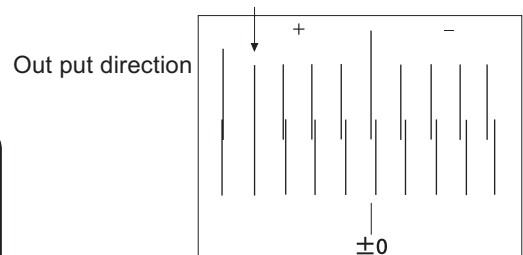

 CAUTION

- If the pattern correction value for straight lines is not within -15 through +15, adjust the head height and then correct it again with [Print Adjust].

6. Press the [ENTER] key.

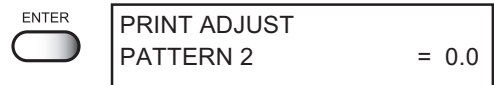

7. Repeat Steps 5 and 6 to correct the dot positions on Patterns 2 to 6.

Select the correct dot positions on each of the patterns.

Enter the dot position correction value on Patterns 1 to 6 and then terminate dot position correction.



8. Press the [ENTER] key to finish this procedure.

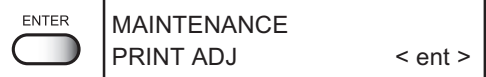

9. Press the [END] key twice, and the device returns to the LOCAL mode.

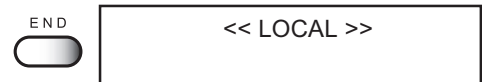

Cleaning the station interior [Station]-[CarriageOut]

Move the carriage when cleaning the station interior.



- Do not move the carriage out of the capping station by hand.
Use the appropriate operation key to move the carriage.

STEPS:

1. Select the [STATION] from the [MAINTENANCE]. (☞ P.5-2)

MAINTENANCE STATION	< ent>
------------------------	--------

2. Press the [ENTER] key.

ENTER 	STATION CARRIAGE OUT	:ent
--	-------------------------	------

3. Press the [ENTER] key.

The carriage moves above the table. Suction nozzle is moving to the front, then the carriage moves from the station.

ENTER 	STATION COMPLETED	: ent
---	----------------------	-------

4. Open the maintenance cover, then perform the following maintenance works for the station interior.

For the procedures for cleaning the cap, suction nozzle and carriage, see Chapter 3.

5. Close the maintenance cover, then press the [ENTER] key.

ENTER 	PLEASE WAIT
--	-------------

6. The device enters the LOCAL mode.

<< LOCAL >>

If nozzles are clogged even after the cleaning function is executed

If nozzle clogging is resolved after HEAD CLEANING (👉 P 2.20) perform the following functions.

STEPS:

1. Select the [FILL UP INK] from the [MAINTENANCE]. (👉 P.5-2)

```
MAINTENANCE
FILL UP INK      < ent >
```

2. Press the [ENTER] key.



```
FILL UP INK
COLOR          :KCMYcmW
```

3. Select the print head color by pressing the [◀] or [▶] keys.



```
FILL UP INK
COLOR          :KCMYcmW
```

4. Press the [▲] or [▼] keys to display the print head color must be filled.



```
FILL UP INK
COLOR          :* CMY * * *
```

Put symbol [*] for colors to be filled with no ink.

5. Press the [ENTER] key.



```
FILL UP INK
FILL UP INK START :ent
```

6. Press the [ENTER] key again to start the ink filling.



```
** INK FILL UP **
*****-----
```

7. When filling of ink is completed, the menu returns.

```
MAINTENANCE
FILL UP INK      < ent >
```

8. Press the [END] key twice, and the device returns to the LOCAL mode.



```
<< LOCAL >>
```

Regular wiping function [INT. WIPING]

Use this function to prevent the ink spray on the print head surface.

This function enables to wipe off the condensed ink as wiping the nozzle at intervals after specified number of plotting.

STEPS:

1. Select the [INT. WIPING] from the [MAINTENANCE]. (👉 P.5-2)

MAINTENANCE	
INT. WIPING	< ent>

2. Press the [ENTER] key.

ENTER	INT. WIPING	
	INT.	:PRINT CNT

3. Press the [▲] or [▼] keys to select the maintenance interval. (SCAN CNT, PRINT CNT)

▲	INT. WIPING	
▼	INT.	:SCAN CNT



- [PRINT COUNT] cleans the nozzle surface at the end of printing if it exceeded the set number of scans (100 to 800 times).
- [PRINT COUNT] cleans the nozzle surface per the set number of printings (1 to 4 times).

4. Press the [ENTER] key.

ENTER	INT. WIPING	
	SCAN CNT	: 100

6. Press the [▲] or [▼] keys to set the number of times.

▲	INT. WIPING	
▼	SCAN CNT	: 200

Setting value:

SCAN CNT: 100 to 800(In 100 unit)

PRINT CNT: 1 to 4

7. Press the [ENTER] key.

ENTER	MAINTENANCE	
	INT. WIPING	< ent>

8. Press the [END] key twice, and the device returns to the LOCAL mode.

END	<< LOCAL >>
-----	-------------

Changing the ink set [INK SET]

The standard ink set for this unit has 7 colors (black, cyan, magenta, yellow, light cyan, light magenta and white). You may change it to the following ink sets:

- *Changing to 6-color ink set (only 6 colors, white ink is not used)
- *Changing to 8-color ink set with addition of spot color
- *Changing to spot color instead of White ink



CAUTION

- Don't open the cover or turn the power OFF while changing the ink set, otherwise changing of the ink set could not be performed.
- Set the ink cartridge containing sufficient quantity of ink. If it does not contain sufficient quantity of ink, changing of the ink set could not be performed properly because of the ink fill up abnormality.
- Check the capacity of waste ink tank. If the tank is filled with the waste ink, dispose it before performing this procedure. (P.3-7)

Changing to 6-color ink set

The following procedures explain about changing from 7-color ink set to 6-color ink set.

STEPS:

1. Select the [INK SET] from the [MAINTENANCE].
(P.5-2)

MAINTENANCE INK SET	< ent >
------------------------	---------

2. Press the [ENTER] key.

ENTER 	INK SET Uv-7	[KCMYcmS]
-----------	-----------------	------------

3. Select ink set corresponding to 6-color ink set.

Press the jog key [] or [], select [Uv-6 [KCMYcm].

▲ ▼	INK SET Uv-6	[KCMYcm]
------------	-----------------	-----------

4. Press the [ENTER] key.

ENTER 	INK SET SET UP OK?	:KCMYcm :ent
-----------	-----------------------	-----------------

5. Press the [ENTER] key.

ENTER 	INK SET REMOVE CARTRIDGE	:*****W
-----------	-----------------------------	---------

6. Remove the White ink cartridge.

7. Press the [ENTER] key.



WASHING
PLEASE WAIT

8. When the right is shown, set the cleaner cartridge.

INK SET :*****W
SET CLEAN TOOL

9. Press the [ENTER] key.

The cleaner is sucked in and cleaning is performed.



WASHING
PLEASE WAIT

10. When the right is shown, remove the cleaner cartridge.

INK SET :*****W
REMOVE TOOL

11 Press the [ENTER] key.

The cleaner is discharged to the waste ink tank.



WASHING
PLEASE WAIT

When the cleaner is discharged, the screen returns to the local mode.

INK SET
PLEASE WAIT

<<LOCAL>>



- When the cleaner is discharged, the screen returns to the local mode.

Changing to 8-color ink set with addition of spot color

There are two kinds of ink set in this ink set.

1. Uv-8 [KCMYcmWS] : The ink set which spot ink is added to 7-color ink set.
2. Uv-8 [KCMYcmSs] : The ink set which white ink of the 7-color ink set is changed to spot color and one more spot ink is added as 8th color.

The following procedures explain about changing from 7-color ink set to 8-color ink set with addition of spot color.

STEPS:

1. Select the [INK SET] from the [MAINTENANCE].

 P.5-2)

```
MAINTENANCE
INK SET           < ent >
```

2. Press the [ENTER] key.

```
ENTER
INK SET
Uv-7           [KCMYcmS ]
```

3. Make sure that 8-color ink set is displayed and press [ENTER] key.

Select [Uv-8 [KCMYcmWS]] .

```
ENTER
INK SET           :KCMYcmWS
SET UP OK?       :ent
```

4. Press the [ENTER] key.

```
ENTER
INK SET           :*****S
SET CARTRIDGE
```

5. Set spot color cartridge.



- Set the ink cartridge containing sufficient quantity of ink. If it does not contain sufficient quantity of ink, changing of the ink set could not be performed properly because of the ink fill up abnormality.

6. Press the [ENTER] key.

The ink fill up is started.

```
ENTER
**INK FILLUP**
PLEASE WAIT
```

When the ink fill up is completed, the screen returns to the local mode.

```
INK SET           :KCMYcmWS
PLEASE WAIT
```



- When the cleaner is discharged, the screen returns to the local mode.

```
<<LOCAL>>
```

Changing white ink to spot color

The following procedures explain about changing from 7-color ink set to 7-color ink set using spot ink instead of White ink.

STEPS:

1. Select the [INK SET] from the [MAINTENANCE].
(☞ P.5-2)

```
MAINTENANCE
INK SET          < ent >
```

2. Press the [ENTER] key.



```
INK SET
Uv-8          [KCMYcmWS]
```

3. Select the 7-color ink set.
Press the jog key [▲] or [▼], and select [Uv-8 [KCMYcmS] .



```
INK SET
Uv-7          [KCMYcmS ]
```

4. Press the [ENTER] key.



```
INK SET          :KCMYcmS
SET UP OK?      :ent
```

5. Press the [ENTER] key.



```
INK SET          :*****W
REMOVE CARTRIDGE
```

6. Remove the White ink cartridge.

7. Press the [ENTER] key.
Unnecessary ink is cleaning.



```
**WASHING**
PLEASE WAIT
```

8. When the right is shown, set the Cleaner cartridge.

```
INK SET          :*****W
SET CLEAN TOOL
```

9. Press the [ENTER] key.
Cleaner is sucked and clean.



```
**WASHING**
PLEASE WAIT
```

10. When the right is shown, remove the cleaner cartridge.

INK SET :*****W
REMOVE TOOL

11. Press the [ENTER] key.

The cleaner is discharged to the waste ink tank.



WASHING
PLEASE WAIT

12. When the right is shown, set the spot ink cartridge.

INK SET :*****S
SET CARTRIDGE

13. Press the [ENTER] key.

New ink cartridge is started to fill up. The Local mode is displayed after filling up ink.



INK FILLUP
PLEASE WAIT

INK SET :KCMYcmW
PLEASE WAIT

<<LOCAL>>

Ink exchanging procedure

Ink exchanging is performed as following procedure.

STEPS:

1. Select the [INK CHANGE] from the [MAINTENANCE]. (👉 P.5-2)

MAINTENANCE
INK CHANGE < ent >

2. Press the [ENTER] key.

ENTER
INK CHANGE
COLOR :KCMYcmW

3. Select the print head color by pressing the [◀] or [▶] keys.

◀ INK CHANGE
COLOR :KCMYcmW ▶

4. Display the print head color must be changed by pressing the [▲] or [▼] keys.

▲ INK CHANGE
COLOR :* CMY * * * ▼

Put symbol [*] for colors to not be changed.

5. Press the [ENTER] key.

ENTER
INK CHANGE
REMOVE CARTRIDGE

6. Take out the ink cartridges.

Discharge of the filled ink is started.

** WASHING **
PLEASE WAIT

7. When the display shown at right appears, set the cleaning cartridge.

ENTER
INK CHANGE
SET CLEAN TOOL

8. Press the [ENTER] key.

Cleaning fluid is suctioned up.

** WASHING **
PLEASE WAIT



- The washing liquid is separately available from your local distributor.

9. When the display shown at right appears, remove the cleaning cartridge.

The discharge of the cleaning fluid is started.

INK CHANGE
REMOVE TOOL

** WASHING **
PLEASE WAIT

10. Install the ink cartridges to the ink stations after discharging.

ENTER
INK CHANGE
SET CARTRIDGE

- 11 Press the [ENTER] key.

Ink filling is started.

** INK FILL UP **
PLEASE WAIT

When ink fill-up operation is completed, the menu returns to the Ink Change.

MAINTENANCE
INK CHANGE < ent >

Select a head for small amount cleaning [HEAD MAINT E]

Select a head to execute small amount cleaning when turned on power.

STEPS:

1. Select the [HEAD MAINT E] from the [MAINTENANCE]. (☞ P.5-2)

MAINTENANCE
HEAD MAINT E < ent >

2. Press the [ENTER] key.



HEAD MAINT E.
COLOR :KCMYcmW

3. Select a ink cartridge to execute a small amount cleaning by pressing the [◀] and [▶] keys.



HEAD MAINT E.
COLOR :KCMYcmW

4. Select ON or OFF of small amount cleaning execution by pressing the [▲] and [▼] keys.



HEAD MAINT E.
COLOR :***YcmW

5. Press the [END] key twice to return to Local mode.



<<LOCAL>>

Replacing UV Lamp

The UV lamp is a consumable component.

This unit counts the duration of irradiation with the UV lamp and notifies you of the replacing timing.

Checking UV lamp irradiation duration

STEPS:

1. Make sure that the LOCAL mode is displayed.

<< LOCAL >>

2. Press the [ENTER] key several times.

The irradiation duration appears. The LCD display shows that the irradiation duration is 130 hours and 5 minutes.



UV USED TIME
130h 05m



- Refer to the “Displaying the information” . ( P 2-4)

3. Press the [ENTER] key to return to the local mode.



Replacing UV lamp

When the irradiation duration has exceeded the predetermined period of time, a message appears asking you to replace the UV lamp. When this message has appeared, contact your nearest sales agency or Mimaki sales office to replace the UV lamp as soon as possible.

Press the [ENTER] key to change the UV lamp.



! UV LAMP
! UV LAMP CHANGE :ent



- When the warning message has appeared, UV lamp should be replaced with a new one. Contact your nearest sales agency or Mimaki sales office.

Resetting UV lamp irradiation duration

After replacing the UV lamp, reset the irradiation duration stored in this unit.

STEPS:

1. Select the [UV LAMP] from the [MAINTENANCE]. (☞ P.5-2)

MAINTENANCE UV LAMP	<ENT>
------------------------	-------

2. Press the [ENTER] key.

ENTER UV LAMP LEVEL CHECK	<ent>
---------------------------------	-------

3. Select [INIT TIMER] by pressing the [▲] or [▼] keys.

▲ UV LAMP INIT TIMER ▼	<ent>
---------------------------------	-------

4. Press the [ENTER] key.

ENTER INIT UV TIMER INIT START	:ent
--------------------------------------	------

5. Press the [ENTER] key again.
The irradiation duration is initialized.

ENTER



When the operation completes, the indication shown on the right is restored.

UV LAMP INIT TIMER	<ent>
-----------------------	-------

7. Press the [END] key twice, and then the device returns to the LOCAL mode.

END	<<LOCAL>>
-----	-----------

Setting UV lamp off duration

Set the UV lamp OFF duration stored in this unit.

CONT. IRR. [OFF] UV irradiation device turns the lamp off automatically according to setting value. The initial setting value is 30 minutes.

CONT. IRR [ON] UV lamp is always lighting on. When turning the lamp off action, refer to the “Turning off UV irradiation device” to set the lamp to OFF. (☞ P.4-14)

STEPS:

1. Select the [UV LAMP] from the [MAINTENANCE]. (☞ P.5-2)

MAINTENANCE
UV LAMP <ent>

2. Press the [ENTER] key.

ENTER
UV LAMP
LEVEL CHECK <ent>

3. Select [OFF TIMER] by pressing the [▲] or [▼] keys.

▲
▼
UV LAMP
OFF TIMER <ent>

4. Press the [ENTER] key.

ENTER
UV OFF TIMER
CONT. IRR. : OFF

5. Select “OFF” for [CONT. IRR.] by pressing the [▲] or [▼] keys.

▲
▼
UV OFF TIMER
CONT. IRR. : ON
UV OFF TIMER
CONT. IRR. : OFF

6. Press the [ENTER] key.

ENTER
OFF TIMER
00h 00m

7. Enter the Off timer value by the minutes by pressing the [▲] or [▼] keys.

▲
▼
OFF TIMER
01h 30m

8. Press the [ENTER] key.

ENTER
UV LAMP
OFF TIMER <ent>

9. Press the [END] key, and then the device returns to the LOCAL mode.

END
<<LOCAL>>

Checking UV ink curing level

As the UV lamp is deteriorated, the ink curing level may be lowered.
Check the UV ink curing level and adjust the UV lamp light intensity, if necessary.

UV ink curing check test pattern

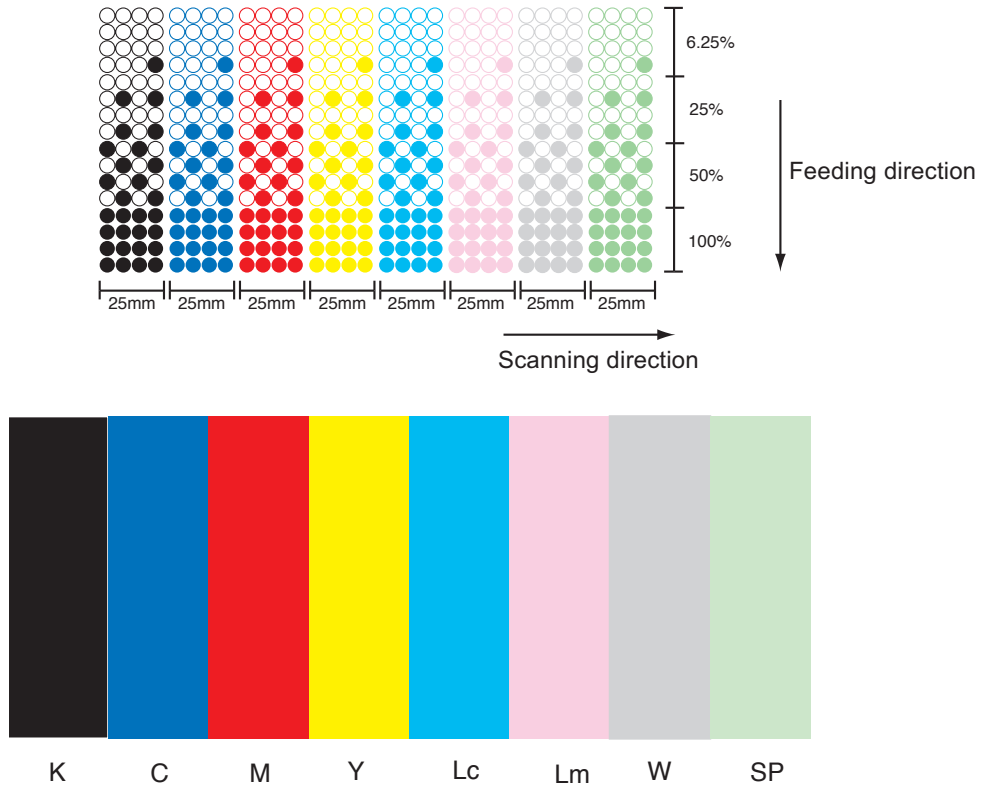

STEPS:

1. **Set media for the test pattern on the table.**

Set the vacuum switch ON , then set the printing origin.

2. **Make sure that the Local mode is displayed.**

<<LOCAL>>

3. **Press the [TEST] key.**

TEST TEST DRAW
NOZZLE CHK <ENT>

4. **Select the [HARDEN CHK] by pressing the [▲] or [▼] keys.**

▲
▼

TEST DRAW
HARDEN CHK <ENT>

5. **Press the [ENTER] key.**

ENTER HARDEN CHK
DPI : 300 x 300

6. Select the resolution for the test pattern by pressing the [▲] or [▼] keys.



7. Press the [ENTER] key.



8. Select the quality for the test pattern by pressing the [▲] or [▼] keys.



9. Press the [ENTER] key, then start TEST DRAW.

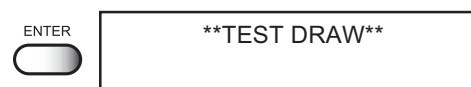

• If the temperature in the water heater or in the UV device has not reached the predetermined value, a message is indicated. In this case, printing is disabled. It is enabled when the error indication has disappeared.

UV NOT READY

WATER NOT READY

10. After the test printing has completed, check the test pattern.

If the UV light intensity goes lower, good printing pattern cannot be obtained. Go to the next step.

Adjusting UV light level

STEPS:

1. Make sure that the Local mode is displayed.

<<LOCAL>>

2. Press the [FUNCTION] key.

FUNCTION FUNCTION
DATA CLEAR <ENT>

3. Select the [SETUP] by pressing the [▼] key.

▼ FUNCTION
SET UP <ENT>

4. Press the [ENTER] key twice.

ENTER TYPE *
QUALITY <ent>

5. Select the [UV LEVEL] by pressing the [▼] key.

▼ TYPE *
UV LEVEL <ent>

6. Press the [ENTER] key.

ENTER TYPE *
UV LEVEL :NORMAL

7. Select the light level by pressing the [▲] or [▼] key.

▲
▼ TYPE *
UV LEVEL :LAYER

This display at the right indicates the [LAYER].
When selecting the other one except for the [LAYER], follow the procedure from STEP11.

8. Press the [ENTER] key.

ENTER TYPE *
LAYER 1 :HIGH

9. Select the layer by pressing the [◀] or [▶] key.

◀ ▶ TYPE *
LAYER 2 :HIGH

10. Select the light level by pressing the [▲] or [▼] key.

When selecting the [INVALID], the layer is printed by the light level of the previous layer after that.

Ex.: For 4 layers, select the [INVALID] of the layer 3 and the light level of the layer 1 and 2 become effective. That allows the repeatability of the layer by effective light level. This means the layer 3 is printed by the light level of the layer 1, and the layer 4 is printed by the light level of the layer 2.

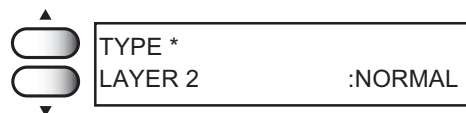

11. Press the [ENTER] key.





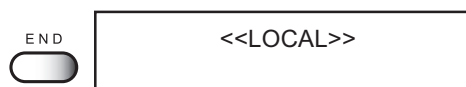

12. Press the [END] key three times, the device returns to the LOCAL mode.



13. Check the UV ink curing level again.

Set the media on the table, then draw the test pattern again for UV light intensity.  P.5-19



- If the UV ink curing level is not changed by adjusting the UV light intensity, the UV lamp is deteriorated.
 - * Check the UV lamp irradiation duration  P.2-4, 5-16
 - * When setting the UV level according to each layer, the waiting REMOTE mode can change the layer.  P.2-21
 - * Check the UV lamp irradiation level  P.5-23
 - * Contact to your distributor for replacing the UV lamp.  P.5-16

UV illumination level check

As the UV lamp is deteriorated, the ink curing level may be lowered. Check the UV illumination level by using attached UV illuminometer, if necessary. Refer to the illuminometer manual with option, Check the UV illumination level.

When the UV lamp level has exceeded the predetermined amounts of time, the following message appears to check the UV lamp level.

Press the [ENTER] key and then check the UV illumination level with UV illuminometer.



```
! UV LAMP
UV LEVEL CHK          :ent
```

UV illumination level check

Changing the level of the UV lamp may not improve the UV curing after printing. This case indicates that the lamp does not have enough illumination for curing because of the lamp wastage. Go through the following steps to check the UV illumination also when the message for confirmation of the illumination has appeared.

Touchstone of UV illumination level check

Indicator value for the changing UV lamp at factory setting and the value used after 1000 hours are described on inside of the UV illuminometer. Make sure that the average level with it.



- The UV lamp illumination level goes down as time goes by. After 1000 hours using, the level goes down approximately 30%.
In case the illumination level goes down significantly, contact your nearest sales agency or Mimaki sales office. The UV lamp could be broken. UV illumination level goes down gradually, not suddenly, without flickers of light after 1000 hours using. Well check UV ink curing level or the UV illumination level.

Option : UV illuminometer kit



UV illuminometer

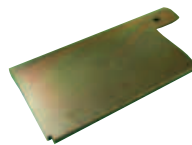

UV illuminometer BKT1

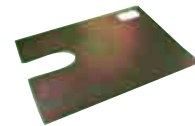

UV illuminometer BKT2



- When checking the UV illumination level, be sure to wear the supplied goggles and gloves to avoid UV light.
- Be sure to wear the long sleeve to protect skin from the UV light.

Steps to checking the level;

1. Make sure that the LOCAL mode is displayed.

<< LOCAL >>

2. Press the [FUNCTION] key.

FUNCTION

 FUNCTION
 DATA CLEAR < ENT >

3. Select the [MAINTENANCE] by pressing the [▲] or [▼] keys.



▲

▼
 FUNCTION
 MAINTENANCE < ENT >

4. Press the [ENTER] key.

ENTER

 MAINTENANCE
 LIST < ent>

5. Select the [UV LAMP] by pressing the [▲] or [▼] keys.

▲

▼
 MAINTENANCE
 UV LAMP < ent>

6. Press the [ENTER] key.

ENTER

 UV LAMP
 LEVEL CHECK < ent>

7. Select the [LEVEL CHECK] then, press the [ENTER] key.

ENTER

 UV LEVEL CHECK
 HEAD MOVE :ent

8. Move the carriage to the capping station by pressing [ENTER] key.

The carriage is moved.

ENTER

 MOVING
 PLEASE WAIT

9. Open the left maintenance cover.

PLEASE OPEN
THE LEFT COVER



10. Remove the Flashing tray and then, set the UV illuminometer.

Setting the UV illuminometer

- A. Set the UV illuminometer BKT 1 so that the bracket touches the device.

- B. Set the edge of the illumination sensor to the UV illuminator BKT 1.
Turn up the sensor hole to pass through the bracket hole. Insert the illumination sensor reliably.

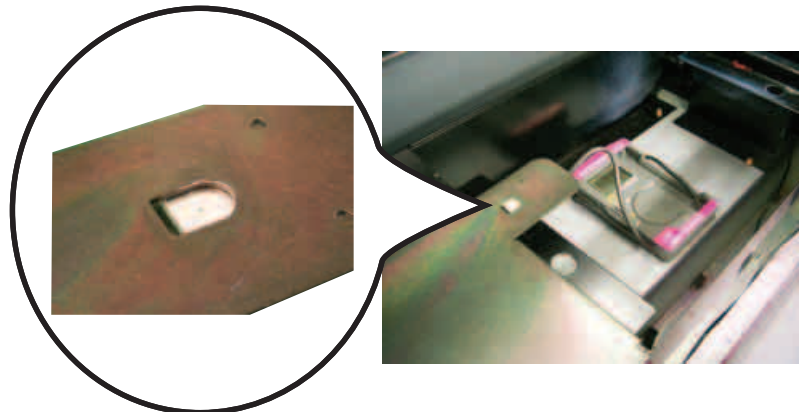
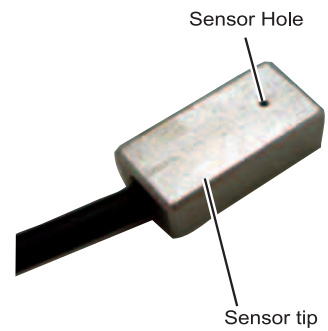
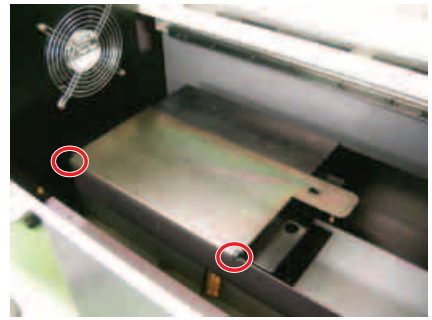

- C. Set the illuminometer switch to the [H] position.

- D. Press the left side button several times.

- E. Indicate the [DH MAX] above the number.

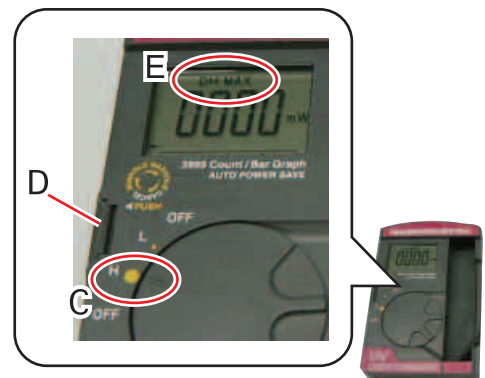

- F. Cover the illuminometer BKT 2 with matching the upper left corner and positioning the handle at upper right.

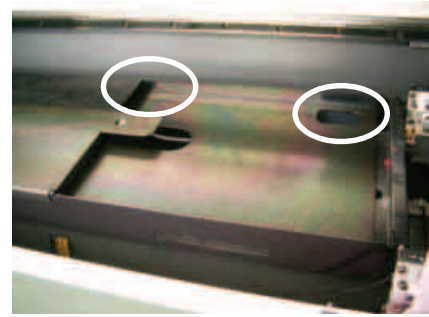

- 11. Press the [ENTER] key after setting the UV illuminometer.

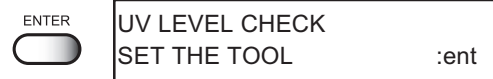

- 12. Close the left maintenance cover.

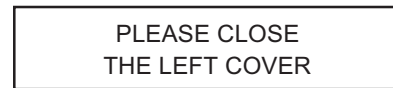

- 13. Select the intensity of UV level.

Pressing the [FUNCTION] key changes the intensity of UV level. The selected intensity of UV level is indicated at upper right of the display.
H:HIGH, N: NORMAL, L:LOW



- 14. Press the [ENTER] key and then the checking is started.



- In case the check lamp lights off, it takes time to light.

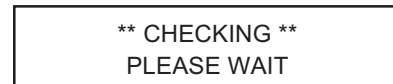

- 15. After checking, open the left maintenance cover.

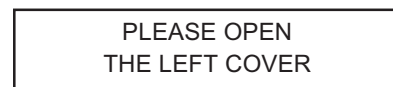

- When measuring the UV level, press the [ENTER] key to back to STEP13 before opening the maintenance cover.

- 16. Remove the UV illuminometer BKT 2 and then verify the checking level on the indicator.



- Refer to the indicator value on inside of the UV illuminometer.





- Do not touch the left side of the BKT 2 after checking to avoid burn injury.

17. After verifying the level, press the [ENTER] key.



18. Press the [▶] to terminate the illumination check. Press the [▶] key and then finish the level check.



When check the illumination again, press the [◀] and do the step E of the setting the UV illuminometer.

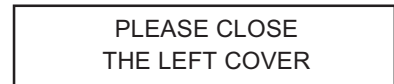
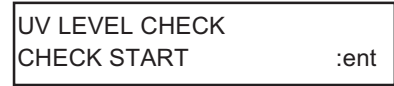

 CAUTION

- Make sure to check the level again after the lamp cools down. An accurate result can not be obtained by UV lamp heat.

19. Remove the UV illuminometer and BKT1.



- Do not touch the BKT1 and sensor parts of the UV illuminometer on or right after checking to avoid from burn injury. Make sure to remove them after it cools down completely.



20. Attach the Flashing tray and then press the [ENTER] key.



21. Close the left maintenance cover.

Detect the origin and back to LOCAL.

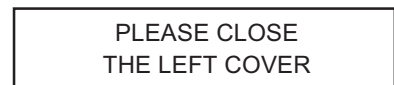

Prevent the nozzle clogging of spot color [SP.REFRESH]

To prevent the head nozzle clog, this unit performs refresh while printer is turned on. However the characteristic of white ink is different from other inks, therefore nozzle out occurs even performing the refresh. In this case change the head refresh operation, where white ink is installed, so as to suitable for the white ink. This will prevent the nozzle out.

STEPS:

1. Select the [SP.REFRESH] from the [MAINTENANCE]. (☞ P.5-2)

```
MAINTENANCE
SP.REFRESH      <ent>
```

2. Press the [ENTER] key.

```
ENTER
SPECIAL REFRESH
COLOR           :*****
```



- All the initial value of SP. REFRESH is set to OFF. Indicated as “*”.

3. Select a head to spot color refresh by pressing the [◀] and [▶] keys.

```
◀ [ENTER] ▶
SPECIAL REFRESH
COLOR           :*****
```

4. Select ON or OFF of spot color refresh execution by pressing the [▲] and [▼] keys.

```
▲ [ENTER] ▼
SPECIAL REFRESH
COLOR           :*****WS
```



- Set the head where install the white ink to ON. Indication shows “W”.
- In the case if white color is installed onto spot color, due to the ink set change, set the head to ON. Indication shows “S”.

5. Press the [ENTER] key to make effective the setting.

```
ENTER
MAINTENANCE
SP.REFRESH      <ent>
```

Displaying device information [INFORMATION]

Displays the firmware version and serial number of this device.

If trouble occurs, please inform the dealer or MIMAKI sales office of the contents of the trouble as well as this information.

STEPS:

1. Select the [INFORMATION] from the [MAINTENANCE]. (☞ P.5-2)



MAINTENANCE
INFORMATION < ent >

2. Press the [ENTER] key.



ENTER INFORMATION
VERSION < ent >

3. Press the [ENTER] key again, then select [VERSION].



ENTER MAIN Ver 1.50
I / F Ver 1.50

The firmware version is displayed.

4. Press the [ENTER] key to return to the [VERSION].



ENTER INFORMATION
VERSION < ent >

5. Select the [SERIAL NO.] by pressing the [▲] or [▼] keys.

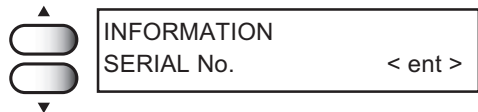

▲ INFORMATION
SERIAL No. < ent >
▼

6. Press the [ENTER] key.

The serial number is displayed.

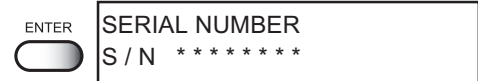

ENTER SERIAL NUMBER
S / N *****

7. Press the [ENTER] key to return to the [SERIAL NO.].

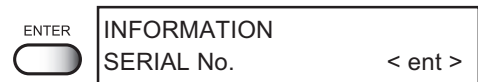

ENTER INFORMATION
SERIAL No. < ent >

8. Press the [END] key three times, the device returns to the LOCAL mode.

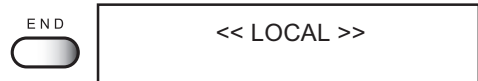

END << LOCAL >>

Set the type of the cap rubber [CAP RUBBER]

After replacing the cap rubber, set the type of the cap rubber newly attached.

STEPS:

1. Select the [CAP RUBBER] from the [MAINTENANCE]. (☞ P.5-2)



```
MAINTENANCE
CAP RUBBER      < ent >
```

2. Press the [ENTER] key.

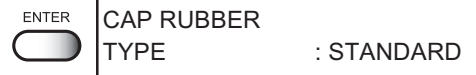

```
ENTER
CAP RUBBER
TYPE          : STANDARD
```

3. Select the type of cap rubber by pressing the [▲] or [▼] keys.

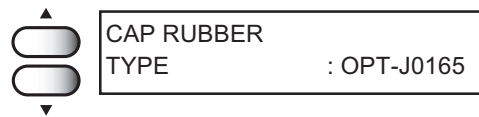

```
▲
CAP RUBBER
TYPE          : OPT-J0165
▼
```

4. Press the [ENTER] key.

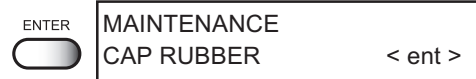

```
ENTER
MAINTENANCE
CAP RUBBER      < ent >
```

5. Press the [END] key twice, the device returns to the LOCAL mode.

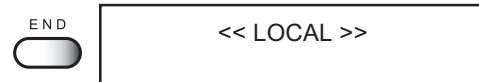

```
END
<< LOCAL >>
```

CHAPTER 6

When abnormal conditions are encountered

Chapter 6 describes corrective measures to be taken in the case where an abnormal phenomenon arises on the device and where an error message is given on the display.

Table of contents

Before taking a phenomenon as a sign of failure	6-2
If image quality declines	6-3
Troubles for which error messages are given on the LCD	6-4

Before taking a phenomenon as a sign of failure

Corrective measures against troubles in the case where no error message is given on the LCD are described in this section. Be sure to take the following measures before taking the trouble as a sign of failure. If the measures fail restore the device to the normal state, contact your local MIMAKI distributor or MIMAKI office to call for service.

The device cannot be energized

More often than not, this is due to improper connection of the power cable. Check that the power cable has been properly connected to the power outlet and the computer.

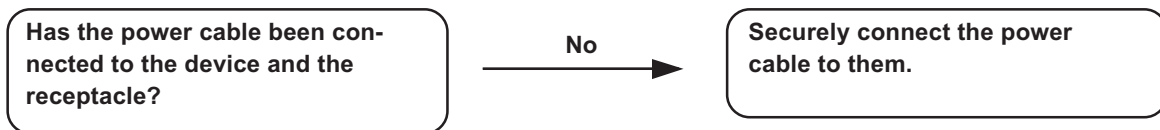

The device cannot perform printing

This occurs when the data is not being transmitted to the device properly. It can also occur when any of the device functions fails or the media has been set improperly.

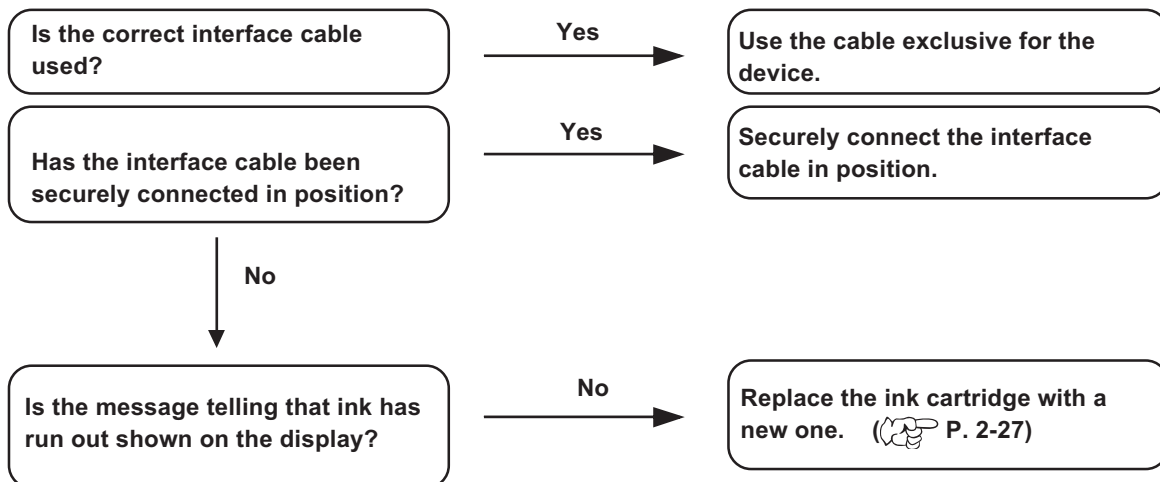

Display [WATER NOT READY] OR [UV NOT READY]

When [WATER NOT READY] appears on the display, the water temperature in the water heater has not reached the predetermined value. When [UV NOT READY] appears, the temperature of the UV lamp has not reached the predetermined value; it means the UV lamp is unavailable and printing is disabled.

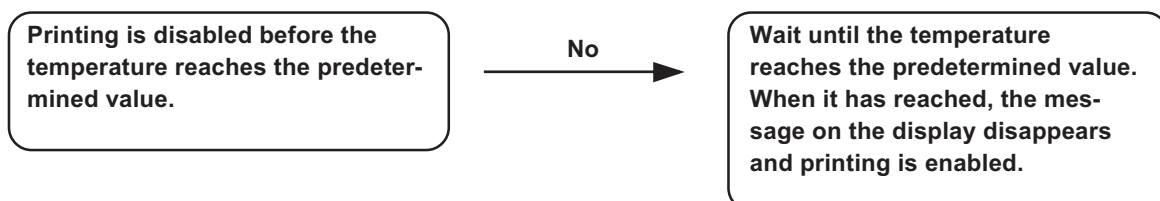

If image quality declines

Corrective measures against troubles in the case where satisfactory image quality is not provided are described in this station.

Take measures in accordance with actual state of the picture.

If the measures fail restore the device to the normal state, contact your local MIMAKI distributor or MIMAKI office call for service.

Lines/thin spots are obvious occur

Corrective measure : Execute the head cleaning. (☞ P.2-20)

Corrective measure : Clean the interior of the station. (☞ P.3-3)

Corrective measure : If slip of paper is present in the head path, for example, above the work plate, remove it.

Large ink drop on media

Corrective measure :

1. Execute the ink caps cleaning. (☞ P.3-3)
2. Execute the head cleaning [normal]. (☞ P.2-20)
3. Dust the media.
4. Dust the table.
5. Execute the cleaning for the undersurface of the carriage. (☞ P.3-16)

Media is raised during printing and printing stops.

During printing, media may be raised due to the heat from the UV lamp, causing printing to be stopped.

Corrective measure :Set new media and start printing.

Troubles for which error messages are given on the LCD

If something is wrong with the device, the buzzer sounds and a corresponding error message is given on the LCD. Take an appropriate corrective measure in accordance with the message.

Errors accompanied by warnings

Warning message	Cause	Corrective measure
! UV LAMP UV LAMP CHANGE :ent	Changing time for the UV lamp.	Contact your local distributor or to call for service to change the UV lamp.
! UV LAMP UV LEVEL CHK :ent	The UV lamp level has come to the admeasurement time.	Confirming UV lamp light level. (☞ P.5-23)
<<LOC.>> NEAR END COLOR :KCMYcmW	The amount of ink remaining in the ink cartridge is insufficient.	[REMOTE] key. However, it is recommended to replace the ink cartridge of which number is shown on the LCD with a new one.
! INK END COLOR :KCMYcmW	The ink cartridge has run out of ink.	Replace the ink cartridge of which color is shown on the LCD with a new one.
<<LOC.>> use LIMIT COLOR :KCMYcmW	The ink will expire soon or has expired.	[REMOTE] key. However, it is recommended to replace the ink of which number is shown on the LCD with a new one.
! INK CARTRIDGE COLOR :KCMYcmW	The ink cartridge is not attached to the ink station.	Attach the ink cartridge(s) corresponding with the color shown on the display.
! INK TANK WASTE TANK FULL	Waste ink tank is full.	Remove the waste ink tank and set an empty waste ink tank.
!MEDIA HEIGHT TABLE DOWN	The device has detected that the print heads and the media may come into contact with each other during the jog operation.	Down the table by pressing the [▼] key on the sub panel until the LCD indicates "OK", and then start the jog operation again. Or remove the media from the table and then press the [ENTER] key.
! WRONG CARTRIDGE COLOR :KCMYcmW	The loaded ink cartridge is defective.	Check the loaded ink cartridge.
! REINSERT CART. COLOR :KCMYcmW	Ink near end was detected right after the cartridge with much remaining amount of ink has been inserted.	Pull out the inserted cartridge and insert it again. If the same error message appears again on the LCD, contact your local distributor to call for service.

Warning message	Cause	Corrective measure
! Color of INK COLOR :KCMYcmW	The color of the loaded ink cartridge is different from the previous one.	Check the color of the loaded ink cartridge.
! Kind of INK COLOR :KCMYcmW	The type of the loaded ink cartridge is different from the previous one.	Check the type of the loaded ink cartridge.
! NonORIGINAL INK COLOR :KCMYcmW	The loaded ink cartridge is not MIMAKI genuine.	Use the ink specified by MIMAKI.
! WRNING INK IC COLOR :KCMYcmW	The IC chip of the ink cartridge cannot be read normally.	Attach the ink cartridge(s) corresponding with the color shown on the display. If the same error message appears again on the LCD, contact your local distributor to call for service.
! Expiration : 2MON COLOR :KCMYcmW	The ink has already expired.	Replace the ink cartridge of which color is shown on the LCD with a new one.
<div data-bbox="245 869 603 949" style="border: 1px solid black; padding: 2px;">! Mainte. warning WIPER TANK FULL</div> <div data-bbox="373 963 443 1030" style="text-align: center; margin: 10px 0;">  </div> <div data-bbox="245 1039 603 1115" style="border: 1px solid black; padding: 2px;">! Mainte. warning OK : <ent></div>	Wiper waste ink tank is near full.	Contact your local distributor to call for service.
! WIPER TANK FULL CALL FOR SERVICE	Wiper waste ink tank is full.	Contact your local distributor to call for service.

Error messages

Error messages indicates error numbers.

If any error message is given on the LCD, turn off the power to the device and turn it on after a while.

If the same error message appears again on the LCD, contact your local MIMAKI distributor or MIMAKI office to call for service.

Error message	Cause	Corrective measure
<div style="border: 1px solid black; padding: 2px; margin-bottom: 5px;">ERROR 01 MAIN ROM</div> <div style="border: 1px solid black; padding: 2px;">ERROR 02 MAIN RAM</div>	Control circuit board is defective.	Turn off the power to the device and turn it on after a while. If the same error message appears again on the LCD, contact your local distributor to call for service.
<div style="border: 1px solid black; padding: 2px; margin-bottom: 5px;">ERROR 03 POWER +5V</div> <div style="border: 1px solid black; padding: 2px;">ERROR 03 POWER +35V</div>	Control circuit board is defective. POWER+5V POWER+35V	
<div style="border: 1px solid black; padding: 2px; margin-bottom: 5px;">ERROR 04 FLASH SAVE</div> <div style="border: 1px solid black; padding: 2px; margin-bottom: 5px;">ERROR 05 FPGA-ss</div> <div style="border: 1px solid black; padding: 2px; margin-bottom: 5px;">ERROR 06 UHC ss nnnn</div> <div style="border: 1px solid black; padding: 2px;">ERROR 07 DFC ss</div>	Control circuit board is defective.	
<div style="border: 1px solid black; padding: 2px; margin-bottom: 5px;">ERROR 10 COMMAND</div> <div style="border: 1px solid black; padding: 2px;">ERROR 11 PARAMETER</div>	<p>The device has received data other than command data. The interface cable used is not in conformance with this printer.</p> <p>A parameter outside the range of acceptable numeric values is received. Strange color data has been received.</p>	<p>Securely connect the interface cable in position. Use an interface cable in conformance with the standard.</p> <p>Check the host computer output setting.</p>
<div style="border: 1px solid black; padding: 2px;">ERROR 12 OFF SCALE</div>	Print the data at outside range.	Check the printing range.
<div style="border: 1px solid black; padding: 2px;">ERROR 13 MEMORY DATA</div>	When each edition has different resolution or there is the same color during receiving data in the MEMORY mode, it is displayed.	In case of copying multi editions, use the data which has the same resolution and which there is not the same color in each edition.

Error message	Cause	Corrective measure
ERROR 20 I / F BOARD	Improper operation has been conducted on the operation panel.	Turn off the power to the device and turn it on after a while. If the same error message appears again on the LCD, contact your local distributor to call for service.
ERROR 23 HOST I / F	HOST I/F Timeout error has arisen during communication between the host computer and interface board.	Check to be sure that the cable is securely connected to the host computer and interface board. Also, check to ascertain that no error has arisen on the host computer side.
ERROR 24 I / F INITIAL	Initial operation failure of the I/F board and control board.	Turn off the power to the device and turn it on after a while. If the same error message appears again on the LCD, contact your local distributor to call for service.
ERROR 30 OPERATION	An error occurs on the interface between the I/F board and the control board.	Perform a proper operation.
ERROR 34 DATA REMAIN	Settings for functions have been tried to be changed though there remains received data that has not yet been printed.	Print all pieces of received data or execute the data clear function. Then, change the settings.
ERROR 35 MARK DETECT	No registration mark detected. (During copy-printing operation)	<ol style="list-style-type: none"> 1. Check whether or not the sheet is curling up. 2. Confirm the appropriate detect starting point specified. 3. Confirm the black registration mark printed against the white back-ground. 4. Confirm no dust or dirt in between the registration marks. <p>In case setting value of [DIST. REVI.] is [BEFORE], confirm no mistake on the specified length.</p> <ol style="list-style-type: none"> 5. Confirm no mistake on the registration mark settings. 6. Confirm the status and the settings described above. If still no registration mark detected, contact your distributor or us.
ERROR 36 HEAD GAP	The gap between the head and media is too narrow.	Adjust the head gap again.

Warning message	Cause	Corrective measure	
ERROR 40 MOTOR X	The X motor has been overload.	Turn off the power to the device and turn it on after a while. If the same error message appears again on the LCD, contact your local distributor to call for service.	
ERROR 41 MOTOR Y	The Y motor has been overload.		
ERROR 42 X CURRENT	Overcurrent error on the X motor has been detected.		
ERROR 43 Y CURRENT	Overcurrent error on the Y motor has been detected.		
ERROR 44 SCAN RANGE	Out of scanning is occurred.		
ERROR 50 X ORIGIN	X origin could not be detected.		
ERROR 51 Y ORIGIN	Y origin could not be detected.		
ERROR 52 TABLE HEIGHT SENSOR	Table height sensor could not be detected.		
ERROR 53 STEP MOTOR ORIGIN	Step motor origin could not be detected.		
ERROR 60 FLASHING nnnn	Flashing action time out error has been occurred.		
ERROR 61 TEMP ss	Head temperature is abnormal condition.	Make sure to check the water volume. (☞ P.3-8)	
ERROR 70 WATER LACK	Water volume is shortage.		
ERROR 71 WATER DEVICE ss	Hot water device error has been occurred.		Turn off the power to the device and turn it on after a while. If the same error message appears again on the LCD, contact your local distributor to call for service.
ERROR 72 UV POWER OFF	The UV device power is off when the device started.		
ERROR 73 UV DEVICE SS	The UV device error has been occurred.		
ERROR 74 UV DEVICE	The UV device abnormal signals has been occurred.		
ERROR 90 F/W ss	Firmware is defective.		

Appendix

This appendix describes the specifications and components the device, function menu structure.

Table of contents

Basic specifications	A-2
Specification for ink	A-3
Position of the warning label	A-4
Function flowchart	A-7

Basic specifications

Item		UJF-605C
Printing head	Method	Piezo-electric drop-on demand
	Specification	Max 8-heads Inlines
	Resolution	300, 600, 1200 and 2400dpi
Drawing mode	300 x 300 dpi	2 passes:Unidirection, 4 / 8 passes : Unidirection and high speed
	600 x 600 dpi	4/8 passes:Unidirection, 16 passes : Unidirection and high speed
	1200 x 1200 dpi	8 passes:Unidirection, 16/32 passes : Unidirection and high speed
	1200 x 2400 dpi	16 passes:Unidirection, 32 passes : Unidirection and high speed
Usable inks		7 color UV curing inks (Black, Cyan, Magenta, Yellow, Light Cyan, Light Magenta, 6 colors and White)
Delivery system of ink		Supplies ink through a tube from ink cartridge Remaining ink display function (IC mounted) Ink end detecting function
Capacity of ink cartridge		440 cc per cartridge
Usable media	Size	700 x 600mm
	Thickness	Less than 50mm
Media type		Polyester film, Polycarbonate, OPP
Max. printing		600mm x 500mm
Distance accuracy	Absolute accuracy	± 0.1 mm
	Reproducibility	± 0.2 mm
Perpendicularity		± 0.5 mm / 1000 mm
Head height adjustment		Automatic head gap adjustment enabled. The media surface is sensed with the area sensor, moving up or down the table.
Media vacuum		Absorption of media by blower vacuum
UV unit		UV irradiation device incorporated, UV power
Waste ink tank		Bottle type (2,000 cc [1pcs.], with full tank sensor)
Interface	Host	IEEE1394 compliant, IEEE1284 compliant
	Table	Bi-direction port x 4
Command		MRL-II B (ESC/PV.2 base, MIMAKI original command)
Noise		during standby : Less than 55 dB (FAST-A, Front & Rear & Left & Right 1 m) during continuous printing : Less than 65 dB during discontinuous printing : Less than 70 dB
Safety Standard		UL, VCCI-Class A, FCC-Class A, CE Marking, CB Report
Ink safety		MSDS
Power (Main and Uv unit)		AC 200 ~ 240 V
Power consumption		4.0k VA or less Main device : 0.5kVA, UV device : 1.8kVA, Heater : 1kVA, Blower:0.7kVA
Recommended Environment	Available temp.	15 °C to 30 °C (59 to 86°F)
	Humidity	35 to 65 % Rh (No condensation)
	Guaranteed temp.	18 °C to 25 °C (64 to 77°F)
	Temperature change	± 10 °C (50°F) / h or less
	Dust	Equivalent to normal office level

Item		UJF-605C
Weight	Packing box	Approx. 420 kg
Outside dimensions	Width	2250 mm
	Depth	1570 mm or less
	Height	1370 mm or less
Laser sensor (Laser Sensor Unit)		Class II Laser Product Maximum output : 3mW Pulse Duration : 3.5µs Wave length : 650nm Laser medium : A/Ga/nP

Specification for ink

Item	Specifications
Color	Black ink cartridge
	Cyan ink cartridge
	Magenta ink cartridge
	Yellow ink cartridge
	Light cyan ink cartridge
	Light magenta ink cartridge
	White ink cartridge
Contents of ink	440 cc per cartridge
Shelf life	One year from the data of manufacture (at room temperature) Within three months after opening the package
Storage temperature	During storage : 15 to 35°C (59 to 95°F)
	During shipping: 0 to 60°C (0 to 140°F) within 2 weeks permitted











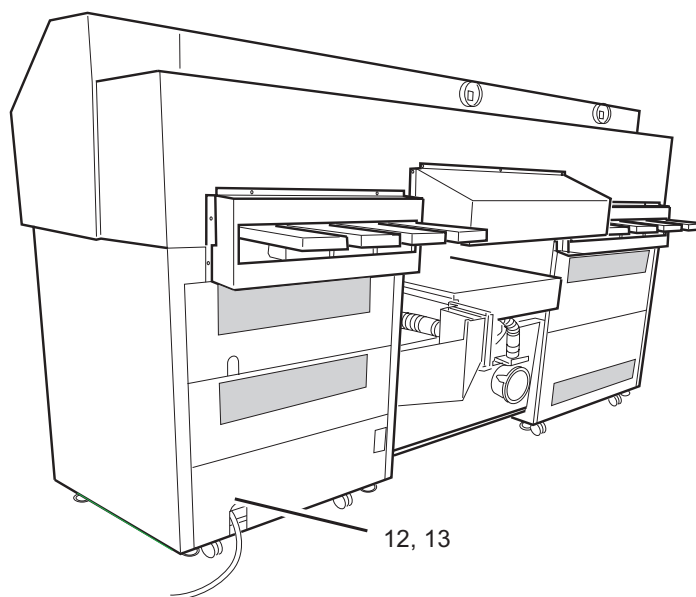
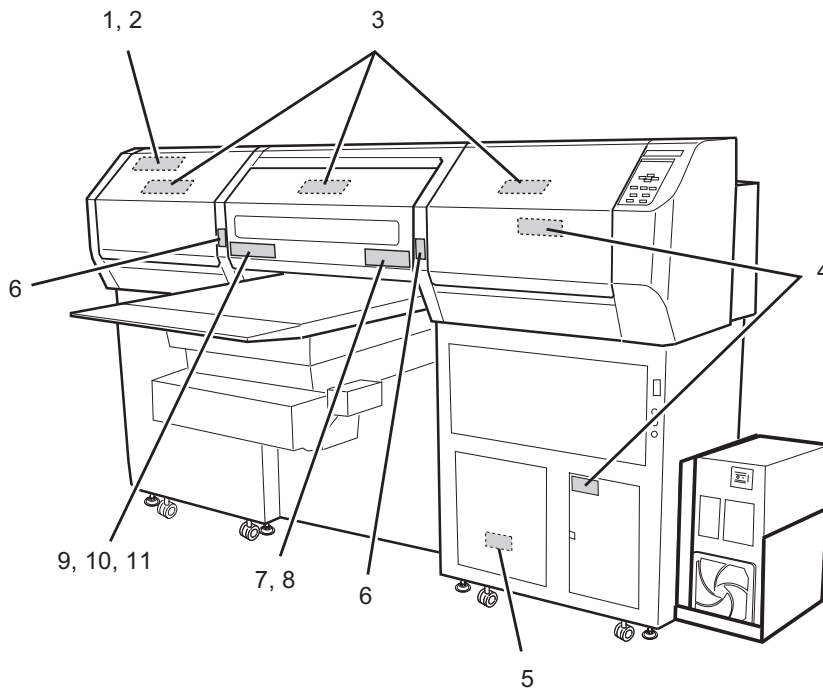



- The ink will freeze when it is left in the cold for a long time. Should it freeze, leave the ink cartridge at room temperature (at 25°C [77°F]) for three hours or more to allow the ink to melt.
- Disassembling the ink cartridge or refilling the ink shall be avoided.

Position of the warning label

This device is adhered with the warning label. Be sure to fully understand the warning given on the labels.

In the case where any of the warning label has become so soiled that the warning message is illegible or has come off, purchase a new one from your local distributor or our office.

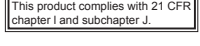

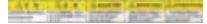
No.	Reorder No.	Reorder No.	No.	ReorderNo.	Reorder No.
1	M903764		8	M901607	
2	M903763		9	M903747	
3	M903946		10	M904131	
4	M903330		11	M904148	
5	M963239		12	M904130	
6	M904152		11	M902396	
7	M901549				

Function flowchart

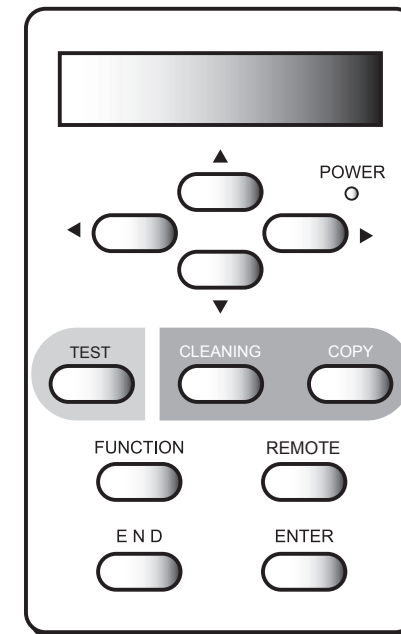
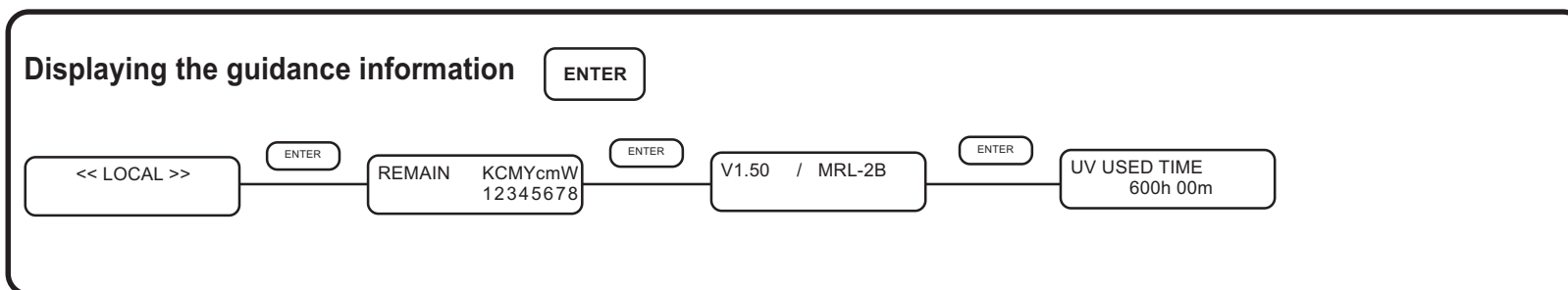
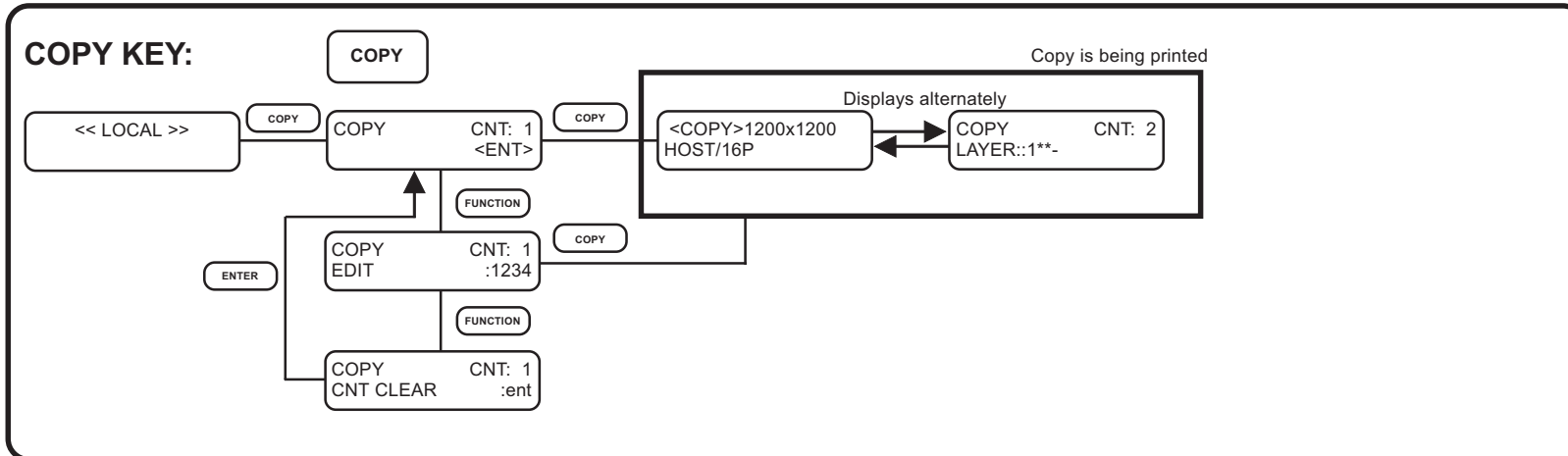
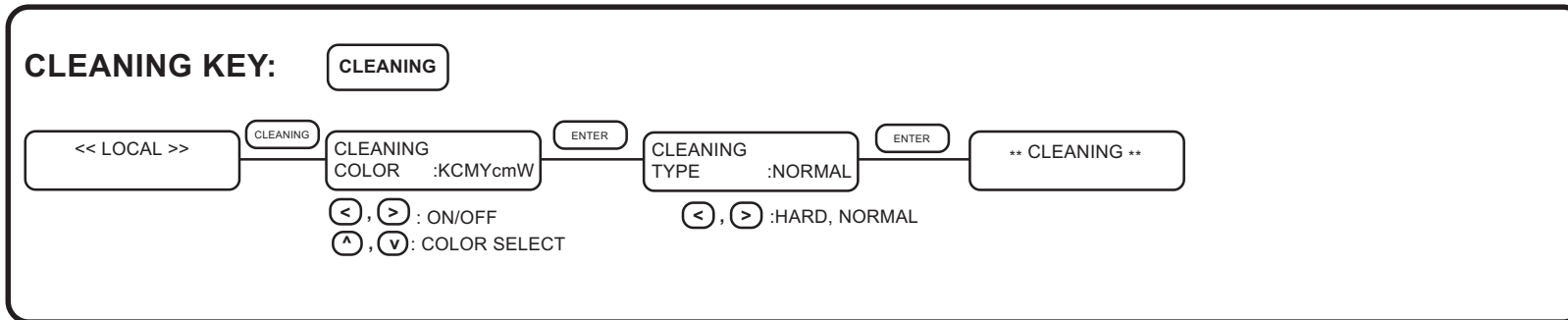
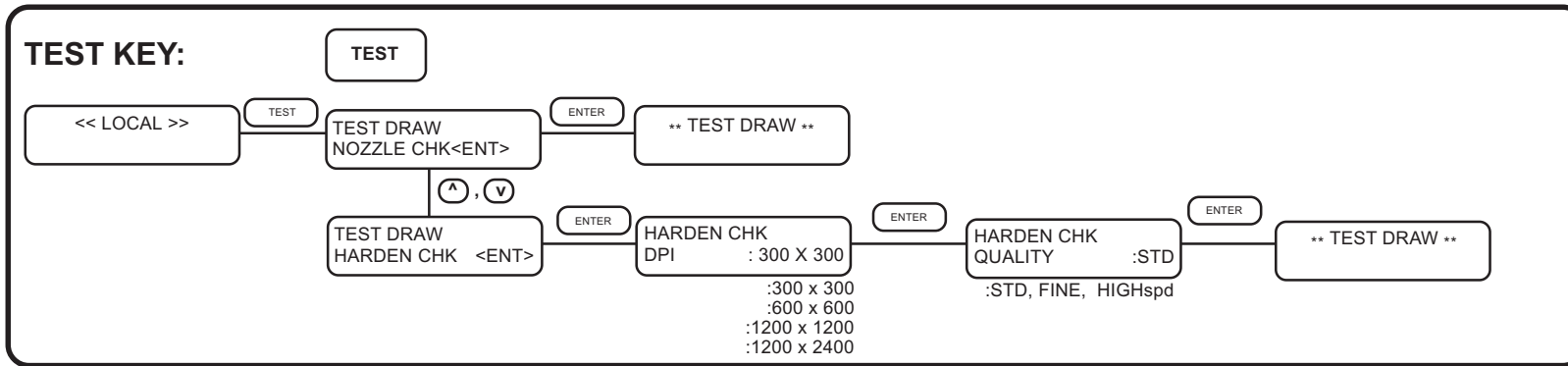

FUNCTION KEY:

FUNCTION

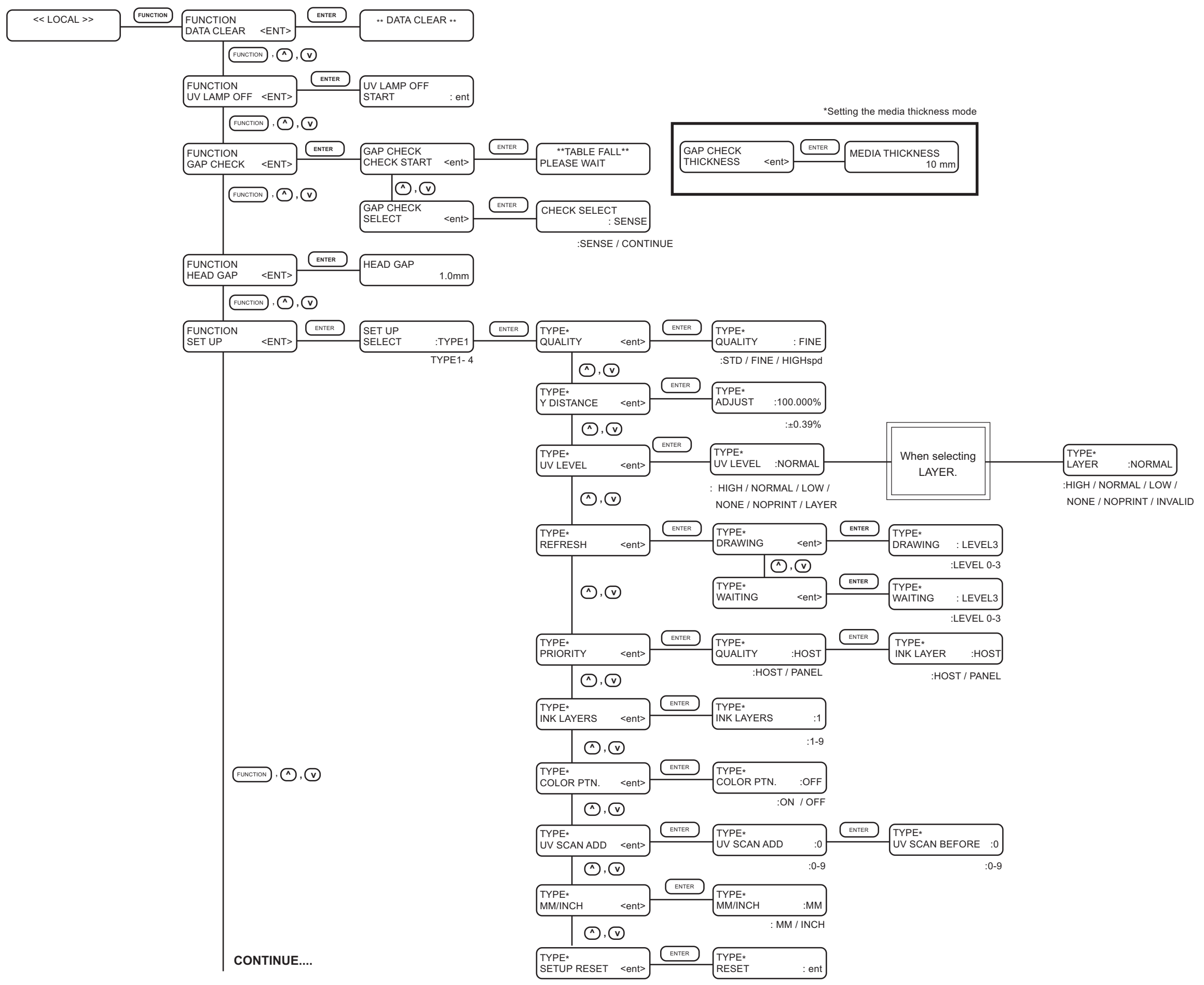

CONTINUE....

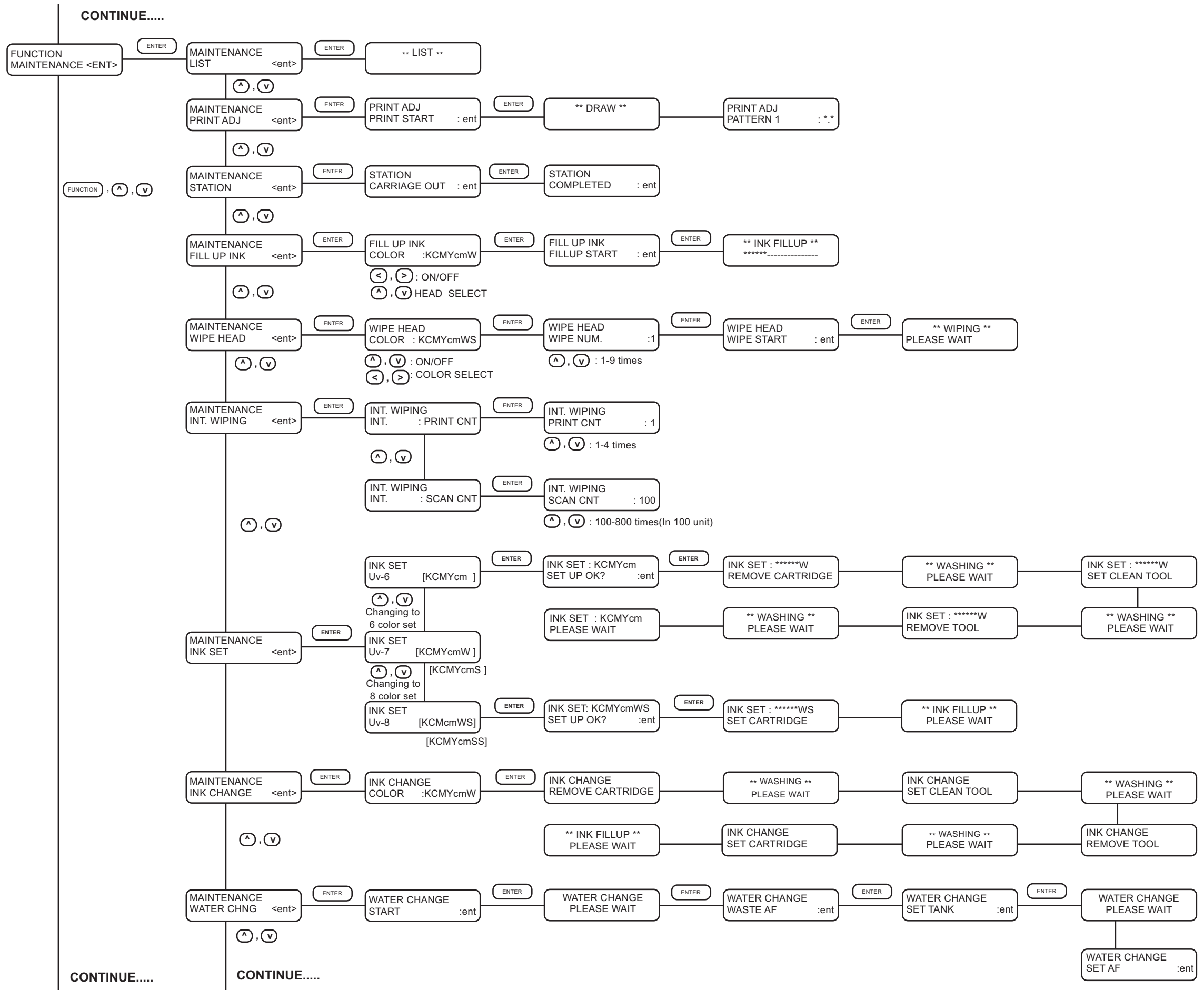

CONTINUE.....

