

Software RIP

RasterLink 6 PLUS

Installation Guide

MIMAKI ENGINEERING CO., LTD.

<https://mimaki.com/>

D203210-22

Table of Contents

Precautions	4
About this guide	5
Notation used in this guide	5
Symbols used in this guide	5
How to obtain this manual and related manuals	5

Chapter 1 About RasterLink6Plus

1.1 Introduction	8
System Configuration	8
1.2 Product specifications and system requirements	9
Product specifications	9
System requirements	10

Chapter 2 RasterLink6Plus Setup

2.1 How the setup procedure goes	14
2.2 Pre-installation setup	15
2.3 RasterLink6Plus installation	16
Installation procedure	17
2.4 License activation	18
Where you can find the serial key	18
When the RasterLinkPC has Internet access	19
When the RasterLinkPC has no Internet access	20
2.5 Profile installation	26
Installation procedure from the profile update	26
Installation procedure from the Profile Manager	28
2.6 Initial RasterLink6Plus startup	30
Initial startup procedure	30
Printer registration procedure	31
2.7 RasterLink6Plus version upgrade	35
Version upgrade through the program update	35
Version upgrade with a CD	36
Download of the update tool from the official website	36

Chapter 3 RasterLink6Plus enhancements

3.1 Installation and version upgrade of RasterLinkTools	38
3.2 CuttingLink installation	39
System requirements	39
Installation procedure	39

Chapter 4 RasterLink6Plus uninstallation

4.1 Uninstallation procedure	42
4.2 How to deactivate the license	43
When the RasterLinkPC has Internet access	43
When the RasterLinkPC has no Internet access	44
4.3 Uninstallation procedure	49

Chapter 5 Troubleshooting related to license activation

5.1 Troubleshooting by case example	52
If, without deactivating the license, you have	52
If you replaced the PC without deactivating the license	52
If you cannot use the software because an error message appears when running [Program Update] or [Profile Update] after the PC was sent for repair.....	52
If you lost the serial key	52
5.2 How to deactivate the license if the PC fails.....	54

Precautions

- Any unauthorized use or reproduction, in part or whole, of this manual is strictly prohibited.
- The information in this manual may be subject to change without notice in the future.
- Note that some of the descriptions in this manual may differ from the actual specifications due to improvements and revisions to this software.
- Copying Mimaki Engineering Co. Ltd. software described in this manual to other disks (except for the purpose of backup) or loading it to memory other than for the purpose of running it, is strictly prohibited.
- With the exception of what is provided in the warranty provisions, Mimaki Engineering Co. Ltd. does not assume any liability for any damage (including, but not limited to, the loss of profit, indirect damage, special damage, or other monetary damages) resulting from the use or inability to use this product. The same shall also apply to cases where Mimaki Engineering Co. Ltd. has been advised of the possibility of damage in advance. For example, we shall not be liable for any loss of media (work) caused by use of this product or indirect losses caused by products created using the media.

RasterLink is a trademark or a registered trademark of Mimaki Engineering Co. Ltd. in Japan and other countries.

Adobe, the Adobe logo, Acrobat, Illustrator, Photoshop, and PostScript are the trademarks or registered trademarks of Adobe Inc. in the United States and other countries.

Apple, Macintosh, Mac OS X, and macOS are registered trademarks of Apple Inc.

Microsoft, Windows, Windows 7, Windows 8.1, Windows 10, and Windows 11 are registered trademarks or trademarks of Microsoft Corporation in the United States and other countries.

Other company names and product names described in this manual are trademarks or registered trademarks of their respective companies.



About this guide

This manual describes all of the settings required to install RasterLink6Plus.

Notation used in this guide

- The buttons and items displayed in screens are enclosed in square brackets [], such as [Finish] or [Full Color].
- Replace a printer name with the name of the product you are using.
- A PC in which RasterLink6Plus is installed is referred to as "RasterLinkPC".

Symbols used in this guide

Description		
	Important	The "Important" symbol represents information you must be familiar with when using RasterLink6Plus.
	Tip	The "Tip" symbol represents useful information to know.
	Reference Information	Indicates a reference page with related information. Click on the lettering to display the corresponding page.

How to obtain this manual and related manuals

The latest version of this manual is available for download at our official site.

Other manuals for RasterLink6Plus are available as electronic data in PDF format at:

- Manual CD that comes with the RasterLink6Plus product
- Mimaki official site (<https://mimaki.com/download/software.html>)

Chapter 1 About RasterLink6Plus



This chapter

This section provides an overview of RasterLink6Plus.

Introduction.....	8	Product specifications and system requirements	
System Configuration.....	8	9
		Product specifications	9
		System requirements	10

1.1 Introduction

Thank you for purchasing this Mimaki product.

RasterLink6Plus is application software used for reading various types of image data and sending it as print data to an inkjet printer manufactured by Mimaki Engineering.

System Configuration

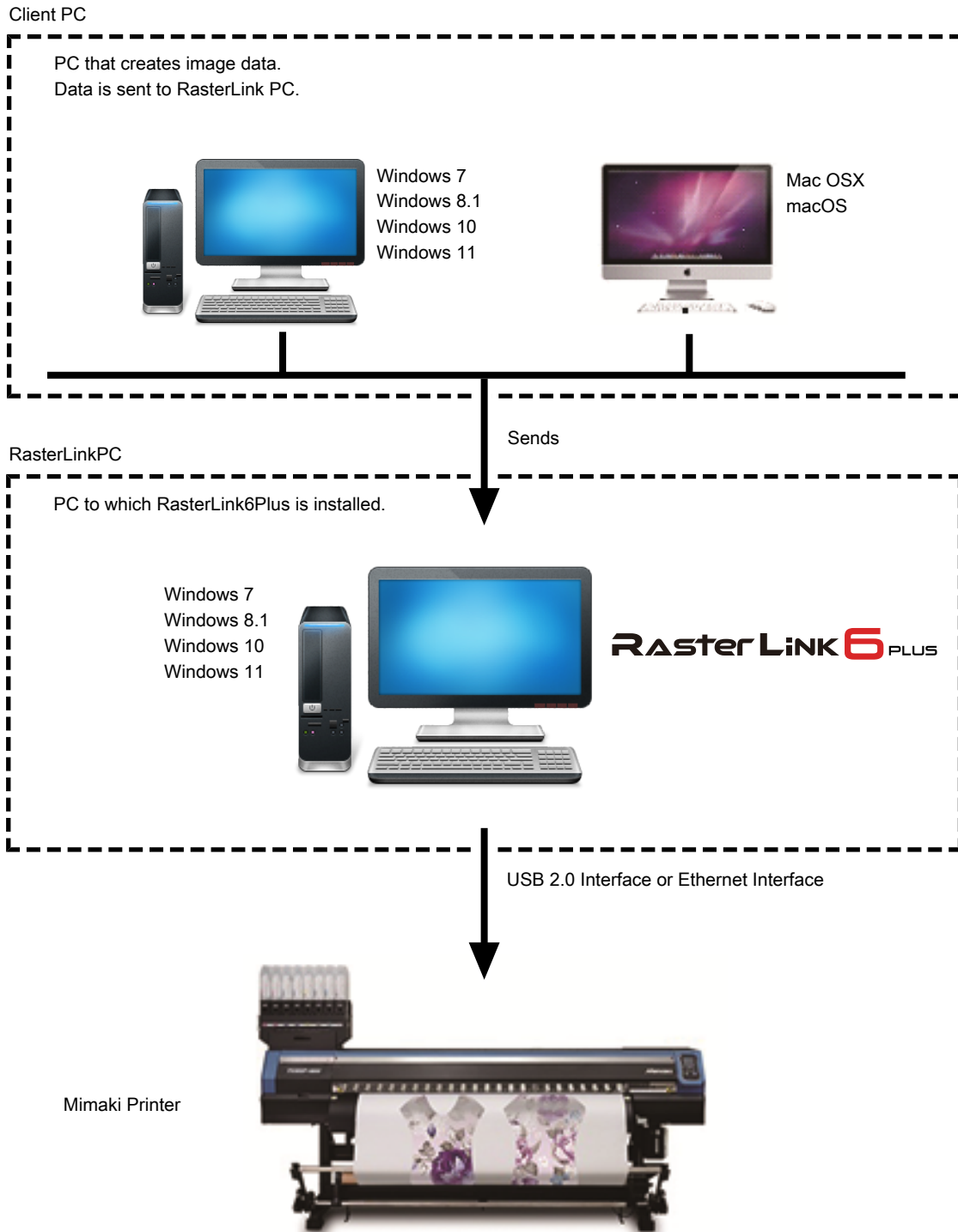

1.2 Product specifications and system requirements

Product specifications

Supported printers

RasterLink6Plus supports MIMAKI ENGINEERING ink-jet printers.
You can connect to up to 4 printers at the same time.

Input/output print data

Input data format	PostScript (PS file), EPS, TIFF, JPEG, BMP, PDF (PDF1.7 enabled ^{*1}) <ul style="list-style-type: none"> • AI is not supported. • The alpha channel is not available in TIFF data.
Design application	Adobe Illustrator 8, 9, 10, CS or later Adobe Photoshop 5, 6, 7, CS or later
PostScript font	Standard 60 European fonts A font cannot be added.
Maximum spoolable image size	Width: 10871 mm, Length: 10871 mm
Maximum spoolable file size	2GB
Maximum RIP-processible image size ^{*2}	Width: 60 m, Length: 100 m

*1. - The PDF versions correspond to the following Acrobat versions:

PDF1.3: Acrobat 4

PDF1.4: Acrobat 5

PDF1.5: Acrobat 6

PDF1.6: Acrobat 7

PDF1.7: Acrobat 8 or later

- Any PDF file that is saved by Illustrator is not supported.

- The following PDF functions are not supported:

PDF1.4 or later: Transparency

PDF1.5 or later: Layer, embedded movies, embedded Flash movies, password locking

PDF1.6 or later: : 3D, JDF

*2. Depending on how you create print data, the software may fail to produce a raster image even in the image size listed above. If this happens, create the data differently or use application software to print divided data.

If you use special color ink (such as white ink), the maximum size in the width direction may be limited depending on the resolution. Refer to the "maximum drawing range" that is described in the instruction manual of your printer.

System requirements

RasterLink6Plus installation PC

OS	Microsoft® Windows 7® Home Premium Service Pack1 or later (32-bit/64-bit version) Microsoft® Windows 7® Professional Service Pack1 or later (32-bit/64-bit version) Microsoft® Windows 7® Ultimate Service Pack1 or later (32-bit/64-bit version) Microsoft® Windows 7® Enterprise Service Pack1 or later (32-bit/64-bit version) Microsoft® Windows 8.1® (32-bit/64-bit version) Microsoft® Windows 8.1® Pro (32-bit/64-bit version) Microsoft® Windows 8.1® Enterprise (32-bit/64-bit version) Microsoft® Windows 10® Home (32-bit/64-bit version) Microsoft® Windows 10® Pro (32-bit/64-bit version) Microsoft® Windows 10® Enterprise (32-bit/64-bit version) Microsoft® Windows 11® Home Microsoft® Windows 11® Pro
----	---

● Minimum required system

At least a PC with the following specifications is required to use RasterLink6Plus:

CPU	Intel® Core2 Duo 1.8GHz or higher* ¹
Chip set	Intel genuine chip set* ¹
Memory	2GB or more
Disk space	Free space of 100 GB or more (NTFS format)
Interface	Ethernet port* ² , USB1.1/2.0* ³

● Recommended system

OS	Windows 10® Pro 64bit
CPU	Intel® Core™ i5-4670K (3.4GHz)
Chip set	Intel® Z87 Express
Memory	8GB
Disk space	500 GB
Interface	Ethernet port* ² , USB1.1/2.0* ³

*1. Use an Intel CPU and an Intel chip set. Otherwise, an error may occur during printing, causing the printer to stop printing.

*2. It is required for license activation. (It is still required even if the system has no Internet access or a PPP-connected network device is used.)
(For Ethernet-connection-enabled printers only) An Ethernet port is required to connect the printer. Use a PC that supports 1000BASE-T (Gigabit). For details, refer to the Important section below.

*3. A USB2.0 port is required to connect to a printer. Do not use a USB hub and an extension cable when connecting to the printer. An error may occur during printing, causing the printer to stop printing.
(For dongle-version products only) A USB1.1 or USB2.0 port is required to attach the USB dongle. Do not attach the dongle via a USB hub.

Important! To print over the network, you need to have the environment below. Communication may be unstable even in a gigabit-capable PC with a CAT5e cable. Make sure you use a CAT6 or higher cable.

- PC: The LAN port supports the 1000BASE-T (gigabit) mode.
- Cable: It is the CAT6 or higher cable.
- Hub (if used): It supports the 1000BASE-T (gigabit) connection.



- For the latest information, visit our official website (<https://mimaki.com/>).

● Limitations on printing via network

- The system is not available over a wireless LAN or on a PLC.
- The system is not available on a VPN.
- When used with a wireless LAN, the system may not be able to connect to a printer. In this case, disable the wireless LAN.
- The RasterLinkPC is available only when it is on the same segment as the printer.
- If the network experiences high load during data transfer to the printer (for example, downloading a video at the same time), the sufficient transfer rate may not be achieved.

Client PC

The client PC can use one of the OSs listed in the table below.

Depending on the OS of the RasterLinkPC, however, some client PCs cannot be connected or can be connected but their functionality is limited.

For details about the connection with the client PC, refer to the "Network Connection Guide" in the manual CD or at our official website.

● OS for Windows Client PCs

OS	Microsoft® Windows 7® Home Premium Service Pack1 or later (32-bit/64-bit version) Microsoft® Windows 7® Professional Service Pack1 or later (32-bit/64-bit version) Microsoft® Windows 7® Ultimate Service Pack1 or later (32-bit/64-bit version) Microsoft® Windows 7® Enterprise Service Pack1 or later (32-bit/64-bit version) Microsoft® Windows 8.1® (32-bit/64-bit version) Microsoft® Windows 8.1® Pro (32-bit/64-bit version) Microsoft® Windows 8.1® Enterprise (32-bit/64-bit version) Microsoft® Windows 10® Home (32-bit/64-bit version) Microsoft® Windows 10® Pro (32-bit/64-bit version) Microsoft® Windows 10® Enterprise (32-bit/64-bit version) Microsoft® Windows 11® Home Microsoft® Windows 11® Pro
----	---

● OS for Macintosh Client PCs

OS	Mac OS X 10.3.9 to 10.11 macOS 10.12 to 13
----	---

Chapter 2 RasterLink6Plus Setup



This chapter

This chapter explains the installation procedure of RasterLink6Plus and the required setup tasks.

How the setup procedure goes	14	Profile installation	26
Pre-installation setup	15	Installation procedure from the profile update	26
RasterLink6Plus installation	16	Installation procedure from the Profile Manager	28
Installation procedure	17	Initial RasterLink6Plus startup	30
License activation	18	Initial startup procedure	30
Where you can find the serial key	18	Printer registration procedure	31
When the RasterLinkPC has Internet access	19	RasterLink6Plus version upgrade	35
When the RasterLinkPC has no Internet access	20	Version upgrade through the program update	35
		Version upgrade with a CD	36
		Download of the update tool from the official website	36

2.1 How the setup procedure goes

1. Pre-installation setup

["Pre-installation setup"\(P. 15\)](#)

- Install the Mimaki driver.
The Mimaki driver is required to connect to a printer.
- Change the Windows Update settings.
- Turn off the sleep setting.

2. RasterLink6Plus installation

["RasterLink6Plus installation"\(P. 16\)](#)

- Insert the installation CD into the PC to install RasterLink6Plus.
RasterLink6Plus can also be downloaded from our official site.

3. License activation

["License activation"\(P. 18\)](#)

- Activate your license.

4. Profile installation

["Profile installation"\(P. 26\)](#)

- Install a profile that is suitable for your printer and ink.

5. Initial RasterLink6Plus startup

["Initial RasterLink6Plus startup"\(P. 30\)](#)

- Register a printer or printers.

6. RasterLink6Plus version upgrade

["RasterLink6Plus version upgrade"\(P. 35\)](#)

- Update your RasterLink6Plus to the latest version.

7. Network setup

- Configure the network settings, if required.
(Refer to the "Network Connection Guide" in the manual CD or at our official website)
The Hot Folder and Printer Driver functions of the RasterLink6Plus enable you to read images from other PCs via networks.

2.2 Pre-installation setup

Before installing RasterLink6Plus, do the following:

1 Install the Mimaki driver.

The Mimaki driver is provided in the following two ways:

- Driver CD that comes with our printer
- Our official website (<https://mimaki.com/>)

2 Check the Automatic update settings of Windows Update.

- If the PC is restarted while RasterLink6Plus is running, you may no longer start RasterLink6Plus later.

Configure the following settings so that the PC is not restarted while RasterLink6Plus is running:

• In Windows 8.1/Windows 7

If [Automatic update] is set to [Automatic] in Windows Update, update programs are installed automatically when the specified time arrives, possibly causing the PC to be restarted.

Change the update setting in Windows Update to [Download updates but let me choose whether to install them], so that the PC is not restarted automatically.

You can change the setting by selecting:

[Control Panel] - [System and Security] - [Windows Update] - [Enable or Disable Automatic Updates]

• In Windows 10

- (1) Configure Windows Update to pause updates, so that the PC is not restarted automatically.

You can change the setting by selecting:

[Settings] - [Update and Security] - [Windows Update] - [Advanced Options] - [Pause Updates]

- (2) Specify the active hours, so that the PC is not restarted during the active hours. You can change the setting by selecting:

[Settings] - [Update and Security] - [Windows Update] - [Change Active Hours] - [Active Hours]

• In Windows 11

- (1) Configure Windows Update to pause updates, so that the PC is not restarted automatically.

You can change the setting by selecting:

[Settings] - [Windows Update] - [Pause Updates]

- (2) Specify the active hours, so that the PC is not restarted during the active hours. You can change the setting by selecting:

[Settings] - [Windows Update] - [Advanced Options] - [Active Hours]

3 Turn off the sleep setting.

- If the PC is configured to sleep (hibernate) automatically, it may go to sleep even when RasterLink6Plus is performing processing. In this case, the processing and printing will stop and the system for RasterLink6Plus may be corrupted.

You can change the setting by selecting:

[Control Panel] - [System and Security] - [Power Options] - [Change when the computer sleeps] and setting [Put the computer to sleep] to [Never]

4 Check if our other software RIPs are installed in the PC.

- If RasterLinkPro5 is installed, you can install RasterLink6Plus without uninstalling it. However, you cannot use RasterLinkPro5 while RasterLink6Plus is running.



- Keep the version of your RasterLinkPro5 up-to-date. If you use 2.70 or earlier version, the software may malfunction.

- If you find any of RasterLinkPro to RasterLinkPro4 installed, uninstall it.

2.3 RasterLink6Plus installation



- Install RasterLink6Plus as a user with the Administrator authority.

When you insert the RasterLink6Plus installation CD into the CD-ROM drive, the RasterLink6Plus installation menu appears automatically.

RasterLink6Plus If the installation menu does not appear automatically, then double-click "CDMenu.exe" in the CD-ROM.



If the [User Account Control] screen appears before the installation menu opens, then click [Yes] to show the installation screen.

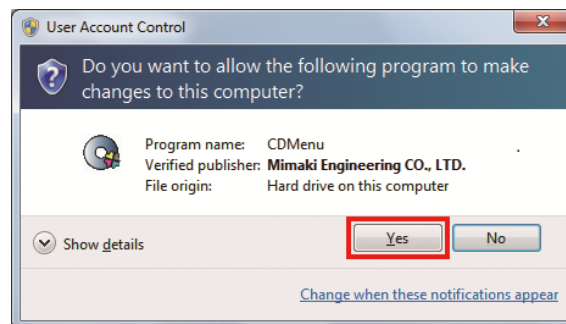

You can also obtain an installer from an official site.

- You can also download and install the installer from our official website (<https://mimaki.com/>).

Installation procedure

1 In the installation menu, click [Install RasterLink6Plus].

- The installation confirmation screen for the USB dongle driver appears.



- Double-click the installer when you download the installer from the official site.

2 Click [OK].

- The installation of the USB dongle driver is started.
- The [Choose Setup Language] dialog box appears.



- If Microsoft .NET Framework is not installed, the installer for .NET Framework is started. Install .NET Framework first.

3 Select the language of your choice during installation, and click [OK].

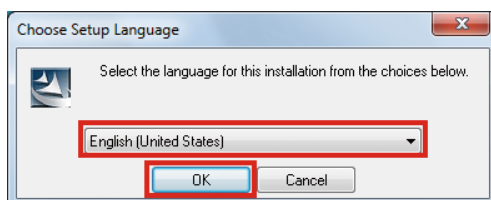

4 Click [Next].

5 Select [I accept the terms in the license agreement.] and click [Next].

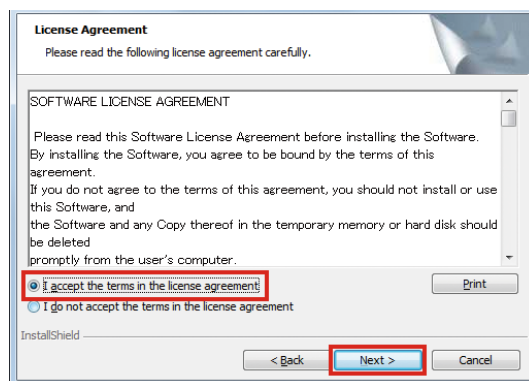

6 Specify an installation destination and click [Next]

- Specify a drive with the sufficient free space.

7 Click [Install].

- The installation is performed.

8 When the installation of RasterLink6Plus finishes, click [Finish].

9 Click [Yes].

- The PC is restarted.



- After RasterLink6Plus is installed, never remove any folders or files from the installation folder or rename any of them.

2.4 License activation

If you want to use RasterLink6Plus continuously, you need to activate your license.

For license activation, the RasterLinkPC has to connect to the Internet.

(If the PC has no Internet access, you can use another PC that has Internet access for activation.)

The license activation process uses the information from Ethernet equipment as hardware configuration information of the PC.

- Do not disable the Ethernet equipment that is enabled upon license activation.
If you switch between wired and wireless connections, keep the equipment that has been used so far active.
- If you use a PPP-connected or USB-connected network device, enable Ethernet equipment.

Important!

- In license activation, the serial key and the information to identify the RasterLinkPC (which is generated automatically from the PC hardware configuration information) are sent to Mimaki Engineering.
- You can use the software without activating the license for 60 days from the first startup, which is a trial period.
If you do not activate the license during the trial period, you can no longer use RasterLink6Plus after the period ends.
- The program update and the profile update are not available before the license is activated.
☞ ["Version upgrade through the program update"\(P. 35\)](#)
☞ ["Installation procedure from the profile update"\(P. 26\)](#)
Also, the version upgrade through the update tool, which is provided at the download page of the official website, is not available.

Where you can find the serial key

You can find the serial key at the inside of the lid for the package.

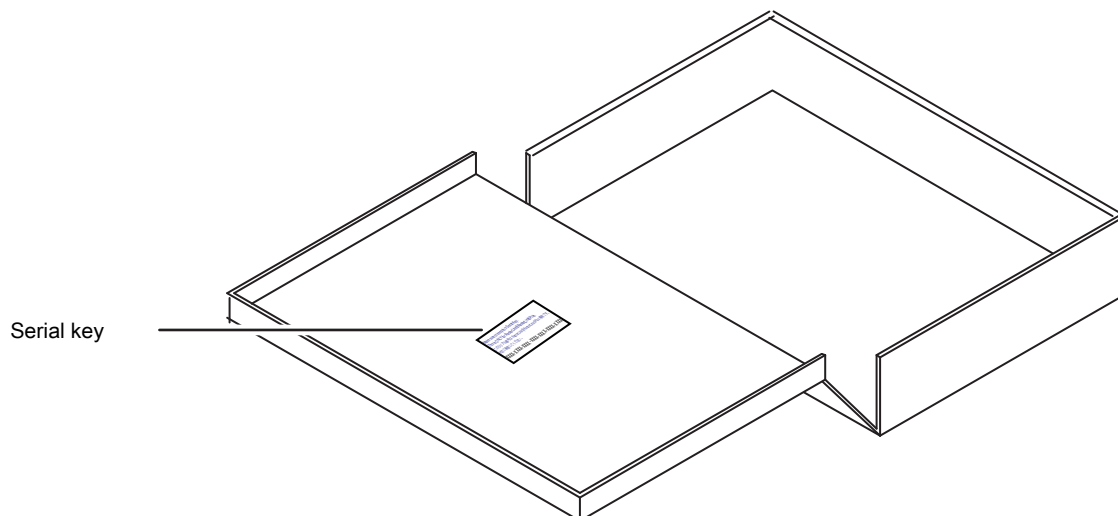

When the RasterLinkPC has Internet access

1 Start the license activation screen.

- **In Windows 7**
From the [Start] menu, select [All programs] - [Mimaki RasterLink6Plus] - [License] - [License].
- **In Windows 8.1**
At the bottom-left corner of the start screen, click the [Arrow] icon and select [Mimaki RasterLink6Plus] - [License].
- **In Windows 10 and 11**
From the [Start] menu, select [All apps] - [Mimaki RasterLink6Plus] - [License].

2 Select [Activate] and then click [Next].

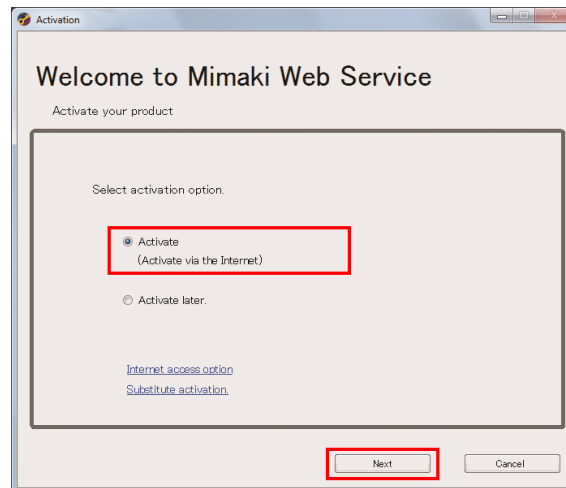

- If you are using a proxy server, then click [Internet access option] and configure the settings.

3 Enter the serial key and click [Next].

- The activation process is started.
- When the license is activated successfully, the process is completed.

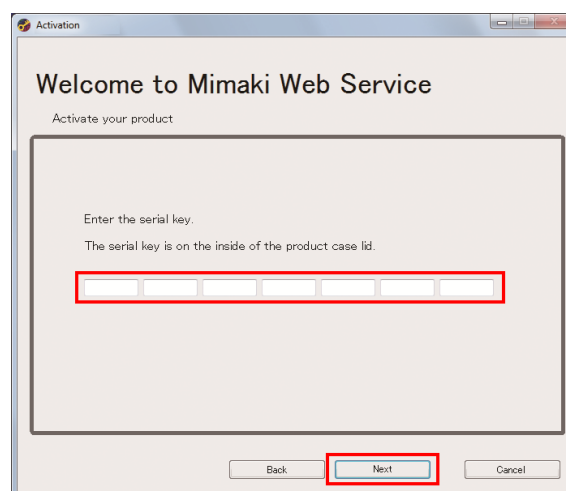

- If you are using a personal firewall, a connection confirmation screen may appear. In this case, allow the connection.

When the RasterLinkPC has no Internet access

If the RasterLinkPC has no Internet access, follow the steps below to activate the license:

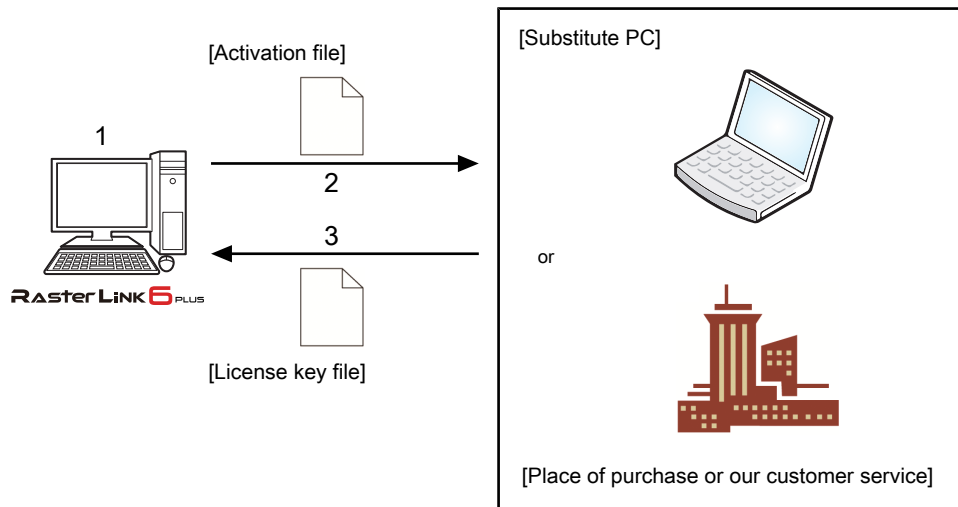

1 Create an activation file.

- Use RasterLink6Plus to create an activation file.
☞ ["Creating the activation file"\(P. 21\)](#)

2 Copy the activation file.

- If you have a PC with Internet access, copy the activation file to the PC and activate the license.
☞ ["Steps on the substitute PC"\(P. 23\)](#)
- If you do not have an environment with Internet access, you can send the activation file to us or a distributor for the purpose of license activation.
When you activate the license, a license key file is created or sent. Copy the file to any location in the RasterLinkPC.

3 Load the activation file.

- On the RasterLinkPC, load the license key file and register the license key in RasterLink6Plus.
☞ ["Loading the license key file"\(P. 24\)](#)

Creating the activation file

- 1 Use step 1 in  "When the RasterLinkPC has Internet access"(P. 19) to open the [Activation] screen and click [Substitute activation.].

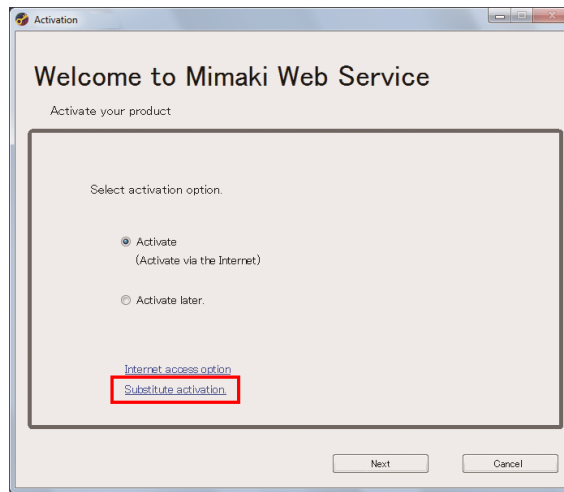

- 2 Select [Create an activation file for substitute activation.].

- (1) Click [Browse].
 - The [Save As] dialog box appears.
- (2) Specify a storage location.
- (3) Enter the name of the file to be saved, and click [Save].

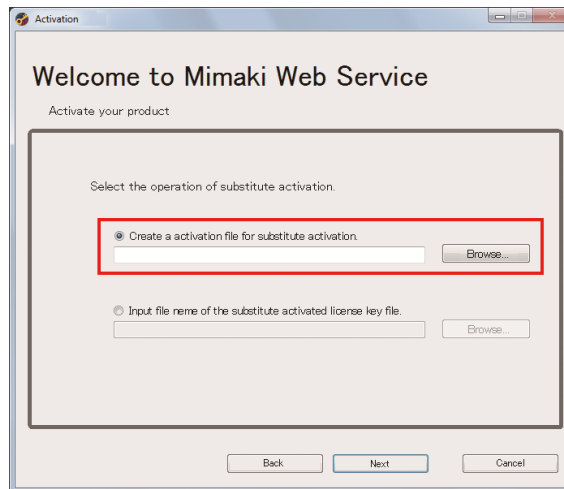

3 Click [Next].

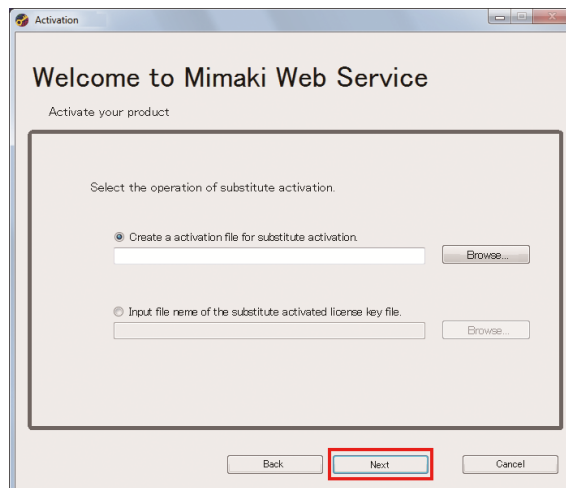

4 Enter the serial key and click [Next].

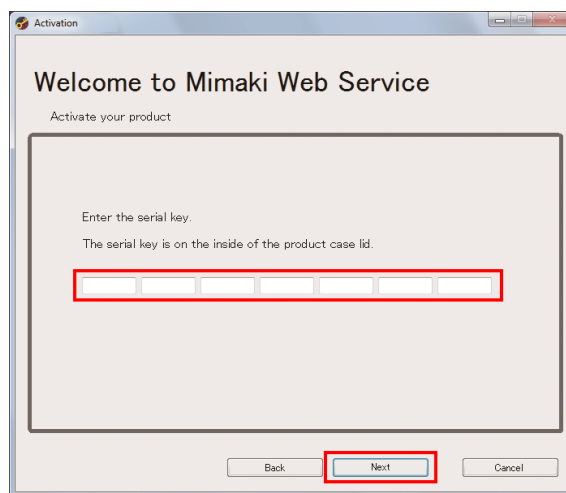

5 Click [Finish].

- The steps on the RasterLinkPC are done here.
- If you activate the license by using a substitute PC, then copy the activation file to the substitute PC.
- If you want to ask the distributor or us to activate the license, contact the relevant customer service department.



Steps on the substitute PC

1 Start the web browser and enter the following URL.

- <http://miws.mimaki.jp/license/agencytop.aspx>
- The license activation page appears.

2 Click [Activation].

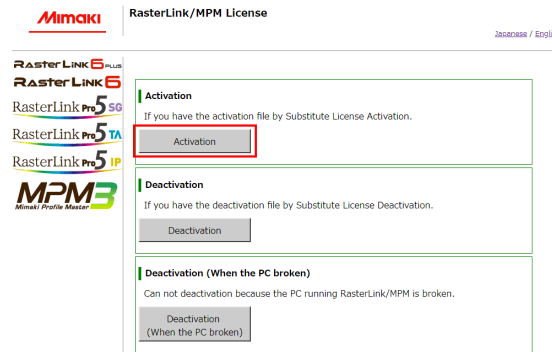

3 Click [Browse].

- In the [Open the file] dialog box that appears, specify the activation file that you saved in the RasterLinkPC.



4 Click [Get license key].

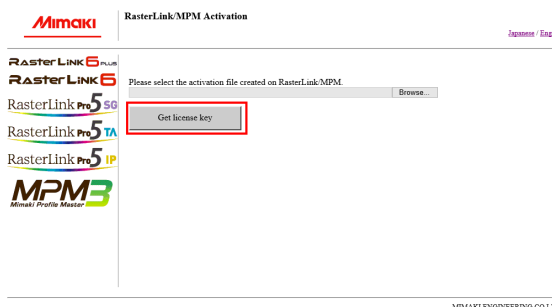

5 In the [File Download] dialog box that appears, click [Save].



6 In the [Save as] dialog box that appears, enter any name and then click [Save].

- The license key file is issued and downloaded.

7 Copy the license key file you saved to any location in the RasterLinkPC.

- Use it in  "Loading the license key file"(P. 24).

Loading the license key file

- 1 In the RasterLinkPC again, open the license activation screen and click [Substitute activation.].

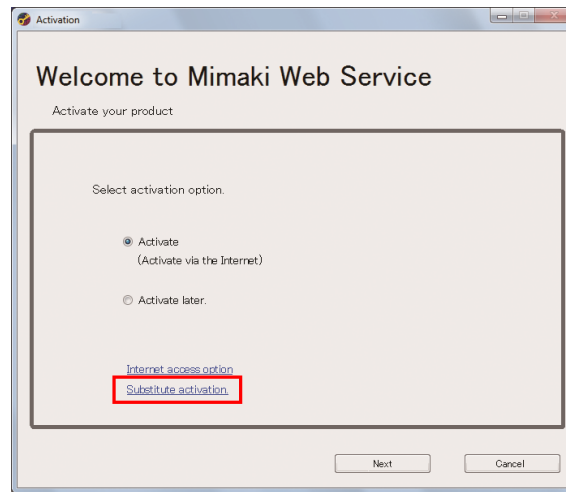

- 2 Select [Input file name of the substitute activated license key file.] and click [Browse].
 - The [Open the license key file] dialog box appears.

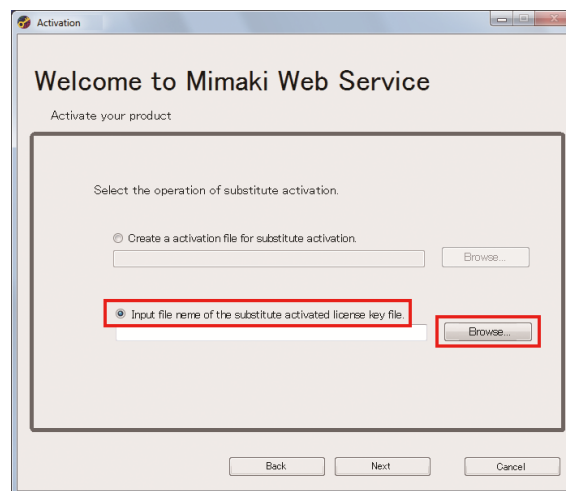

- 3 Specify the license key file and click [Next].

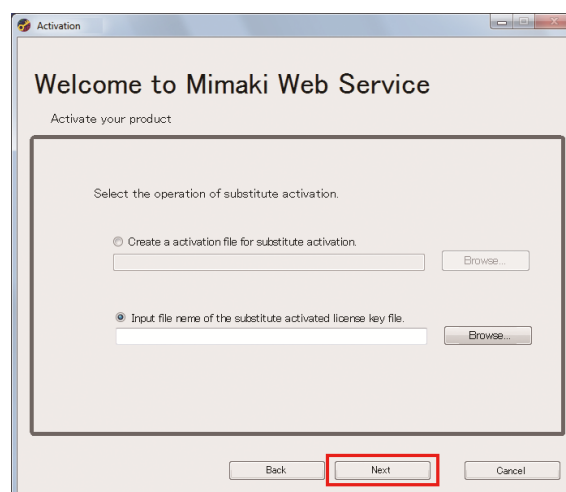

4 Click [Finish].

- The activation is finished.



2.5 Profile installation

The following profiles are required to use RasterLink6Plus.

- Device profile
- Input RGB profile
- Input CMYK profile



- For the input RGB and input CMYK profiles, standard profiles are installed automatically during RasterLink6Plus installation.

You need to install the device profile by yourself. You can install it in the following two ways:

- ["Installation procedure from the profile update"\(P. 26\)](#)
- ["Installation procedure from the Profile Manager"\(P. 28\)](#)



- For details about the profile, refer to the accompanying "RasterLink6Plus Reference Guide" in the manual CD or at our official website.

Installation procedure from the profile update

You can install the device profile by using the update tool.



- Make sure the RasterLinkPC has Internet access.
- The profile update is not available before the license is activated.

1 Start [Profile Update].

- In Windows 7
From the [Start] menu, select [Mimaki RasterLink6Plus] - [Update] - [Profile Update].
- In Windows 8.1
At the bottom-left corner of the start screen, click the [Arrow] icon and select [Mimaki RasterLink6Plus] - [Profile Update].
- In Windows 10 and 11
From the [Start] menu, select [All apps] - [Mimaki RasterLink6Plus] - [Profile Update].

2 Click [Next].

3 Specify the model and ink of the profile you want to install, and click [Next].

- Selecting the [Show only registered printer] check box shows the registered printers only. Clearing the check box shows all the printers available in RasterLink6Plus that have been installed.

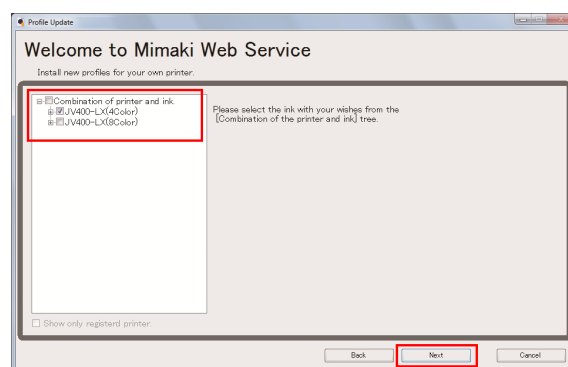

4 Specify the search options and click [Next].

- If the profiles that meet the criteria are found, the information of those profiles are listed.

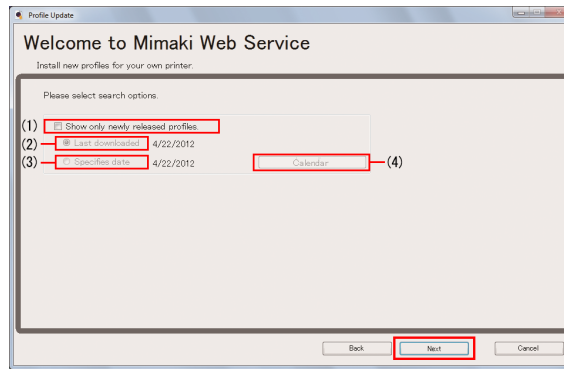

Search options

(1)	Show only newly released profiles.	Checks the profiles that were released on and after the specified date.
(2)	Last downloaded	Checks profiles that were released on and after the previous check date.
(3)	Specifies date	Checks the profiles that were released on the specified date.
(4)	Calendar	Clicking it shows a calendar. You select [Specifies date] from the calendar.



- If you are using a personal firewall, a connection confirmation screen may appear. When the screen appears, allow the connection.

5 Select the desired profile and click [Next].

- The download of the profile is started.
- Selecting the [Do not show installed profile.] check box does not show the profiles that have already been installed.

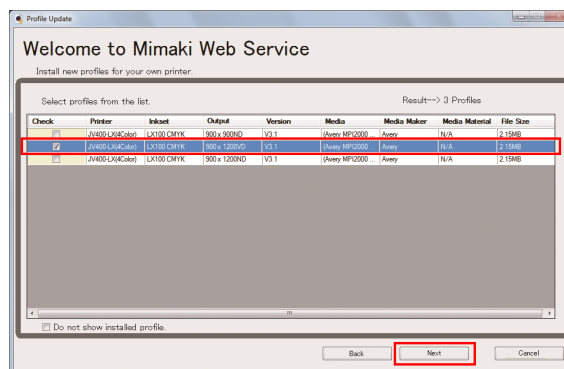

6 Click [Finish].

- The download of the profile is finished.
- The profile is installed when you start RasterLink6Plus.

Installation procedure from the Profile Manager

The Profile Manager is a tool to install or uninstall device profiles and input profiles.

You can get the device profile installed by the Profile Manager by:

- Downloading it from our official website (<https://mimaki.com/>)
- Creating it with MimakiProfileMaster3 (which is sold separately)

Starting the Profile Manager

- In Windows 7
From the [Start] menu, select [Mimaki RasterLink6Plus] - [Profile Manager].
- In Windows 8.1
At the bottom-left corner of the start screen, click the [Arrow] icon and select [Mimaki RasterLink6Plus] - [Profile Manager].
- In Windows 10 and 11
From the [Start] menu, select [All apps] - [Mimaki RasterLink6Plus] - [Profile Manager].

Installing the device profile

1 From the [File] menu, select [Install device profiles].

- Alternatively, in the toolbar, click .

2 Select the folder for the device profiles you install, and click [OK].

- The device profiles in the selected folder are listed at the upper section of the window.

3 Select the profiles you want to install and click [Down].

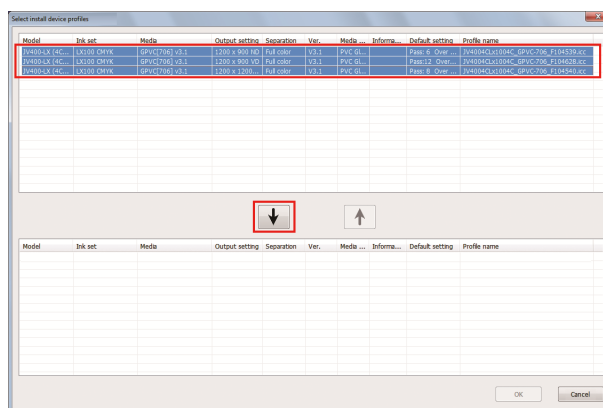

4 Click [OK].

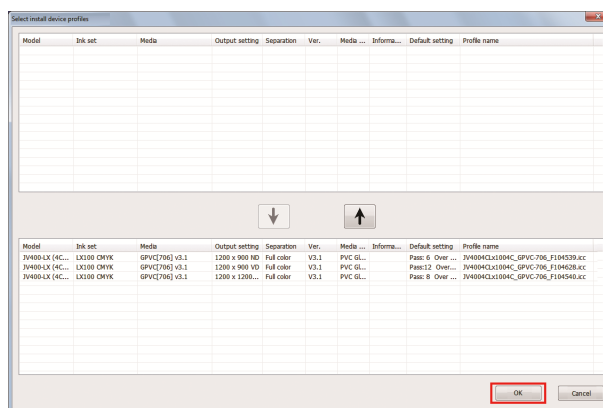

Installing the input profile

When you install RasterLink6Plus, the input profiles Mimaki Engineering provides are installed automatically. If you use a different input profile, then install it in the following way:

1 From the [File] menu, select [Install input profiles].

- Alternatively, in the toolbar, click .

2 Select the folder for the input profiles you want to install, and click [OK].

- The input profiles in the selected folder are listed at the upper section of the window.

3 Select the profiles you want to install and click [Down].

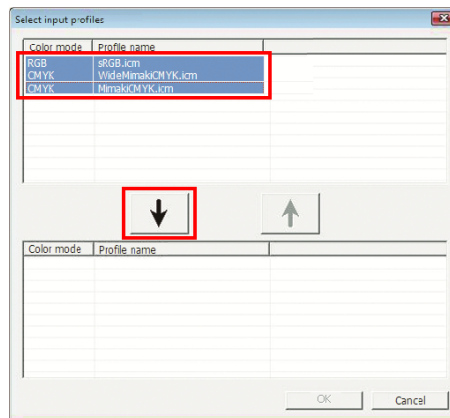

4 Click [OK].

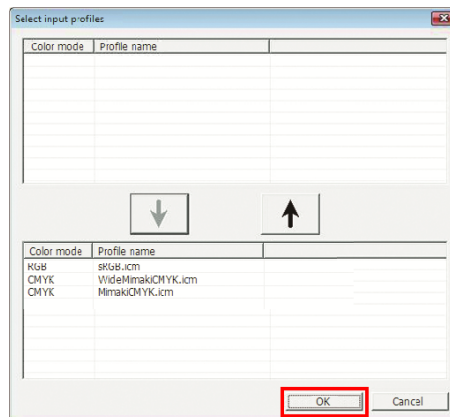

2.6 Initial RasterLink6Plus startup

Initial startup procedure

1 On the desktop, double-click the [Mimaki RasterLink6Plus] icon .

- The [User Account Control] screen appears.



If you want to start RasterLink6Plus from the start menu, do the following:

- In Windows 7
From the [Start] menu, select [Mimaki RasterLink6Plus] - [Mimaki RasterLink6Plus].
- In Windows 8.1
At the bottom-left corner of the start screen, click the [Arrow] icon and select [Mimaki RasterLink6Plus] - [Mimaki RasterLink6Plus].
- In Windows 10 and 11
From the [Start] menu, select [All apps] - [Mimaki RasterLink6Plus] - [Mimaki RasterLink6Plus].

2 Click [Yes].

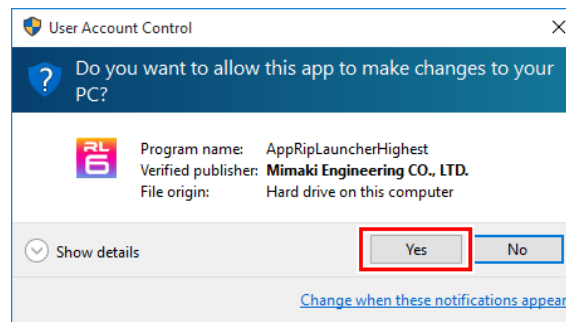

- If you see the symbol (shield) of the security center on the icon, executing the file shows the [User Account Control] screen. You then need to give authority to execute the file.

3 In [Look In], select the working folder and then click [Choose].

- The folder to store working files for the job is created automatically under the selected folder.
- RasterLink6Plus is started.

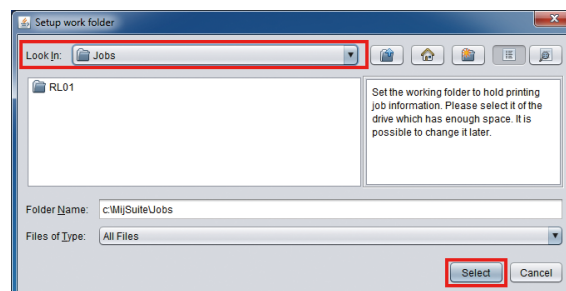

- Select the folder in a disk with sufficient free space.

Printer registration procedure

No printer is registered right after RasterLink6Plus is installed. You can use the [Printer Management] function to register the printers you use.

Important!

- Before registering any printer, select [Control Panel] - [System and Security] - [Administrative Tools] - [Service] in Windows and enable [Windows Firewall] (which means the firewall is running). If [Windows Firewall] is set to disabled, you cannot register any printers.

- 1** Turn on the printer you use, and check that the RasterLinkPC is connected with the printer through a USB 2.0 cable or a LAN cable.
- 2** In the [Printer Management] screen that appears when you start RasterLink6Plus, if no printer is registered, click [Add].

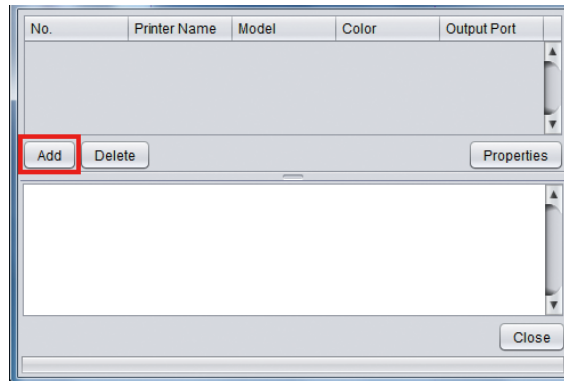

3 Configure the settings in the order specified in the following figure and table, according to the printer to be connected:

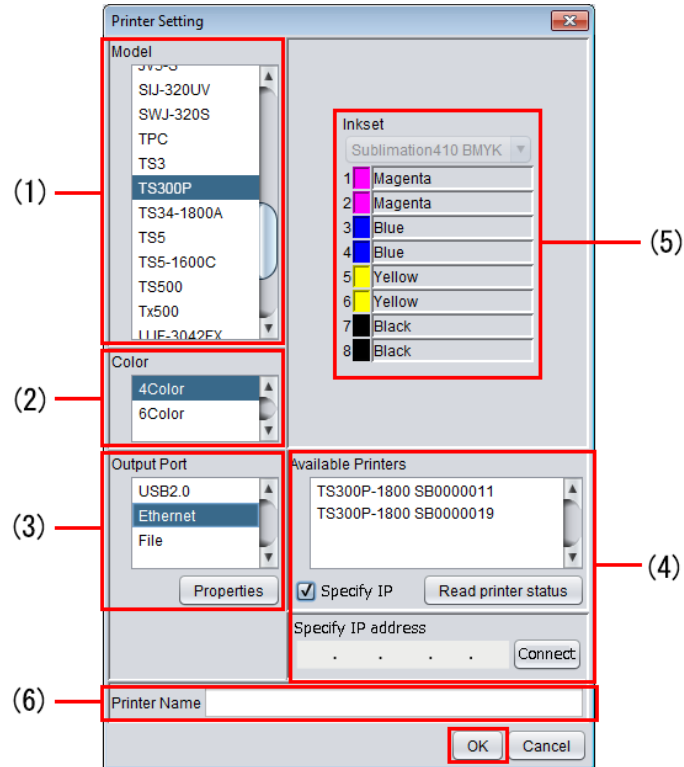

(1)	Model	Select the printer you want to register. <ul style="list-style-type: none"> You may see two [Model] values for the same series, like JV33 and JV33-260. In general, select the series name of the connected printer (for example, JV33). For printers in the same series with different features due to the print width (for example, JV33-260), select the [Model] value with the print width in mind.
(2)	Color	Specify the number of colors available in the printer. If the printer has only one color setting, the list shows nothing. The available color settings are listed below. Depending on the printers, some color settings that are not listed below are displayed. Consult the instruction manual of the printer and check the settings when the printer is installed, and then select the setting. <ul style="list-style-type: none"> 4Color: Only CMYK (BMYK) is available. 6Color: In addition to CMYK (BMYK), an ink set with up to 2 colors is available. 8Color: In addition to CMYK (BMYK), an ink set with up to 4 colors is available. 4Color+2: In addition to CMYK (BMYK), 2 spot colors are available. 6Color+2: In addition to CMYK (BMYK), 2 spot colors and up to 2 colors are available.
(3)	Output Port	If the PC is connected with the printer through a USB2.0 cable, then select [USB2.0]. If it is connected through a LAN cable, then select [Ethernet].
(4)	Available Printers	A list of printers that are connected to the PC (as serial numbers of the printers or [MACHINE NAME] values specified in the panel) is displayed. Select the printer you want to register. If the connected printer is not displayed, click [Read printer status]. If it is not still visible, check the following: <ul style="list-style-type: none"> Is the PC connected with the printer? Is the printer turned on? Is the Mimaki driver installed?  "Pre-installation setup"(P. 15)
(5)	Ink set	The information is retrieved automatically from the printer and the ink sets are selected.
(6)	Printer Name	The name is used as a printer tab name in the main window. Enter identifiable names if several printers are to be registered. This name is also used for the names of the hot folder and printer driver.

4 Click [OK].

- Important!** • If the device profile that supports the selected printer, color, and ink set is not installed, the printer cannot be registered. Install the device profile.
 ["Profile installation"\(P. 26\)](#)

5 Click [Yes].

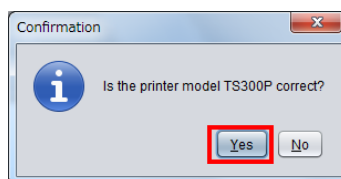

- 6** The [Do you create the hot folder and printer driver?] message appears. If you want to create a hot folder and printer driver that support the registered printer, click [Yes].

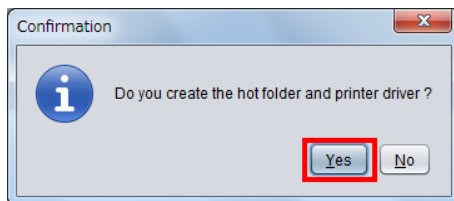

Important!

- If you have no particular reason, then click [Yes] to create the hot folder and the printer driver. (Even if you click [No] here, you can create the hot folder and the printer driver later.)
- For details about the hot folder and the printer driver, refer to the accompanying "RasterLink6Plus Reference Guide" and "RasterLink6Plus Network Connection Guide" in the manual CD or at our official website.

- 7** When you finish the process to add the printer, the [Completed.] message appears in the information display area. Click [Close].

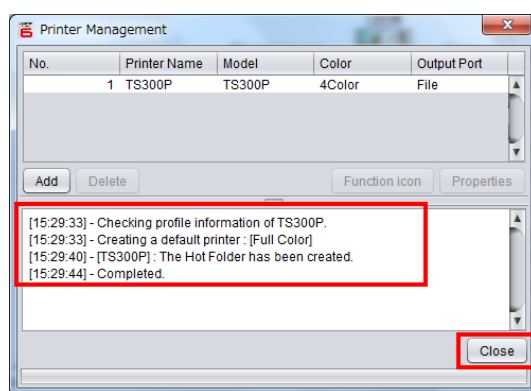

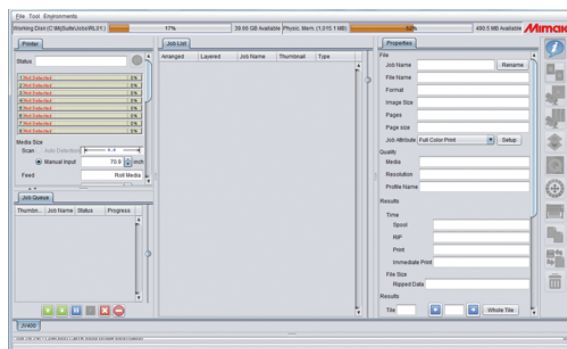

- The RasterLink6Plus main window appears.



2.7 RasterLink6Plus version upgrade

You can update RasterLink6Plus to the latest version in the following three ways:

-  "Version upgrade through the program update"(P. 35)
-  "Version upgrade with a CD"(P. 36)
-  "Download of the update tool from the official website"(P. 36)

Version upgrade through the program update

You run [Program Update] from the RasterLink6Plus program menu.

Important!

- Make sure the RasterLinkPC has Internet access.
- [Program Update] is not available before the license is activated.

1 Start [Program Update].

- In Windows 7
From the [Start] menu, select [Mimaki RasterLink6Plus] - [Update] - [Program Update].
- In Windows 8.1
At the bottom-left corner of the start screen, click the [Arrow] icon and select [Mimaki RasterLink6Plus] - [Program Update].
- In Windows 10 and 11
From the [Start] menu, select [All apps] - [Mimaki RasterLink6Plus] - [Program Update].

2 Click [Next].

3 Connect to the Internet and check if there are any updaters available.

Important!

- If you are using a personal firewall, a connection confirmation screen may appear. In this case, allow the connection.
- If available updaters are found, the list of them appears.

4 Select the updater you want to apply and click [Next].

- The updater is downloaded.

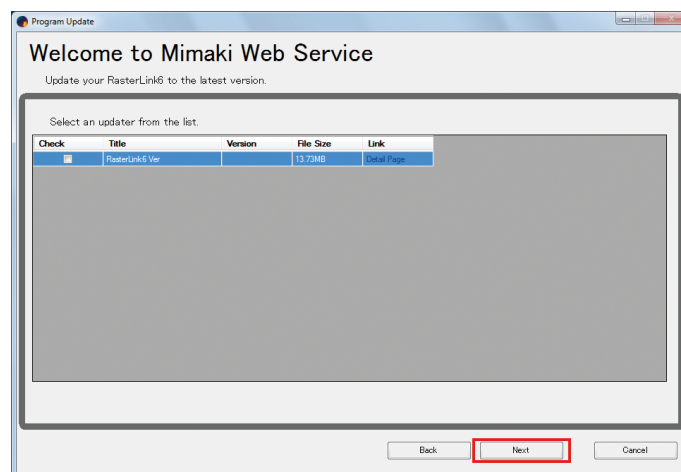

5 Click [Finish].

6 Start RasterLink6Plus.

- The updater will be applied.

Version upgrade with a CD

- 1 Insert the installation CD with a newer version of RasterLink than that of RasterLink that has been installed.

Important! • Overwrite installation of an older version (downgrading) is not possible.

- 2 In the installation menu, click **[Update RasterLink6Plus]**.
 - The [Choose Setup Language] dialog box appears.
- 3 Select the language of your choice for the setup and then click **[OK]**.

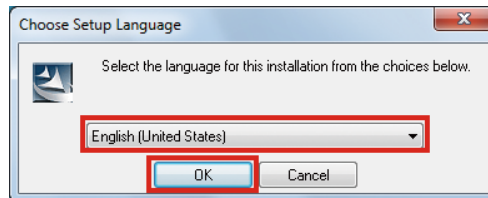

- 4 Click **[Next]**.
- 5 Click **[Install]**.
 - The version upgrade is started.
- 6 Click **[Finish]**.
- 7 Restart the PC.

Download of the update tool from the official website

You can download the updater from our official site (<https://mimaki.com/download/software.html>).

For how to update the software, visit the official website.

Important! • [Program Update] is not available before the license is activated.
• We recommend that you visit the official website regularly.

Chapter 3 RasterLink6Plus enhancements



This chapter

RasterLink6Plus has the following two enhancements:

1. RasterLinkTools
2. CuttingLink

This chapter explains these two enhancements.

Installation and version upgrade of
RasterLinkTools38

CuttingLink installation39
System requirements39
Installation procedure.....39

3.1 Installation and version upgrade of RasterLinkTools

RasterLinkTools is an Adobe Illustrator plug-in tool to create print and cut data as well as images for special colors used in RasterLink6 or later. You must install the tool separately from RasterLink6Plus.

For installation procedure, refer to the accompanying "RasterLinkTools Guide" at our official site.

3.2 CuttingLink installation

CuttingLink is a tool to manage cut data with ID Cut. You must install the tool separately from RasterLink6Plus. For details, refer to the ID cut guide.

System requirements

The table below shows the requirements to install and use CuttingLink.

CuttingLink installation PC

OS	Microsoft® Windows 7® Home Premium Service Pack1 or later (32-bit/64-bit version) Microsoft® Windows 7® Professional Service Pack1 or later (32-bit/64-bit version) Microsoft® Windows 7® Ultimate Service Pack1 or later (32-bit/64-bit version) Microsoft® Windows 7® Enterprise Service Pack1 or later (32-bit/64-bit version) Microsoft® Windows 8.1® (32-bit/64-bit version) Microsoft® Windows 8.1® Pro (32-bit/64-bit version) Microsoft® Windows 8.1® Enterprise (32-bit/64-bit version) Microsoft® Windows 10® Home (32-bit/64-bit version) Microsoft® Windows 10® Pro (32-bit/64-bit version) Microsoft® Windows 10® Enterprise (32-bit/64-bit version) Microsoft® Windows 11® Home Microsoft® Windows 11® Pro
----	---

Installation procedure

- 1 Go to our official website (<https://mimaki.com/download/software.html>) and download the installer of CuttingLink.
- 2 Double-click the installer.
 - The installer is started.

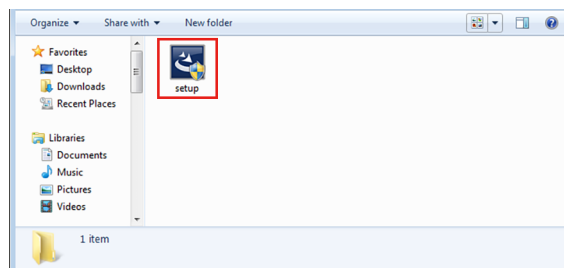

- 3 Select the language you use during installation, and click [OK].
 - If Microsoft .NET Framework is not installed in the PC, the installer for .NET Framework is started. Install .NET Framework separately.

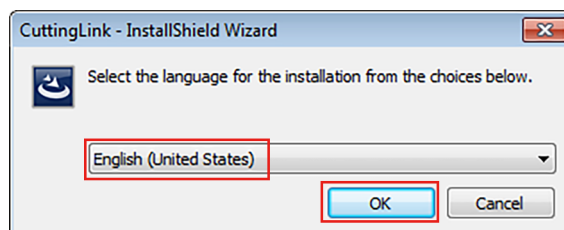

4 Click [Next].

5 Select [I accept the terms in the license agreement] and click [Next].

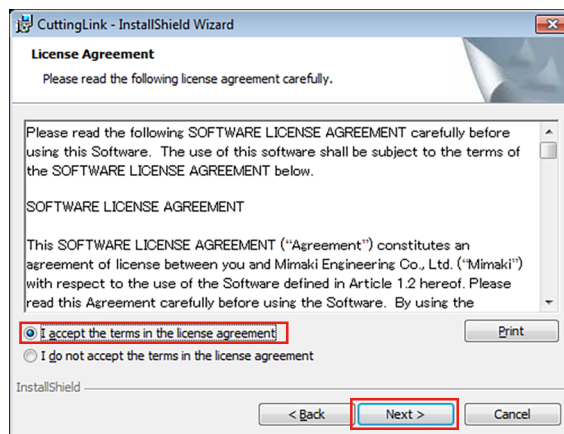

6 Click [Install].

7 Click [Finish].

- The installation is now completed.

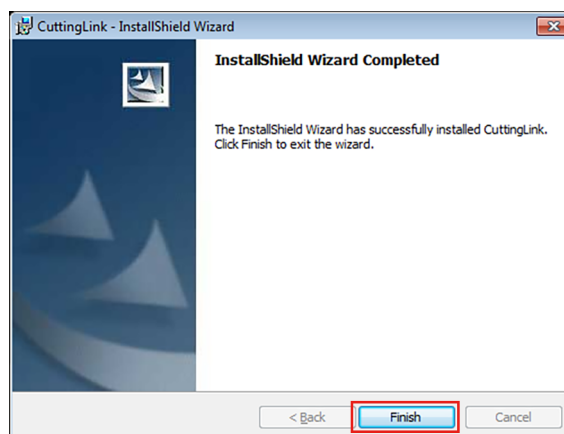

Chapter 4 RasterLink6Plus uninstallation



This chapter

This chapter explains the uninstallation procedure of RasterLink6Plus.

Uninstallation procedure.....	42	Uninstallation procedure.....	49
How to deactivate the license.....	43		
When the RasterLinkPC has Internet access			
.....	43		
When the RasterLinkPC has no Internet			
access.....	44		

4.1 Uninstallation procedure

1. Deactivate your license

 ["How to deactivate the license"\(P. 43\)](#)

- Deactivate the license.

2. Uninstall RasterLink6Plus

 ["Uninstallation procedure"\(P. 49\)](#)

- Uninstall RasterLink6Plus.

4.2 How to deactivate the license

Before uninstalling RasterLink6Plus, you need to deactivate your license.

You can deactivate it in the following two ways:

-  "When the RasterLinkPC has Internet access"(P. 43)
-  "When the RasterLinkPC has no Internet access"(P. 44)

Important!

- If you uninstall the software without deactivating the license, you will see a screen during uninstallation to prompt you to deactivate the license.
- Make sure you deactivate the license on the authenticated PC before installing the software in a different PC. If you do not deactivate the license, you cannot activate the license when installing RasterLink6Plus in another PC, resulting in failure to use the software continuously.

When the RasterLinkPC has Internet access

1 From the [Start] menu, select [Mimaki RasterLink6Plus] - [License].

- The [Deactivation] screen appears.

2 Click [Next].

- If you are using a proxy server, then click [Internet access option] and configure the settings for the proxy server.
- The software connects to the server to deactivate the license.

Important!

- If you are using a personal firewall, a connection confirmation screen may appear. In this case, allow the connection.



3 Click [Finish].

- The deactivation of the license is now completed.



When the RasterLinkPC has no Internet access

If the RasterLinkPC has no Internet access, you can use a substitution, just like the substitute activation, to deactivate the license.

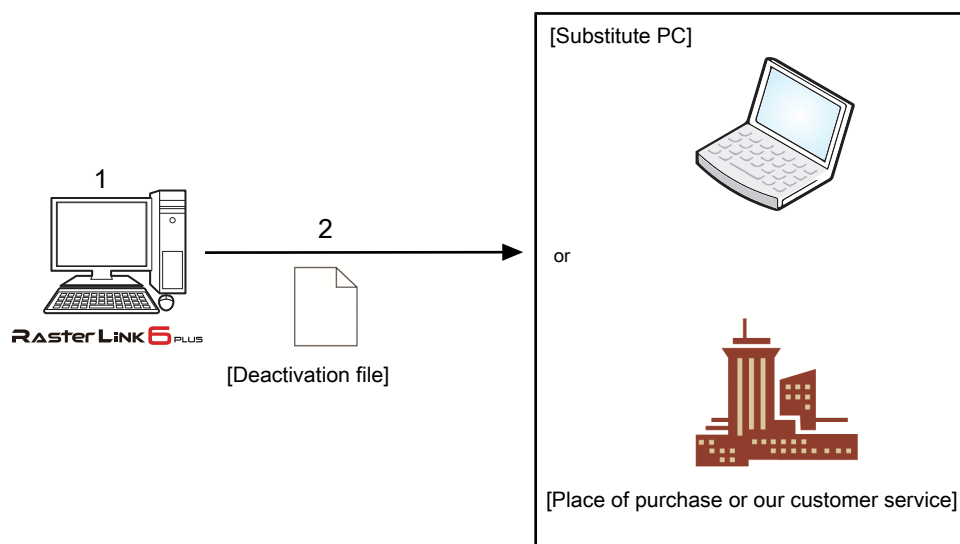

1 Create a deactivation file

- On the RasterLinkPC, create a deactivation file.
☞ ["Operation on the RasterLinkPC"\(P. 45\)](#)

2 Deactivate the license.

- If you have a PC with Internet access, copy the deactivation file to the PC and deactivate the license.
☞ ["Steps on the substitute PC"\(P. 47\)](#)
- If you do not have an environment with Internet access, you can send the deactivation file to us or a distributor for the purpose of license deactivation.

Operation on the RasterLinkPC

- 1 From the [Start] menu, select [Mimaki RasterLink6Plus] - [License].
 - The [Deactivation] screen appears.
- 2 Click [Activate your license.]

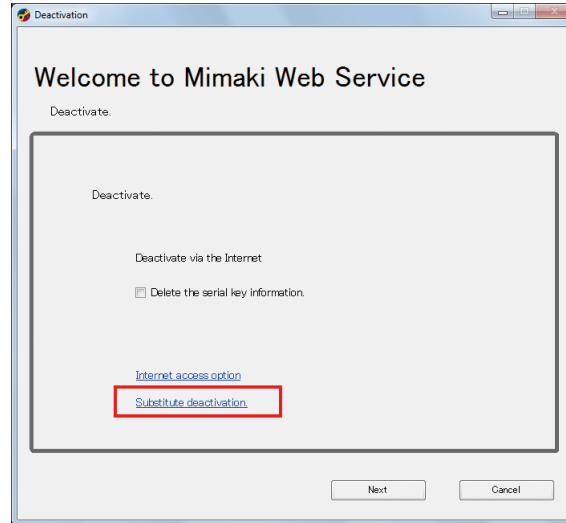

- 3 Save the deactivation file.

(1) Click [Browse].

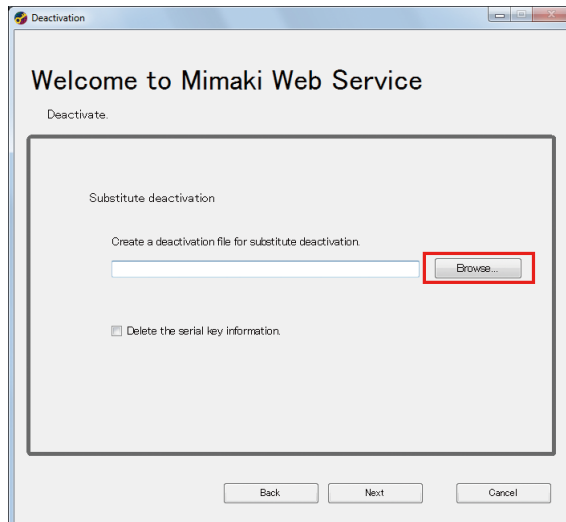

(2) In the [Save the license release file] dialog box that appears, enter any name and then click [Save].

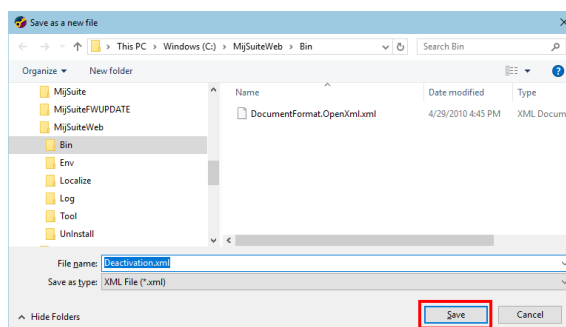

4 Click [Next].

- The deactivation file is created.

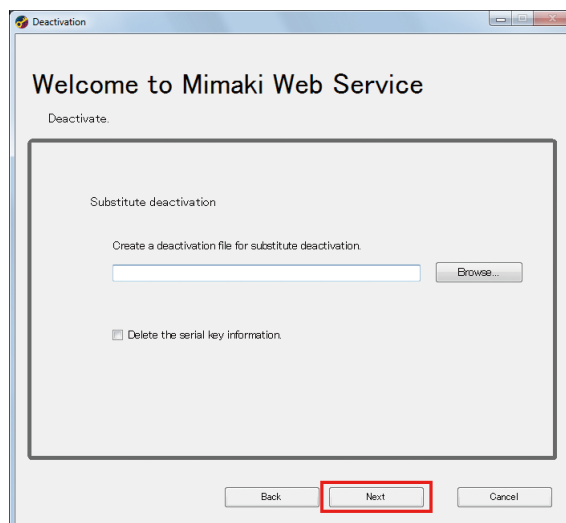

5 Click [Finish].

- The steps on the RasterLinkPC are now completed.
- At this point, the license for RasterLink6Plus has been deactivated and thus you cannot use the software.
- If you deactivate the license by using a substitute PC, copy the deactivation file to the substitute PC.
 ["Steps on the substitute PC"\(P. 47\)](#)
- If you want to ask the distributor or us to deactivate the license, contact the relevant customer service department.



Important!

- Keep the deactivation file in a safe place until the license deactivation is finished. If you lose the file before deactivation, you cannot deactivate the license and thus RasterLink6Plus is not available on another PC.

Steps on the substitute PC

1 Start the web browser and enter the following URL.

- <http://miws.mimaki.jp/license/agencytop.aspx>
- The license activation screen appears.

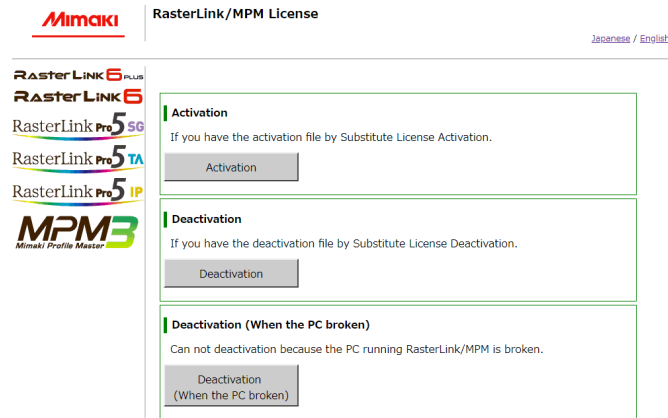

2 Click [Deactivation].

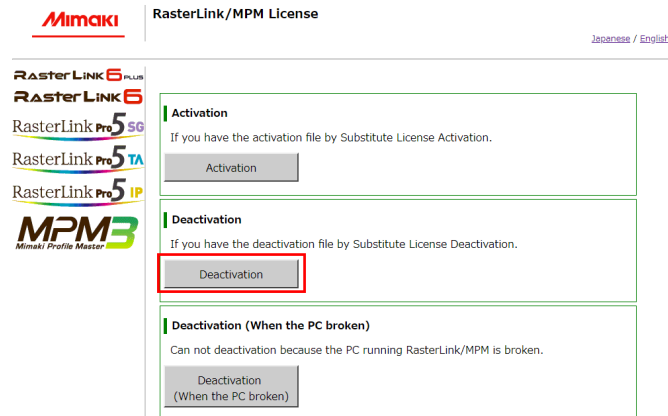

3 Click [Browse].

- The dialog box appears.

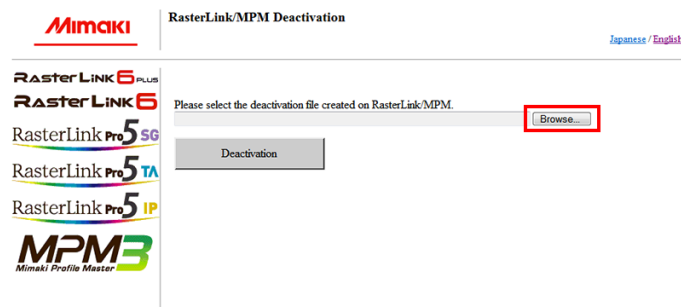

4 Select the deactivation file you created on the RasterLinkPC and click [Open].

5 Click [Deactivation].

- The deactivation of the license is now completed.

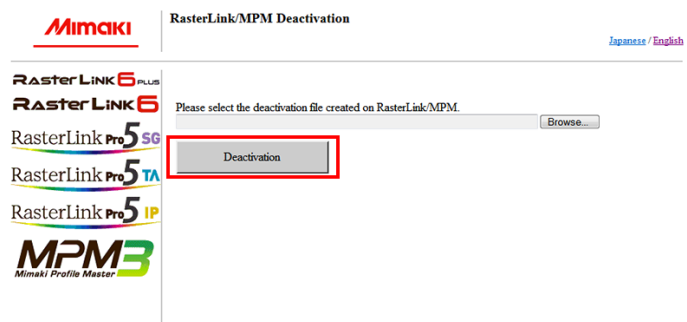

4.3 Uninstallation procedure

This section explains the uninstallation procedure of RasterLink6Plus.

Important! When you perform uninstallation, all the settings for RasterLink6Plus will be removed. Before starting uninstallation, check that:

- RasterLink6Plus is not running.
- The license for RasterLink6Plus has been deactivated.
- The hot holder for RasterLink6Plus is not open (even via the network).
- Any printers registered in RasterLink6Plus are not used (even via the network).
- The hot folder and printer for RasterLink6Plus are not shared via the network connection with Macintosh (such as SMB) for use.

1 In [Control Panel], double-click [Programs and Features].

- Depending on your OS, you may see [Add and Remove Programs], instead of [Programs and Features].

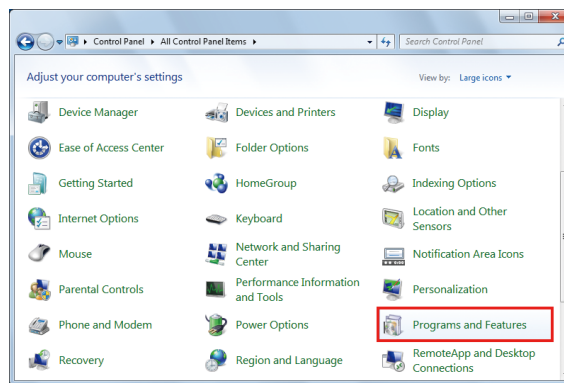

2 From the list in the [Name] column, select [Mimaki RasterLink6Plus].

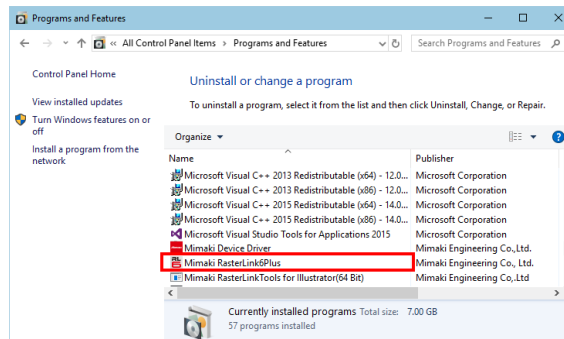

3 Click [Uninstall].

- Depending on your OS, you may see [Remove].
- The [Programs and Features] dialog box appears.

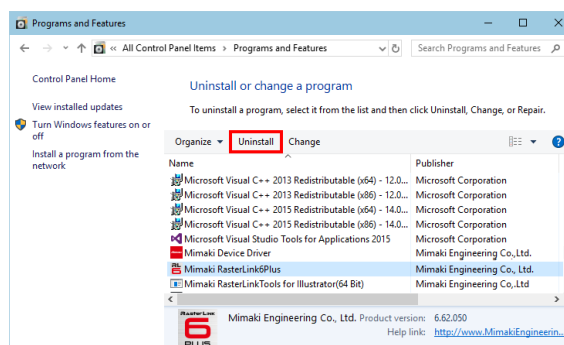

4 Click [Yes].

- The uninstallation is started.



Important!

- If you have not deactivated the license, the screen to prompt you to do so appears. When you click [Yes], the [Deactivation] screen appears.  ["How to deactivate the license"\(P. 43\)](#)
After deactivating the license, you can continue the uninstallation. If you click [No], the uninstallation continues without license de-activation.

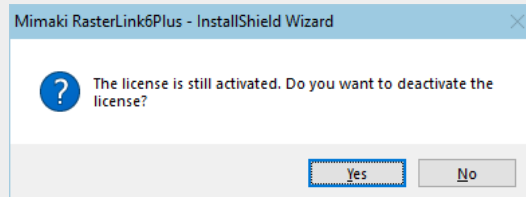

- You may see the message below during uninstallation. In this case, delete the installation folder manually after the uninstallation.

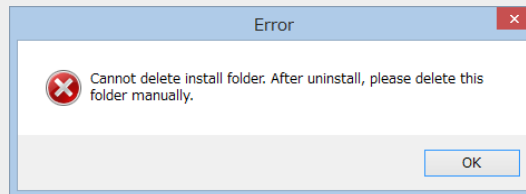

5 Click [Yes] to restart the PC.

- The uninstallation is now completed.

Important!

If you reinstall RasterLink6Plus after uninstalling it, RasterLink6Plus may not work properly when the folders below remain. Make sure you delete the folders before reinstallation.

- Installation folder created in the previous installation
- Working folder used previously

Chapter 5 Troubleshooting related to license activation



This chapter

This chapter explains how to deal with issues by case example and how to deactivate the license when the PC fails.

Troubleshooting by case example.....	52
If, without deactivating the license, you have	52
If you replaced the PC without deactivating the license	52
If you cannot use the software because an error message appears when running [Program Update] or [Profile Update] after the PC was sent for repair	52
If you lost the serial key	52
How to deactivate the license if the PC fails ...	54

5.1 Troubleshooting by case example

This section describes how to troubleshoot issues when an error occurs during license activation.

If, without deactivating the license, you have

- Uninstalled RasterLink6Plus
- Re-installed the OS
- Replaced the hard disk drive that has the OS

You can activate the license as many times as you want on the PC where you activated the license first, unless you activate the license on another PC.

● If you want to use RasterLink6Plus on the same PC again

- (1) Reinstall RasterLink6Plus.
- (2) Start the license activation and enter the same serial key.
 - The license is activated again.

● If you want to use RasterLink6Plus on a different PC

- (1) On the web, perform the license de-activation process to disable the license.
 - ☞ ["How to deactivate the license if the PC fails"\(P. 54\)](#)
- (2) Install RasterLink6Plus in the PC where you want to use RasterLink6Plus.
- (3) Start the license activation and enter the serial key for the license you deactivated in step (1).

If you replaced the PC without deactivating the license

On the web, perform the license de-activation process to disable the license.

☞ ["How to deactivate the license if the PC fails"\(P. 54\)](#)

If you cannot use the software because an error message appears when running [Program Update] or [Profile Update] after the PC was sent for repair

RasterLink6Plus collects information from specific devices on the PC when the license is activated. Any of the devices may be replaced when the PC was repaired. If this happens, you need to activate the license again. Follow the steps below to activate the license:

- (1) On the web, perform the license de-activation process to disable the license.
 - ☞ ["How to deactivate the license if the PC fails"\(P. 54\)](#)
- (2) On the RasterLinkPC where the error occurred, start RasterLink6Plus.
 - The license is activated again.

If you lost the serial key

● If you uninstalled RasterLink6Plus without deactivating the license

In this case, the PC still has the serial key information. Reinstall RasterLink6Plus and start the license activation to show the serial key you entered in the previous installation on the serial-key-entry screen.

- **If you realize the serial key was lost after you deactivate the license**

In this case, the PC still has the serial key information if the [Delete the serial key information.] check box in the [Deactivation] screen was cleared when the license was deactivated. The check box is cleared by default.

In the serial-key-entry screen, check that the serial key you entered previously is displayed.

5.2 How to deactivate the license if the PC fails

If you cannot perform the normal license de-activation process and use RasterLink6Plus on any other PC, you can follow the steps below to deactivate the license.

- Important!**
- If you can use the normal license de-activation process, do not use this function. RasterLink6Plus may not be able to work properly.
☞ ["How to deactivate the license"\(P. 43\)](#)

1 Open a web browser and enter the following URL.

- <http://miws.mimaki.jp/license/agencytop.aspx>
- The license activation screen appears.

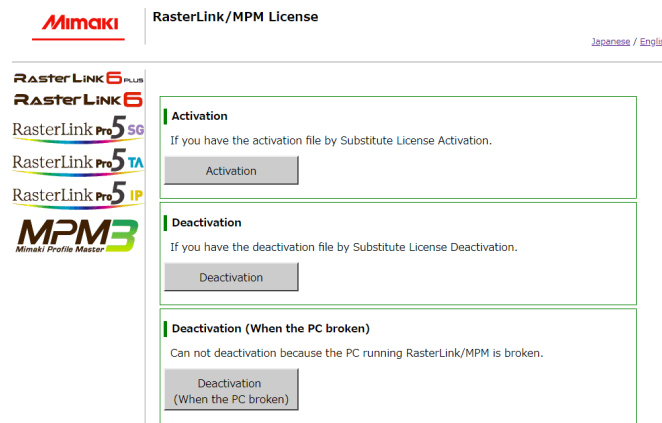

2 Click [Deactivation (When the PC broken)].

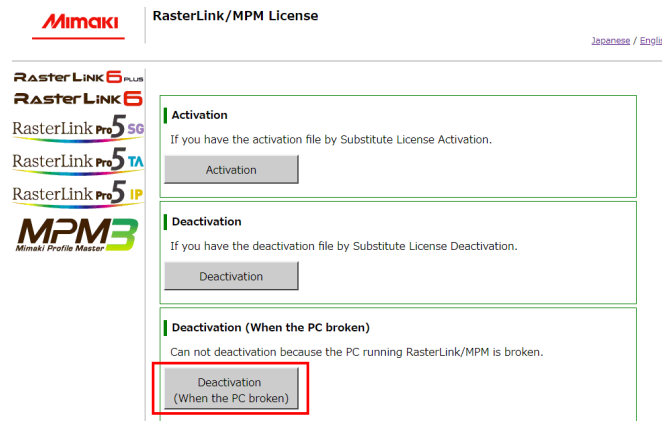

3 In the serial-key-entry form, enter the serial key for the activated license.

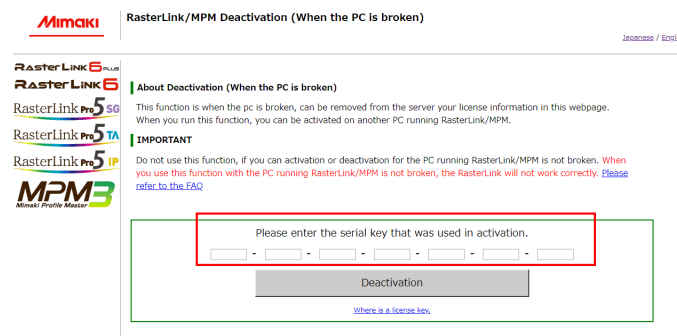

4 Click [Deactivation].

- The deactivation of the license is now completed.

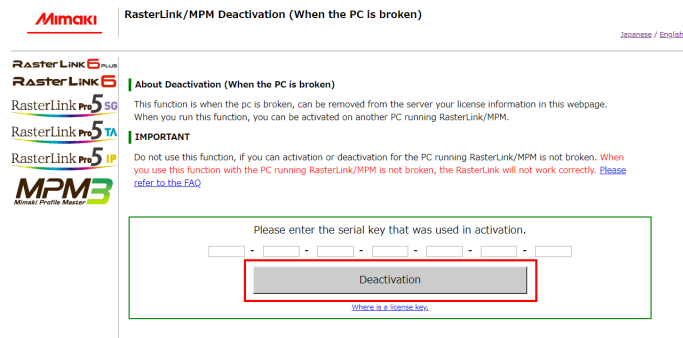

RasterLink6Plus Installation Guide

April, 2023

MIMAKI ENGINEERING CO.,LTD.

2182-3 Shigeno-otsu, Tomi-shi, Nagano 389-0512 JAPAN

D203210-22-21042023

