

COLOR INKJET PRINTER

JV5-320DS

for exclusive use

OPERATION MANUAL

This Operation Manual is usable for the firmware version 7.5 and later.

CAUTION

This machine is a color ink-jet printer for high quality printing realizing printing on fabric media (for soft sign), based on the JV5-320S.

To use this machine safely and effectively, thoroughly read “Dedicated Operation Manual of JV5-320DS (this manual)” and attached “JV5-320S Operation Manual” and fully understand their contents.

MIMAKI ENGINEERING CO., LTD.

URL : <http://eng.mimaki.co.jp/>

Foreword

Congratulations on your purchase of MIMAKI color ink jet printer “JV5-320DS” .

The JV5-320DS is a color ink-jet printer for high quality printing realizing printing on fabric media (for soft sign) with sublimation transfer ink (4-color and 6-color), based on the color ink-jet printer JV5-320S.

How to read this Operation Manual

To use this machine safely and effectively, thoroughly read "Dedicated Operation Manual of JV5-320DS (this manual)" and attached "JV5-320S Operation Manual" and fully understand their contents.

Dedicated Operation Manual of JV5-320DS (this manual)

Explains unique operation for JV5-320DS and its maintenance.

JV5-320S Operation Manual

Explains operation for JV5-320S and its maintenance.

For function explanation overlapped with the JV5-320DS, refer to the operation manual for the JV5-320S to perform the operation and the maintenance.

TABLE OF CONTENTS

CHAPTER 1 Safety Precautions

Types of media that can be used	1-2
Basic specifications	1-3
Specifications for ink	1-5

CHAPTER 2 Before Use

Configurations and Functions	2-2
Front side of machine (left side).....	2-2
Rear	2-3
Relationships between ink station and head row	2-4
Operation Panel	2-5
Operation to set function menus	2-6
How to make setting	2-6
Outline of menu hierarchy	2-8
Setting values in function menus	2-11

CHAPTER 3 Printing

Adjusting the head gap	3-2
Setting the media on the printer	3-3
Attaching/removing platen sheet metal	3-4
Setting position for fabric media.....	3-6
Setting media	3-7
Setting the media using the roll holder.....	3-15
How to operate the take-up device	3-16
Notes on media edge surface and pinch roller	3-17
Effective Plotting Area	3-18
Establishing the Origin	3-19
Other notes	3-20
Handling of media after drawing	3-20
When cutting media	3-21
Use method of rear surface dryness fan	3-22

CHAPTER 4 Daily Care

Routine Maintenance	4-2
Notes on cleaning solution	4-2
Cleaning of platen sheet metal/platen sheet metal holder	4-2
Cleaning the media sensor (2 places)	4-2
Replace the filter of exhaust fan in the rear	4-3
Replace the filter of the slider fan	4-4
Cleaning of ink tray/ink tray sheet metal	4-6

CHAPTER 5 In Case of Trouble

Warning errors newly added	5-2
Error messages newly added	5-2

CHAPTER 6 Operation for Functions

Functions Invoked by [FUNCTION] Key	6-2
Invoking SET UP functions	6-2
Registering printing conditions in a lump (type registration)	6-2
List of functions	6-2
Outline of the setup functions	6-4
Invoking MAINTENANCE functions	6-11
List of functions	6-11
Setting a maintenance function	6-12
Make setting of the media remaining amount display function [MEDIA RESIDUAL]	6-13
Moving the printer safely [BeforeMovingIt.]	6-14
Invoking MACHINE SETUP functions	6-15
List of functions	6-15
Functions of [INFORMATION] key	6-16
Setting a MACHINE SETUP	6-16
Outline of the machine setup functions	6-17
Invoking NCU functions	6-23
List of functions	6-23
Setting a NCU functions	6-23
Outline of the NCU functions	6-24
DISPLAY setting	6-26
Applied settings of functions	6-27
Settings of heaters	6-27

Detailed settings of heaters	6-28
How to operate function menus.....	6-30
Functions related to print quality.....	6-31
Correcting media feed during printing [FEED COMPENSATION.]	6-31
Functions related to ink.....	6-32
When ink sets (4-color, 6-color) are to be changed	6-32
Function Flowchart [BOOT].....	6-34
Function Flowchart [LOCAL mode].....	6-36
Function Flowchart [REMOTE mode].....	6-40
Function Flowchart [FUNCTION Key].....	6-42



CHAPTER 1

Safety Precautions



This chapter describes the precautions to be taken for safe use of the printer.

Types of media that can be used	1-2
Basic specifications	1-3
Specifications for ink	1-5

Types of media that can be used

You can use only the roll media with this machine.

Important! ■ Leaf media cannot be used.

The types and sizes of media that can be used with the printer are explained below.

Types of media that can be used

- Transfer paper
- Fabric (for soft sign graphics)

Sizes of media that can be used

Maximum width	3300 mm
Minimum width	297 mm
Maximum printing width	3250 mm (to print on fabric) 3290 mm (to print on paper)
Thickness	5.0 mm or less (for the media that can be fed)
Roll weight *1	130 kg or less
Roll outside diameter	φ 250 mm or less
Roll inside diameter	3 inches
Side printed	You can print on both sides.
Roll end treatment	The roll end is gently fixed to the core with weak-adhesive tape or weak glue for easy removal.

*1. Without deflection of the roll when it is retained at both ends.

Basic specifications

Item		Specification
Print head	Method	Drop-on-demand piezoelectric print heads
	Specification	4-heads Staggerds
Drawing mode (scan x feed)		720 x 540dpi 540or720 x 720dpi 540 x 900dpi 540or720 x 1080dpi 720 x 1440dpi 1440 x 1440dpi
Usable inks		Sublimation transfer ink :4 colors (Y,M,BI,K) / 6 colors (Y,M,BI,K,LBI,Lm)
Ink supply		Automatic switching between two ink cartridges integrated as one unit
Capacity of ink cartridge		6-color set of cartridges: 440 cc cartridge; 2 cartridges for each color 880 cc/1 color (4 cartridges :only for M,BI,1760cc) 4-color set installed: 440 cc cartridge; 4 cartridges for each color 1760 cc/1 color
Media type		Transfer paper, Fabric media (for soft sign graphics)
Max. printing width		3250 mm (to print on fabric) 3290 mm (to print on paper)
Roll Media size	Maximum	3300 mm
	Minimum	297 mm
	Thickness	5.0 mm or less (for the media that can be fed)
	Roll outside diameter	φ 250 mm or less
	Roll weight *1	130 kg or less
	Roll inside diameter	3 inches
	Plotting surface	You can print on both sides.
	Roll end treatment	The roll end is gently fixed to the core with weak-adhesive tape or weak glue for easy removal.
Margin *2		Left end and right end:to print on fabric 25 to 50 mm (Default) to print on paper 25 to36 mm (Default) Front:150 mm Rear:0 mm
Distance accuracy	Absolute accuracy	Whichever the larger one of ± 0.3 mm or ± 0.3 % of the designated
	Reproducibility	Whichever the larger one of ± 0.2 mm or ± 0.1 % of the designated
Perpendicularity		± 0.5 mm / 1000 mm
Media skew		5 mm or less / 10 m variable
Head height adjustment		1.5 to 5.0 mm
Media delivery		Take-up device supplied as a standard accessory (switching possible between take-up with print side inside and take-up with print side outside), which can be used only with a 3-inch core
Waste ink tank		Bottle type (4,000 cc) FULL state is detected with sensor
Interface		USB 2.0
Command		MRL-III
Noise	during standby	Less than 58 dB (FAST-A, Front & Rear & Left & Right 1 m)
	during continuous printing	Less than 65 dB
	during discontinuous printing	Less than 70 dB
Nozzle check unit (Option)		Laser beam type (CLASS 1 or below)
Safety Standard		VCCI-Class A, FCC-Class A, UL 60950-1, CE Marking (EMC,), CB Report, RoHS, CLASS 1 Laser *3
Power		AC 200 - 240 V ± 10%, 50/60 Hz ± 1 Hz 30A or less
Power consumption *4		7200 VA or less

1 Safety Precautions

Item		Specification
Recommended Environment	Available temp.	20 °C to 35 °C
	Humidity	35 to 65 % Rh (No condensation)
	Guaranteed temp.	20 °C to 25 °C
	Temperature change	± 10 °C / h or less
	Dust	Equivalent to normal office level
Weight	Main unit	1200 kg
Outside dimensions	Width	5170 mm
	Depth	1610 mm
	Height	1640 mm

*1. Without deflection of the roll when it is retained at both ends.

*2. The margin of the right and left changes depending on the clipping of the media retainer.

*3. When option is used

*4. Main unit and heater

Specifications for ink

Item		
Supply		Dedicated sublimation transfer ink cartridge
Color		Black ink cartridge Blue ink cartridge Magenta ink cartridge Yellow ink cartridge Light blue ink cartridge Light magenta ink cartridge
Ink capacity		440 cc per cartridge
Shelf life		1 year from the date of manufacture (at room temperature)
Storage temperature	Storage	1 to 40°C (Storage at temperature of 40°C is permitted within a month.)
	Transportation	1 to 60°C (Storage at temperature of 60°C is only permitted within 120 hours, and at temperature of 40°C is permitted within a month.)

Important!

- Do not disassemble ink cartridges or refill them with ink.
- Ink could freeze if kept in a cold place for an extended period. If the ink freezes, thaw it at room temperature (25°C) spending more than three hours before use.
- When sublimation transfer ink is used, if the ink freezes, the quality is changed and the ink becomes unusable. Store the ink in an environment that will not freeze the ink.

CHAPTER 2

Before Use



This chapter describes the names of parts and how to use the operation panel.

Configurations and Functions	2-2
Operation Panel	2-5
Operation to set function menus	2-6

Configurations and Functions

This chapter explains name of each part and the operation panel of this machine.

Important!

■ Here, only different in point from the JV5-320S are explained. For other names and functions, refer to the JV5-320S Operation Manual.

Front side of machine (left side)

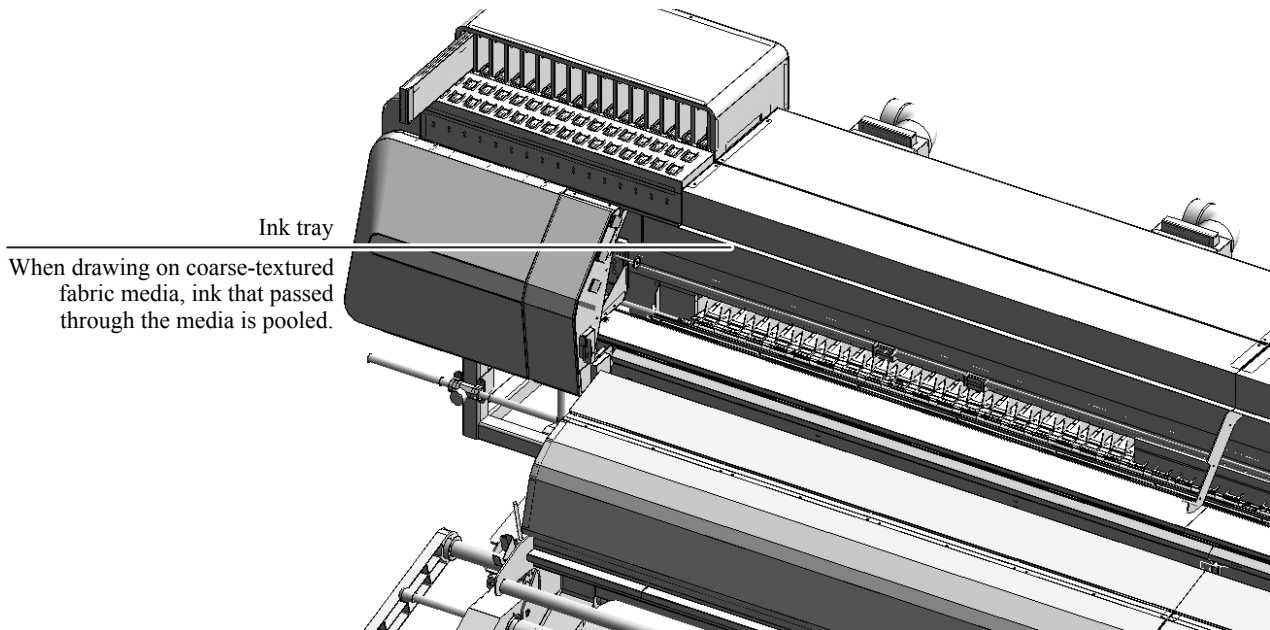

Rear

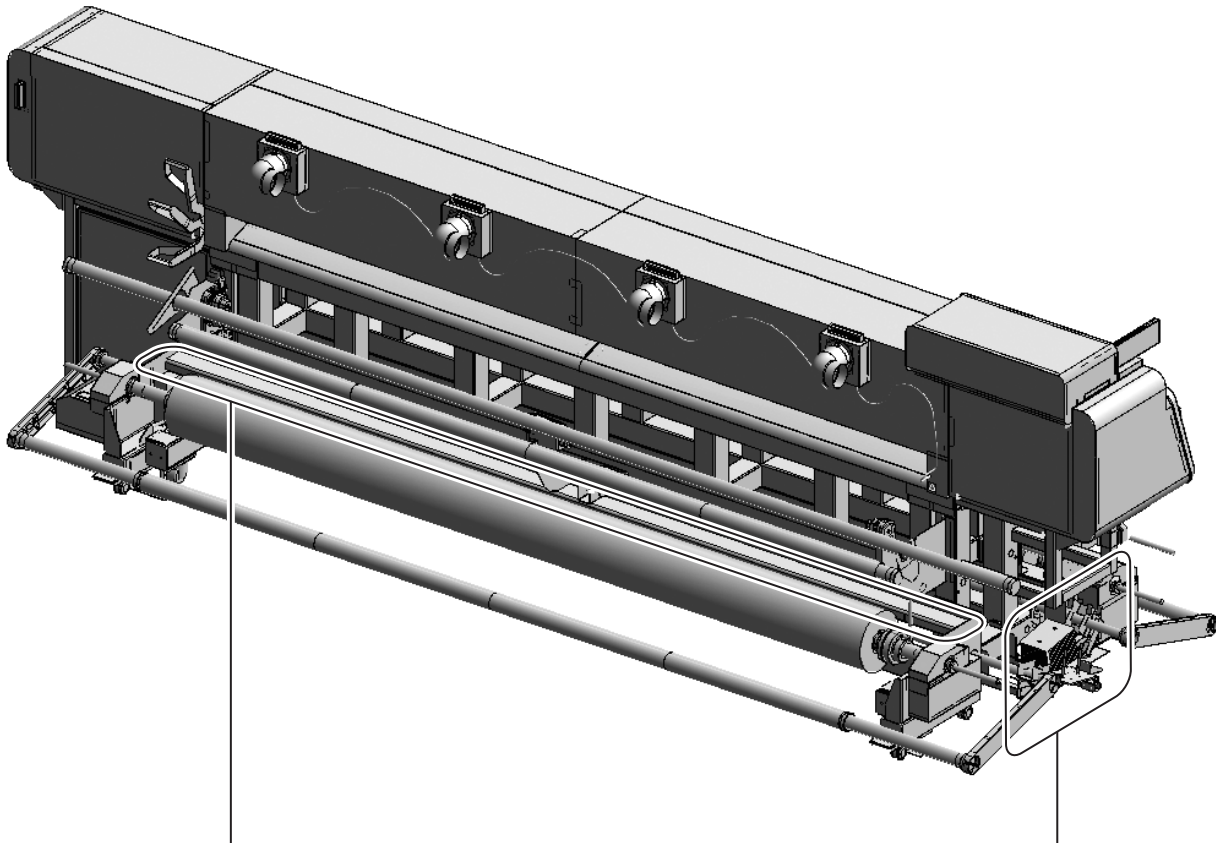

Media setting position NG label
 This is the guide for setting the media. Make the edge surface of the media do not enter within the black area of the label (otherwise, the media press does not function).

Counter weight attaching arm
 Attach the weight to adjust the weight of the take-up/feeding tension bar.

- Contents
- Chapter 1
- Chapter 2**
- Chapter 3
- Chapter 4
- Chapter 5
- Chapter 6

Relationships between ink station and head row

The carriage mounts four heads each with eight rows of nozzles.

One color ink is applied to each row of nozzles.

Remember these relationships when checking the heads for clogged nozzles, replacing ink cartridge and replenishing inks.

And cartridges of ink station are different from the selection of ink set (4 color ink set, 6 color ink set) when the full up ink is performed.

K	Black
M	Magenta
BL	Blue
Y	Yellow
LBL	Light Blue
Lm	Light Magenta

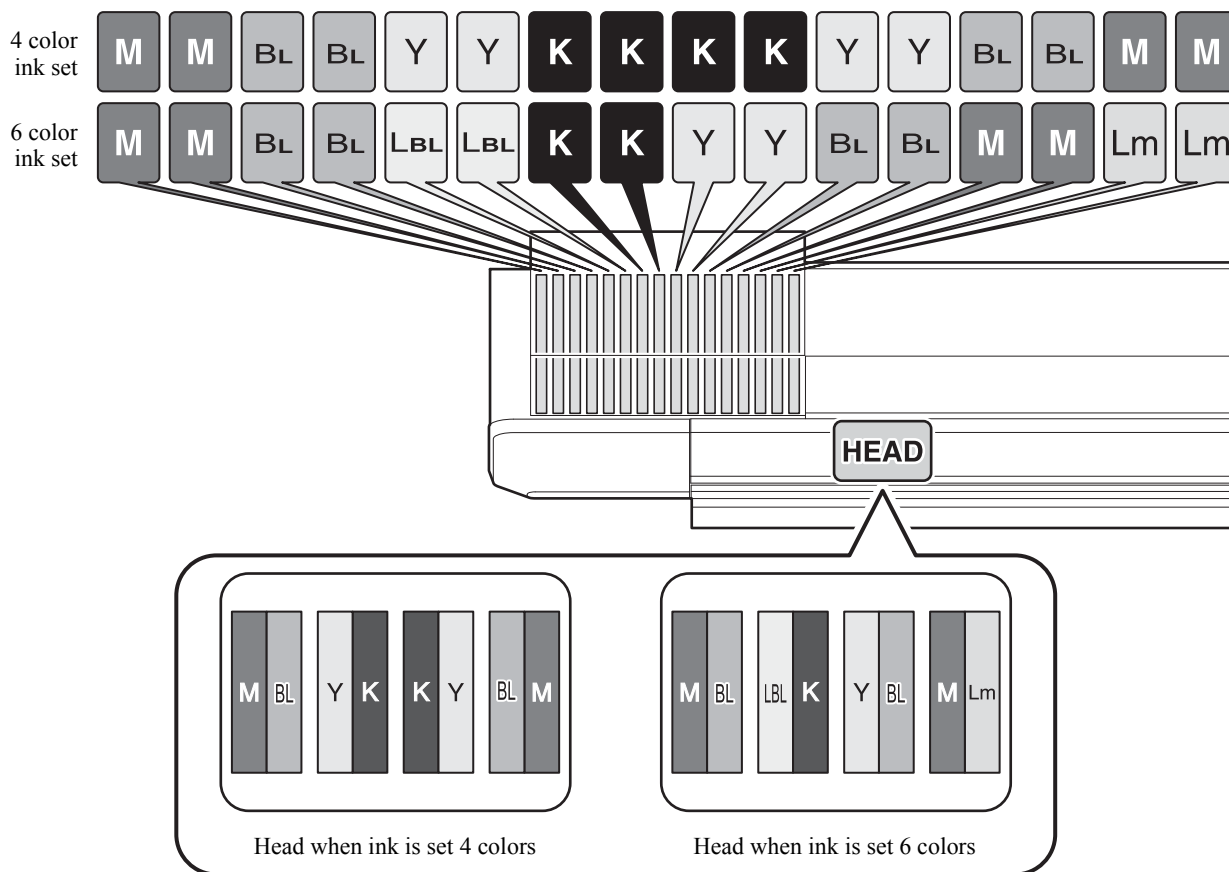

4 color ink set	Four ink cartridges for each color.
6 color ink set	Two ink cartridge for each of K, Y, LBL and Lm and four ink cartridges for each of M and BL.

Operation Panel

The operation panel of this machine functions in the same way as that of the JV5-320S with exception of the following points.

- As this machine is not equipped with the print heater, lamps related to the print heater does not light. In addition, the temperature of the print heater is not displayed on the screen in the waiting status.

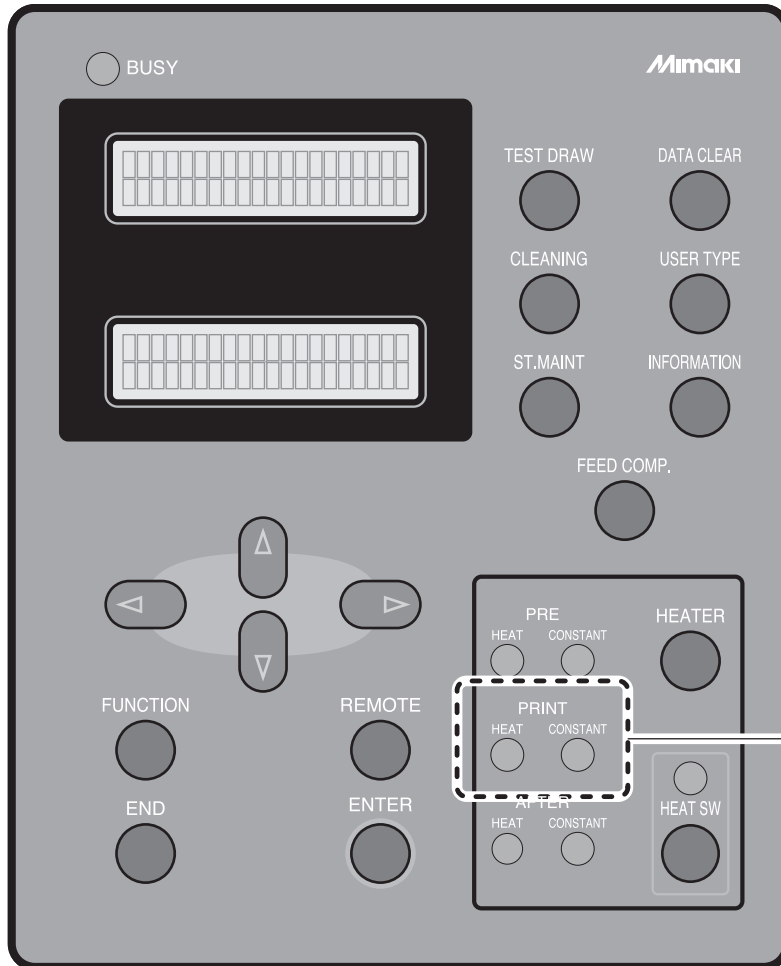

These do not light for the JV5-320DS.

Operation to set function menus

To set a function menu, press the [FUNCTION] key in LOCAL mode and press [▲], [▼], [◀] or [▶] or [ENTER] key as appropriate. If the printer is not in LOCAL mode, press the [REMOTE] key once.

How to make setting

As an example of setting procedure, that for [SET UP] → [AUTO CLEANING] is described below.

STEPS:

1 Make sure that the printer is in LOCAL mode.

If it is in REMOTE mode, press the [REMOTE] key.

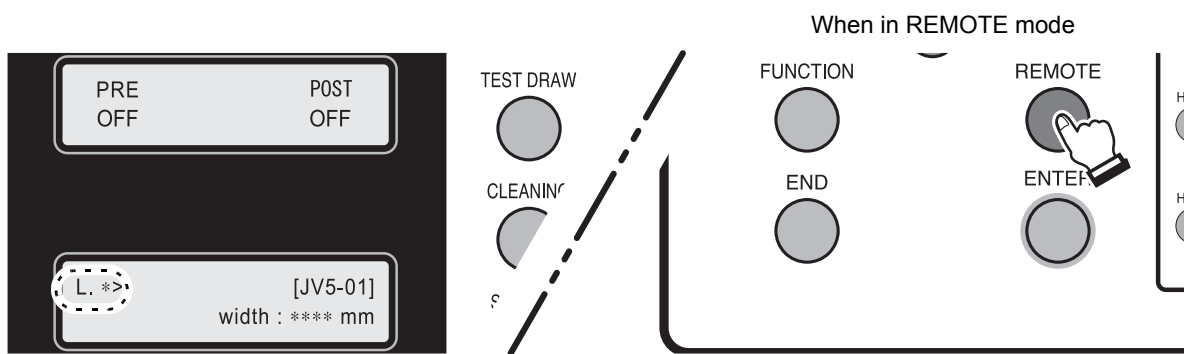

2 Press the [FUNCTION] key.

Once the following screen is displayed, press the [ENTER] key twice to go to the lower level of the hierarchy.

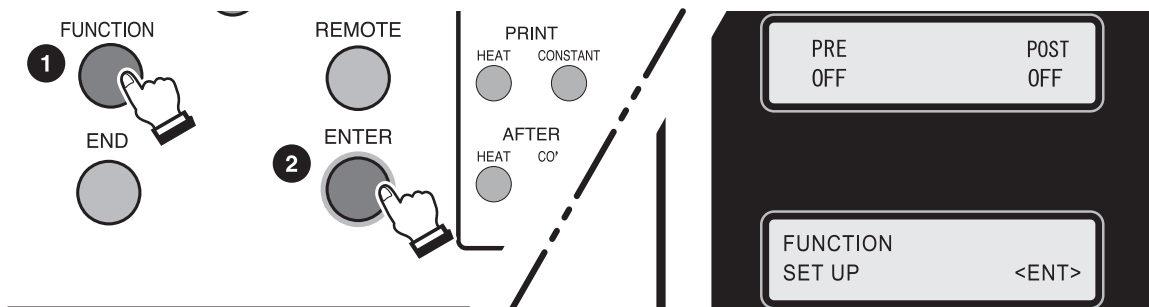

3 Press the [▼] key 11 times to select [AUTO CLEANING], and press the [ENTER] key.

The menu screen will turn into the screen for setting ON/OFF of automatic cleaning.

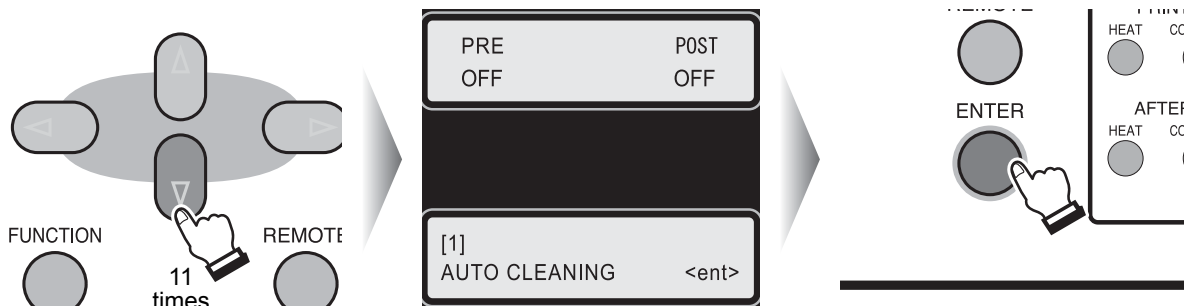

4 Press the [▲] or [▼] key to set ON/OFF of automatic cleaning.

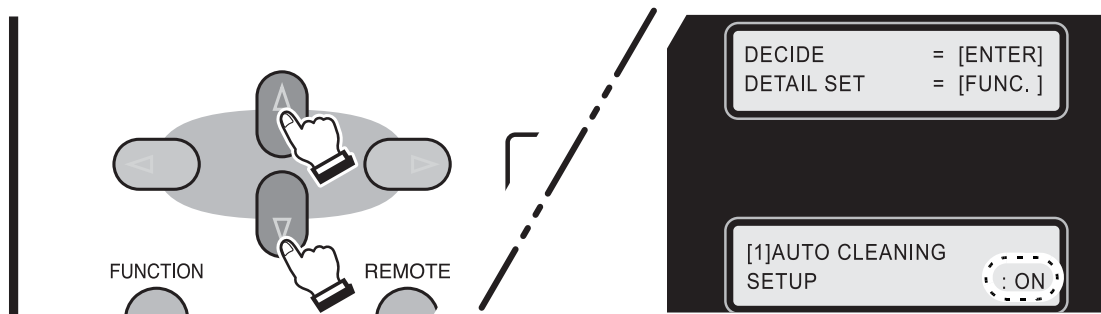

5 Press the [FUNCTION] key again if the setting of [CLEANING INTERVAL] and [CLEANING TYPE] is needed.

This setting is permitted only when automatic cleaning [ON] is selected.

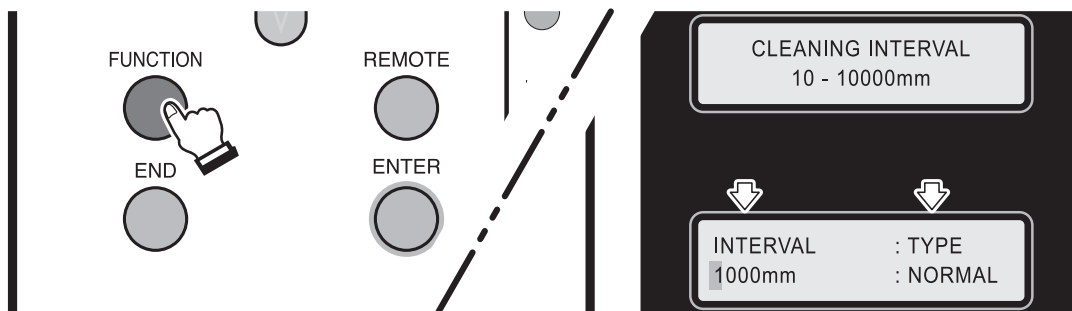

6 Press the [FUNCTION] key to go to the lower level of hierarchy and press the [▲] or [▼] key to input [CLEANING TYPE].

Press the [◀] or [▶] key to display the setting screen for [CLEANING TYPE] and press the [▲] or [▼] key to set a cleaning type.

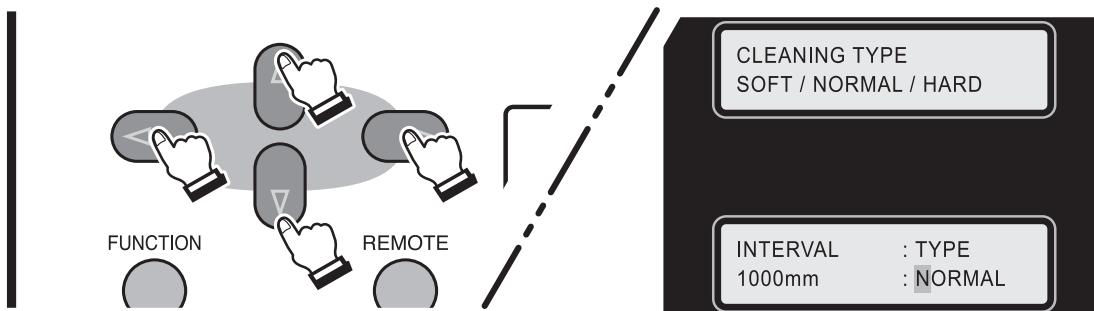

7 Press the [ENTER] key twice to finalize the setting.

Press the [END] key several times to return to LOCAL mode.

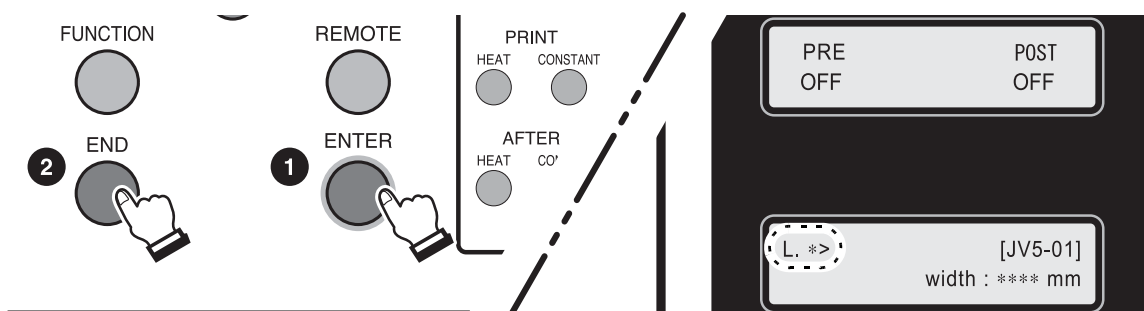

Outline of menu hierarchy

Function menu

Press the [FUNCTION] key to invoke the function menu.

*1 To be displayed only when the warning or error message for "Flushing BOX Cleaning"

*2 To be displayed only when the machine is equipped with the nozzle check unit (option)

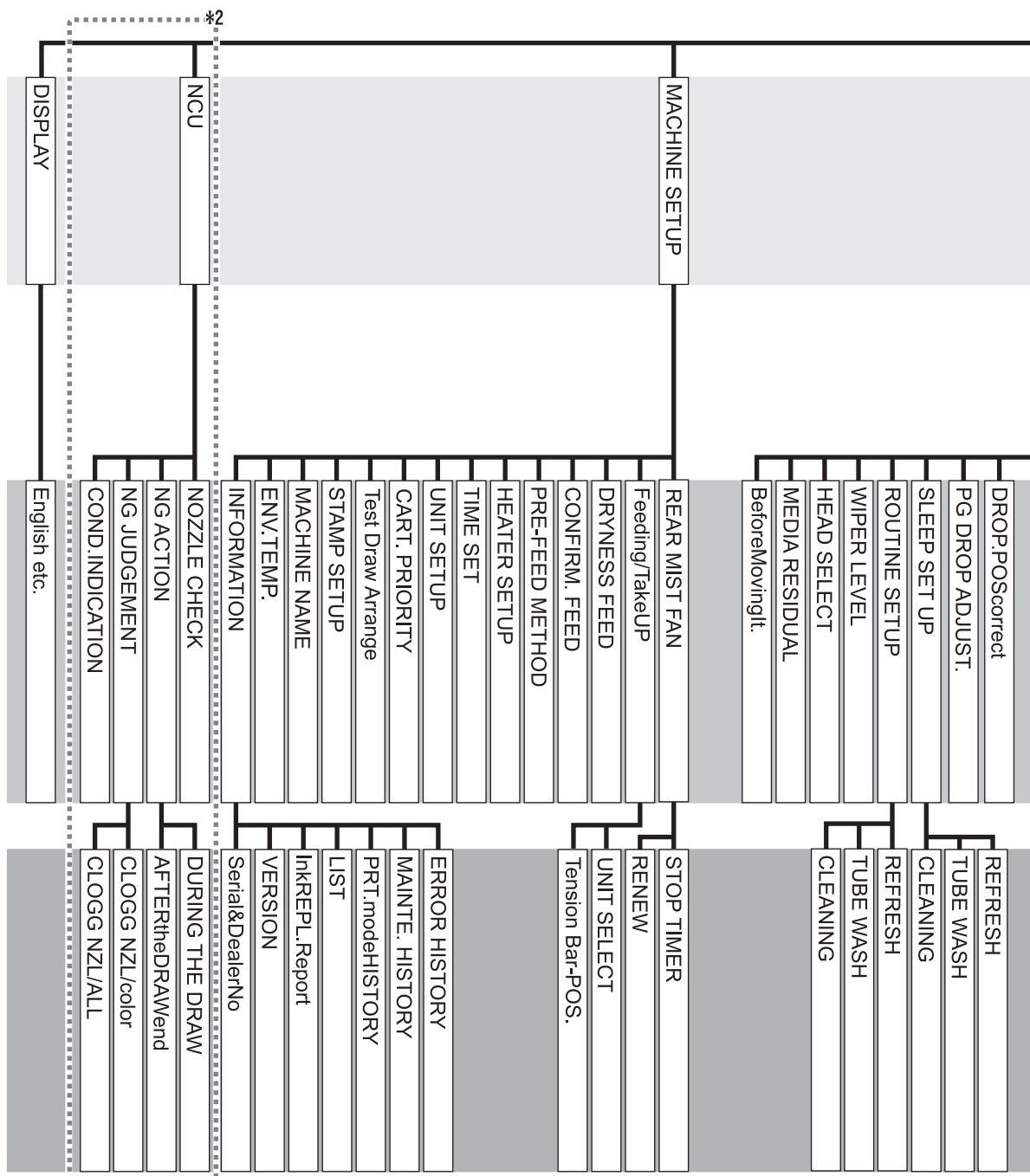

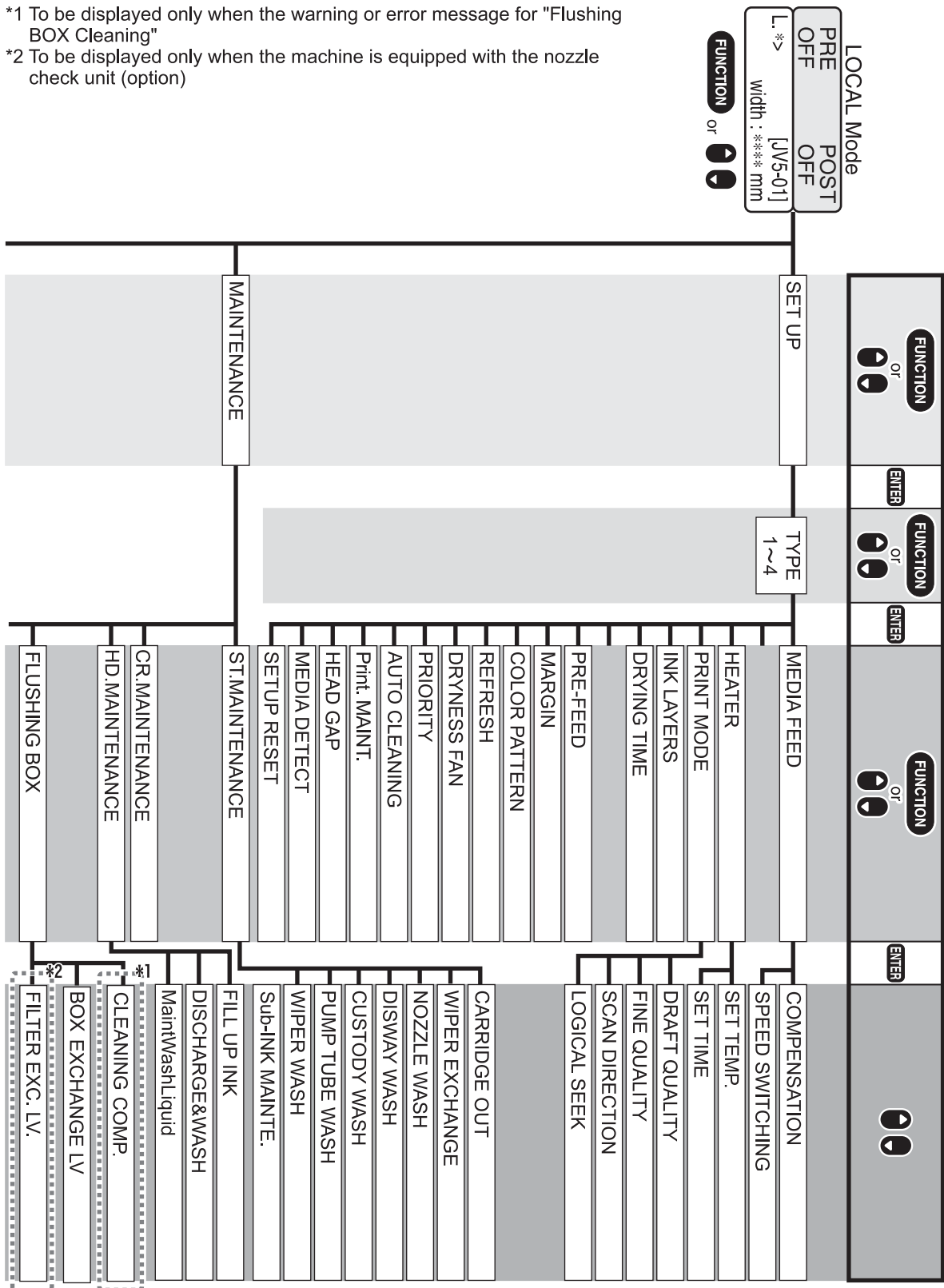

*1 To be displayed only when the warning or error message for "Flushing BOX Cleaning"

*2 To be displayed only when the machine is equipped with the nozzle check unit (option)

Direct keys

Pressing direct keys will easily invoke frequently used functions.

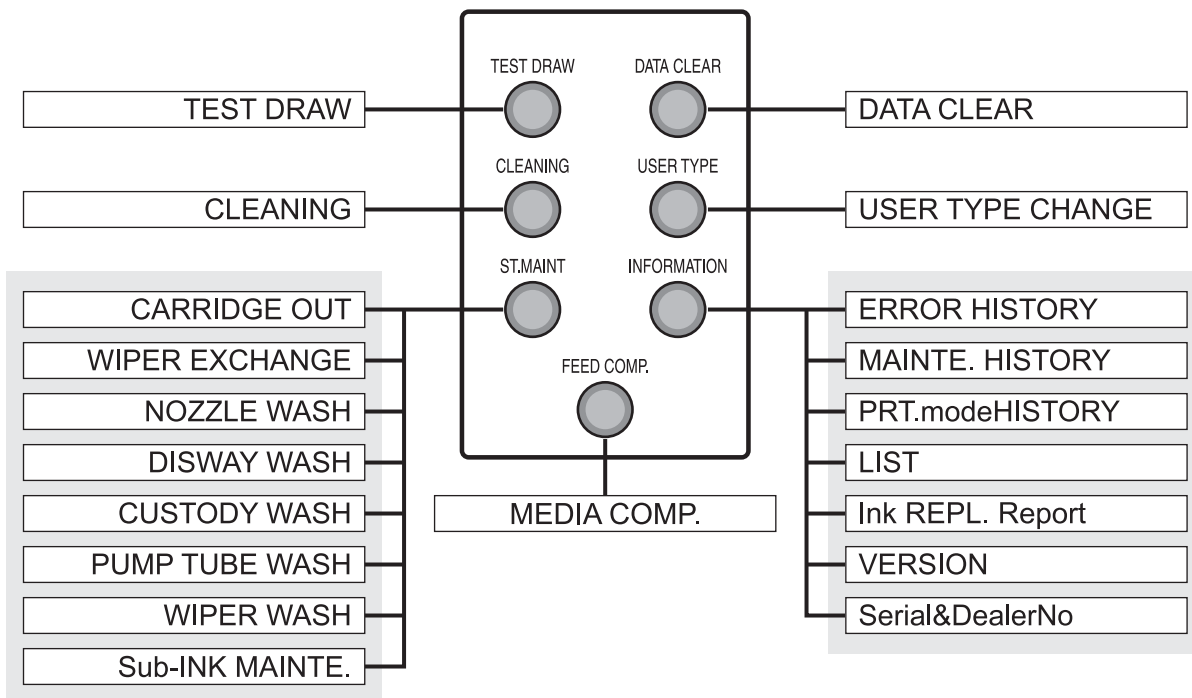

Setting values in function menus

The menus contain the following functions.

SET UP functions

Function name	Sub function		Setting value	Function
MEDIA FEED (Refer to P.6-4 in this manual.)	COMPENSATION		-255 to 255	Draws a pattern to compensate the feeding amount of the media and compensates.
	SPEED SWITCHING		200% to 10%	Sets the media feed rate.
HEATER (Refer to P.6-28 in this manual.)	SET TEMP.	Pre-heater	OFF, 20 to 60 °C (OFF, 68 to 140 °F)	Sets heater conditions.
		Post-heater	OFF, 20 to 70 °C (OFF, 68 to 158 °F)	
	SET TIME	STANDBY	(NONE, 0- 90 min / In steps of 10 minutes)	
		OFF TIME	(NONE, 0 - 90 min / In steps of 10 minutes)	
PRINT MODE (Refer to P.6-4 in this manual.)	FINE quality		STD., FINE, FAST	Sets a print quality level and printing direction.
	DRAFT quality		STD., FINE, FAST	
	SCAN DIRECTION		Uni-D Bi-D	
	LOGICAL SEEK		ON, OFF	
INK LAYERS (Refer to P.6-6 in this manual.)			1 to 9	Sets the number of layers in which ink is to be applied.
DRYING TIME (Refer to P.6-6 in this manual.)	SCAN		0.0 to 19.9 sec.	Sets the time to wait for ink drying.
	Draw.END		0 to 999 sec.	
PRE-FEED (Refer to P.6-7 in this manual.)			ON, OFF	Feeds the media back and forth before printing.
MARGIN (Refer to P.6-7 in this manual.)			-20 to 75 mm	Sets a non-printing area along the right and left edges of the media.
COLOR PATTERN (Refer to P.6-8 in this manual.)			Right edge : ON, OFF Left edge : ONx1 to ONx5, OFF	Draws a color pattern on both edges of the media.
REFRESH (Refer to P.6-8 in this manual.)			LEVEL 0 to 3	Refreshes the print heads during printing.
DRYNESS FAN (Refer to P.6-8 in this manual.)			STRONG, STANDARD, Little WEAK, WEAK, OFF	Sets the strength of the dryness fan to dehydrate ink struck through the media.
PRIORITY (Refer to P.6-9 in this manual.)	ALL HOST			Sets the priority of settings (host / panel).
	ALL PANEL			
	INDIVIDUALLY		MEDIA COMP., HEATER, PRINT MODE, INK LAYERS, DRYING TIME, PRE-FEED, MARGIN, COLOR PATTERN, REFRESH, FD.SPEED	
AUTO CLEAN-ING (Refer to P.6-9 in this manual.)	ON Press [FUNCTION] key to set items on the right.	CLEANING INTERVAL	10 to 30000 mm	Cleans the print heads automatically every completion of printing.
		CLEANING TYPE	SOFT, NORMAL, HARD	
	OFF			

Function name	Sub function		Setting value	Function
Print. MAINT. (Refer to P.6-9 in this manual.)	CLEANING Press [FUNCTION] key to set items on the right.	CLEANING INTERVAL	0.1 to 100.0 m	Cleans the print heads automatically every completion of printing.
		CLEANING TYPE	SOFT, NORMAL, HARD	
	WIPING Press [FUNCTION] key to set items on the right.	SCAN COUNT	10 to 9990 times	The heads are automatic wiped while printing.
		OFF		
HEAD GAP (Refer to P.3-2 in this manual.)			1.5 to 5.0 mm	Sets the head gap (height from the media to the nozzle plane of the heads).
MEDIA DETECT (Refer to P.6-10 in this manual.)			AUTO	Sets the method for detecting the media.
			MANUAL	
SETUP RESET				Resets the setting values to the default values.

MAINTENANCE functions



■ For functions that are not explained in detail in this manual, related items are indicated in gray.

Function name	Sub function	Setting value	Function
ST.MAINTENANCE Refer to the Chapter 4 of the JV5-320S Operation Manual.	CARRIAGE OUT (Can be selected directly by pressing [ST.MAINT] key.)		Move the carriage when cleaning the inside of the station and replacing consumables. Do not move the carriage out of the capping station by hand. Select the [ST.MAINTENANCE] - [CARRIAGE OUT] to move the carriage.
	WIPER EXCHANGE (Can be selected directly by pressing [ST.MAINT] key.)		When the display shows that the wipers must be replaced, perform this operation and replace the wipers.
	NOZZLE WASH (Can be selected directly by pressing [ST.MAINT] key.)		Washes the nozzles with a cleaning kit to correct nozzle clogging and jet deviation.
	DISWAY WASH (Can be selected directly by pressing [ST.MAINT] key.)		Washes the ink discharge passages (pump tubes) to prevent their clogging.
	CUSTODY WASH (Can be selected directly by pressing [ST.MAINT] key.)		When the operation of the printer is to be suspended for more than one week, wash the nozzles in the heads and ink discharge passages and make arrangements for storage.
	PUMP TUBE WASH (Can be selected directly by pressing [ST.MAINT] key.)		Washes the wiper.
	WIPER WASH (Can be selected directly by pressing [ST.MAINT] key.)		Washes the ink suction pumps.
	Sub-INK MAINTENANCE. (Can be selected directly by pressing [ST.MAINT] key.)		Perform this when you wish to clean the ink tray on the flushing BOX or replace the filter.
CR.MAINTENANCE Refer to the Chapter 4 of the JV5-320S Operation Manual.			Move the head unit to the left end of the printer and perform maintenance of the heads and related parts.

Function name	Sub function	Setting value	Function
HD.MAINTENANCE	FILL UP INK Refer to the Chapter 3 of the JV5-320S Operation Manual.		The heads are charged with ink. Use this function if nozzles are not unclogged by [CLEANING] and [NOZZLE WASH].
	DISCHARGE&WASH Refer to the Chapter 5 “If nozzles are still clogged even after head cleaning” of the JV5-320S Operation Manual.		Discharges ink from the heads, dampers and ink tubes, and washes them with an cleaning solution cartridge (option).
	MaintWashLiquid Refer to the Chapter 4 “Before executing the [PUMP TUBE WASH]” of the JV5-320S Operation Manual.	FILLING UP	Supplies the cleaning liquid for the wiper and pump tubes.
		DISCHARGE	Discharges the cleaning liquid for the wiper and pump tubes.
FLUSHING BOX	CLEANING COMP.		To be performed in order to let the equipment recognize that the cleaning of the flushing box has been performed.
	BOX EXCHANGE LV	5/5 to 1/5	Changes the time for cleaning or replacing of flushing box.
	FILTER EXCHANGE LV	5/5 to 1/5	Changes the time for replacing the filter on the flushing BOX. (This function is available only when the machine is equipped with the nozzle check unit (option).)
DROP.POScorrect Refer to the Chapter 3 of the JV5-320S Operation Manual.	PATTERN 1 to 4	-40.0 to 40.0 dot	Correct the difference in the ink fall points between outward trip and homeward trip. When the media thickness, head height or ink type is changed, dot positions may be slightly in misalignment. This function corrects the dot positions to ensure that the accurate printing result is obtained. Print two test patterns at the standard speed and at a high speed, respectively. Then compare the ink fall points of outward trip and those of homeward trip and correct dot positions.
PG DROP ADJUST. Refer to the Chapter 3 of the JV5-320S Operation Manual.	PATTERN 1 to 8	-40.0 to 40.0 dot	Set the reference value for correcting the misalignment of the ink fall points between outward trip and homeward trip in bi-directional printing when the head gap has been changed.

Function name	Sub function		Setting value	Function
SLEEP SET UP Refer to the Chapter 4 of the JV5-320S Operation Manual.	REFRESH	REFRESHinterval	OFF, 1 to 168 h	While the power switch is off, the printer performs refreshing operation at fixed intervals to prevent ink clogging or the like. Set the interval (in hours) at which refreshing operation that discharges ink from the heads is to be performed.
	TUBE WASH	WASH INTERVAL	OFF, 1 to 168 h	Set the interval (in hours) at which pump tube cleaning operation is to be performed.
	CLEANING	CLEAN. INTERVAL	OFF, 1 to 168 h	Set the interval (in hours) at which cleaning operation is to be performed.
		CLEAN. TYPE	Normal, Soft, Hard	Set a type of cleaning.
ROUTINE SETUP Refer to the Chapter 4 of the JV5-320S Operation Manual.	REFRESH	REFRESHinterval	OFF, 1 to 168 h	Set the interval (in hours) at which refreshing operation is to be performed.
	TUBE WASH	WASH INTERVAL	OFF, 1 to 168 h	Set the interval (in hours) at which pump tube cleaning operation is to be performed.
	CLEANING	CLEAN. INTERVAL	OFF, 1 to 168 h	Set the interval (in hours) at which cleaning operation is to be performed.
		CLEAN. TYPE	Normal, Soft, Hard	Set a type of cleaning.
	Sub-INK WARNING		OFF, 12 to 120 h	Set the interval (in hours) at which cleaning operation is to be performed to prevent color change because this machine has been left and color material has settled.
WIPER LEVEL Refer to the Chapter 4 of the JV5-320S Operation Manual.			10/10 to 1/10	The wipers are consumables. The heads can get dirty easily in a dusty atmosphere. The heads cannot be cleaned adequately with curled or worn wipers. This printer gives the wiper replacement warning earlier than standard depending on the operating environment. (10/10 = Default)
HEAD SELECT Refer to the Chapter 5 of the JV5-320S Operation Manual.			[1234] [123-], [-234] [12-], [-23-], [-34] [1-], [-2-], [-3-], [-4]	Select the head(s) to be used for printing. Any of the combinations of heads shown at left is available.
MEDIA RESIDUAL (Refer to P.6-13 in this manual.)			ON, OFF	Set ON/OFF of the media remaining amount display function. Input the media length (initial value of remaining amount) when the roll media is detected.
BeforeMovingIt. (Refer to P.6-14 in this manual.)				Use this function to lock the station when the printer is to be transported.

MACHINE SET functions

Function name	Sub function		Setting value	Function
REAR MIST FAN (Refer to P.6-17 in this manual.)	STOP TIMER		CONTINUE, 0 ~ 240mm	Sets the operation of the mist fan in the rear of the machine. [STOP TIMER] sets the time until the fan stops after drawing is completed. [RENEW] switches the current operation status of the fan.
	RENEW		ON, OFF	
Feeding / TakeUP (Refer to P.6-17 in this manual.)	UNIT SELECT	FEEDING	ON, OFF	Set whether to use or not to use heavy-duty feeding / take-up device.
		TAKE-UP	ON, OFF	
	Tension Bar-POS.		HIGH, LOW	
DRYNESS FEED (Refer to P.6-18 in this manual.)			ON, OFF	Change the feed operation after printing.
CONFIRM. FEED (Refer to P.6-18 in this manual.)	ON Press [FUNCTION] key to set items on the right.	BACK FEED	ON, OFF	Set whether or not to perform feeding the media after test printing for checking of the printing result.
	OFF			
PRE-FEED METHOD (Refer to P.6-18 in this manual.)	FORE (**mm) Press [FUNCTION] key to set items on the right.	LENGTH	10mm to 1000mm	Switches the pre-feed operation.
	FORE&BACK			
HEATER SETUP (Refer to P.6-18 in this manual.)			STD, set -5°C, set -10°C, set -15°C, set -20°C	Change the temperature range of the post-heater that determines whether the temperature is reached.
TIME SET (Refer to P.6-18 in this manual.)			ON, OFF	Set the date and time on the printer.
UNIT SETUP (Refer to P.6-19 in this manual.)	TEMP.		°C or °F	Change the units of temperature, length and area to be used with the printer.
	LENGTH		mm or inch	
STAMP SETUP (Refer to P.6-19 in this manual.)			ON, OFF	Make settings for outputting the date and time and printing conditions after printing.
CART. PRIORITY (Refer to P.6-20 in this manual.)			INK LEVEL, EXP.DATA	You can select the cartridge status to use first with the double cartridge function of ink supply.
Test Draw Arrange (Refer to P.6-20 in this manual.)			FEED DIR., SCAN DIR.	You can set the placement direction of the drawn test pattern when performing test drawing repeatedly.
MACHINE NAME (Refer to P.6-20 in this manual.)			01 to 99	When the printer is connected through the USB 2.0 interface to a system to which two or more machines are connected, set the identifier of the printer to have the system recognize it.
ENV. TEMP (Refer to P.6-20 in this manual.)			Not wait ARR., Wait arrival	Set the operation when drawing was tried to start with the temperature of the place where this machine has been installed being outside the range of usable temperature.

Function name	Sub function	Setting value	Function
INFORMATION	ERROR HISTORY (Refer to P.6-21 in this manual.) (Can be selected directly by pressing [INFORMATION] key.)	Displays the history of the errors the printer has developed up to now. Two or more errors, if any, can be displayed in turn by pressing the [▲] or [▼] key.	Display various information. The items in [INFORMATION] can be set individually by pressing the [INFORMATION] key.
	MAINTE. HISTORY (Refer to P.6-21 in this manual.) (Can be selected directly by pressing [INFORMATION] key.)	Displays the records of the maintenance function that have been executed up to now. Two or more records, if any, can be displayed in turn by pressing the [▲] or [▼] key.	
	PRT.modeHISTORY (Refer to P.6-21 in this manual.) (Can be selected directly by pressing [INFORMATION] key.)	Displays the history of information (printing conditions) of the online printing that has been performed up to now. Two or more pieces of information, if any, can be displayed in turn by pressing the [▲] or [▼] key.	
	LIST (Refer to P.6-21 in this manual.) (Can be selected directly by pressing [INFORMATION] key.)		
	Ink REPL. report (Refer to P.6-21 in this manual.) (Can be selected directly by pressing [INFORMATION] key.)		
	VERSION (Refer to P.6-22 in this manual.) (Can be selected directly by pressing [INFORMATION] key.)		
	Serial&DealerNo (Refer to P.6-22 in this manual.) (Can be selected directly by pressing [INFORMATION] key.)		

Contents

Chapter 1

Chapter 2

Chapter 3

Chapter 4

Chapter 5

Chapter 6

NCU functions



■ NCU functions are displayed only when the machine is equipped with the optional nozzle check unit (OPT-J0218).

Function name	Sub function		Setting value	Function
NOZZLE CHECK (Refer to P.6-24 in this manual.)			ON, OFF	Set whether or not to perform nozzle missing detection.
NG ACTION (*1) [DURING THE DRAW] (Refer to P.6-24 in this manual.)	CONTINUE			Set the operation of the printer to be performed during printing in case a certain level of nozzle missing is detected and thus NG judgment is made. (*2)
	CLEAN-ING&CONT	CLEANING TYPE	NORMAL, SOFT, HARD	
	CLEAN-ING&STOP	CLEANING TYPE	NORMAL, SOFT, HARD	
		RETRY COUNT	0 to 3	
STOP				
NG ACTION (*1) [AFTER the DRAWing] (Refer to P.6-25 in this manual.)	CONTINUE			Set the operation of the printer to be performed after completion of printing of one file in case a certain level of nozzle missing is detected and thus NG judgment is made. (*2)
	CLEAN-ING&CONT	CLEANING TYPE	NORMAL, SOFT, HARD	
	CLEAN-ING&STOP	CLEANING TYPE	NORMAL, SOFT, HARD	
		RETRY COUNT	0 to 3	
STOP				
NG JUDGEMENT (*1) (Refer to P.6-25 in this manual.)	CLOGG NZL/color		1 to 180	Set the number of missing nozzles per row for judging the nozzle check NG. (*2)
	CLOGG NZL/ALL		1 to 180	Set the total number of missing nozzles for judging the nozzle check NG. (*2)
COND.INDICATION (Refer to P.6-25 in this manual.)				Displays the status of the NCU. Pressing [FUNCTION] key, it displays every error that has occurred in the NCU and between NCU ↔ Main Unit. Using the [▲] or [▼] key, the errors can be displayed one by one in the order of occurrence.

CHAPTER 3

Printing



This chapter describes a series of operations and settings, ranging from power-on to end of printing.

Adjusting the head gap	3-2
Setting the media on the printer	3-3
Effective Plotting Area	3-18
Establishing the Origin	3-19
Other notes	3-20
Use method of rear surface dryness fan	3-22

Adjusting the head gap

Set the head gap (height from the media to the nozzle plane of the heads).

When the carriage is to move above the platen for printing or maintenance, it moves while keeping the head gap at the preset value.

The upper limit of the head gap varies with media thickness.

Available setting values: [1.5 mm to 5.0 mm] (in units of 0.1 mm / Default : 1.5 mm)

Important!

■ This function performs only setting the head gap; this function does not move the heads up and down.

STEPS:

1 Make sure that the printer is in LOCAL mode.

If it is in REMOTE mode, press the [REMOTE] key.

L. * > [JV5-01]
width : **** mm

2 Select [SET UP] using the [FUNCTION] key and press the [ENTER] key.

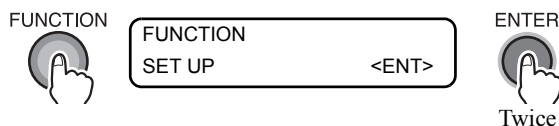

3 Select [HEAD GAP] by pressing the [▼] key 13 times and press the [ENTER] key.



4 Input a value of the head gap using the [▲] or [▼] key and press the [ENTER] key.

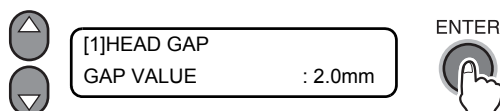

5 Press the [END] key several times.

The printer returns to LOCAL mode.

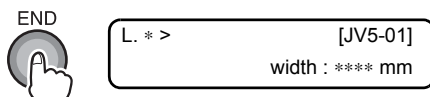

Setting the media on the printer

This printer can be used with roll media and cut sheet media. Use the media recommended by MIMAKI.
(Refer to ?Sizes of media that can be used (P.1-2)?)

Important!

- Leaf media cannot be used with this machine.
- In the cases below, be sure to fix tension-bars on both sides of the printer.
If you leave the tension-bars unfixed, the bars supported by media may fall down.
Please be careful.
 - When lifting up the clamp lever
 - When cutting media with tools you have (cutter, scissors, etc.)
- If a transparent media is set, the message [ERROR 50 MEDIA DETECT] is displayed and the media may not be detected.
- If the media is exposed to direct sunshine, the media width may not be detected correctly.
- Do not use printed media; otherwise, ink can adhere to pinch rollers and thus media may be stained or may not be detected.
- Significantly or internally curled media must be straightened so that it will be fed properly without floating above the platen.
- When setting media, make the center of the roll media match the center of the main body.
This printer can print on the media setting on the right side, however, some types of media tend to cause skew (media is fed on a skew) or sticking on the platen. By setting media in the center, the printer stably feeds the media.
- The following media cannot be used:
 - Meandering media on both edges
 - Media whose thickness is not even
 - Media whose edge is folded or whose state changed noticeably

Contents

Chapter 1

Chapter 2

Chapter 3

Chapter 4

Chapter 5

Chapter 6

Attaching/removing platen sheet metal

When using transfer paper for the media, attach the platen sheet metal.

When using fabric media, remove the platen sheet metal.

Important!

- There are two types of platen sheet metal; with or without projection. When using it, set the platen sheet metal with projection on the right side of the machine making the projection in front and set the one without projection on the left side.
- When attaching/removing platen sheet metal, hold rectangular holes (on two positions) on the platen sheet metal.
- Be careful when attaching/removing platen sheet metal so that it may not break off or bend.
- Attach/remove the platen sheet metal with the power supply OFF.
- The platen sheet metal has projection and edged part. Care should be taken when handling.

Attach the platen sheet metal

When using sublimation transfer paper, attach the platen sheet metal.

There are two types of platen sheet metal; platen sheet metal R with projection and platen sheet metal L without projection.

Important!

- When attaching, while holding rectangular holes on two positions, attach the platen sheet metal R quietly so that you may not break off or bend it.

Platen sheet metal R

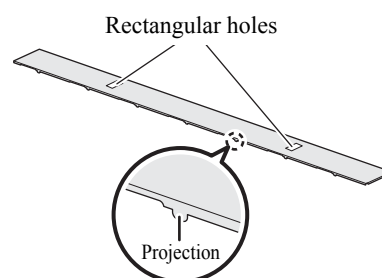

1 Prepare the platen sheet metal R and attach it quietly with making projection in front.

Attach the platen sheet metal R on the right side of the machine.

Set the platen sheet metal R so that its projection enters into the hole of the platen sheet metal holder located in the center of the machine.

2 Attach the platen sheet metal L.

Attach the platen sheet metal L aligning it with the left edge of the platen sheet metal R.

The platen sheet metal L has no projection. When attaching it, it does not matter either side is in front.

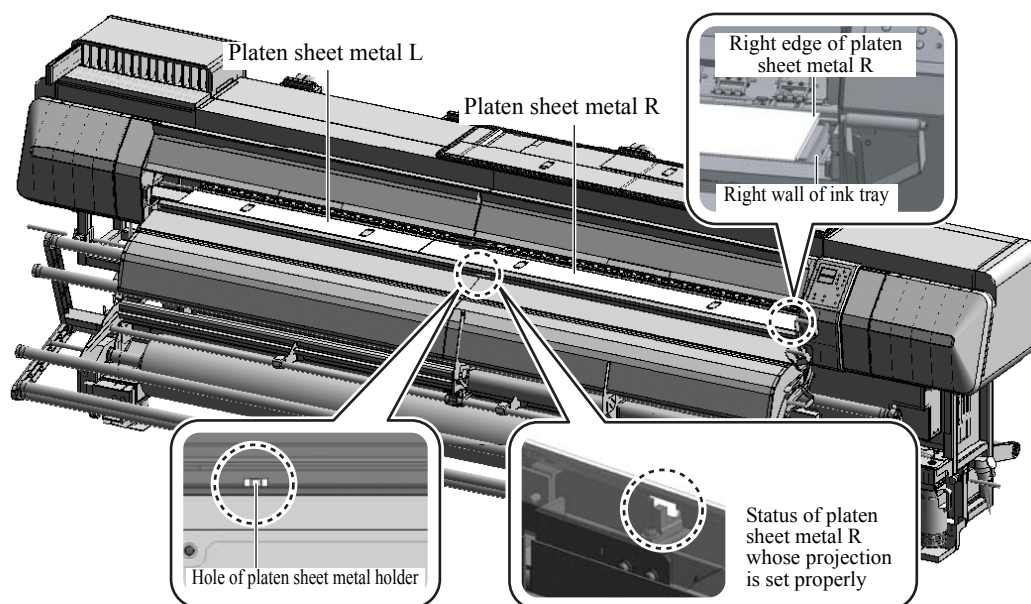

3 Check that the height of the platen sheet metal is same as that of the platen sheet metal holder.

If the platen sheet metal is higher, the reasons may be:

- The platen sheet metal is placed on the screw of the platen sheet metal holder.
- The projection of the platen sheet metal R does not enter into the hole of the platen sheet metal holder.

In the above cases, attach the platen sheet metal again.

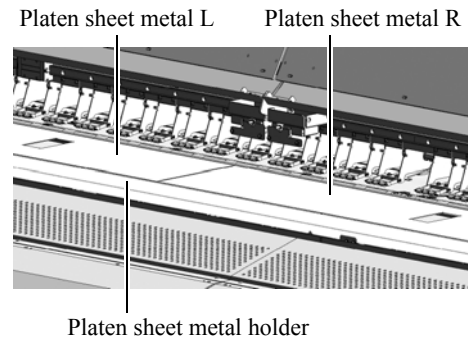

Remove the platen sheet metal

1 Hold rectangular holes on two positions on the platen sheet metal concurrently and remove it quietly.

2 Wipe ink blot adhering on the removed platen sheet metal with soft cloth or paper towel.

If ink blot adheres to the platen sheet metal, wipe ink blot with paper towel immersed in cleaning liquid for maintenance.

3 Place the platen sheet metal (L/R) on the platen sheet metal storage located on the machine and store them.

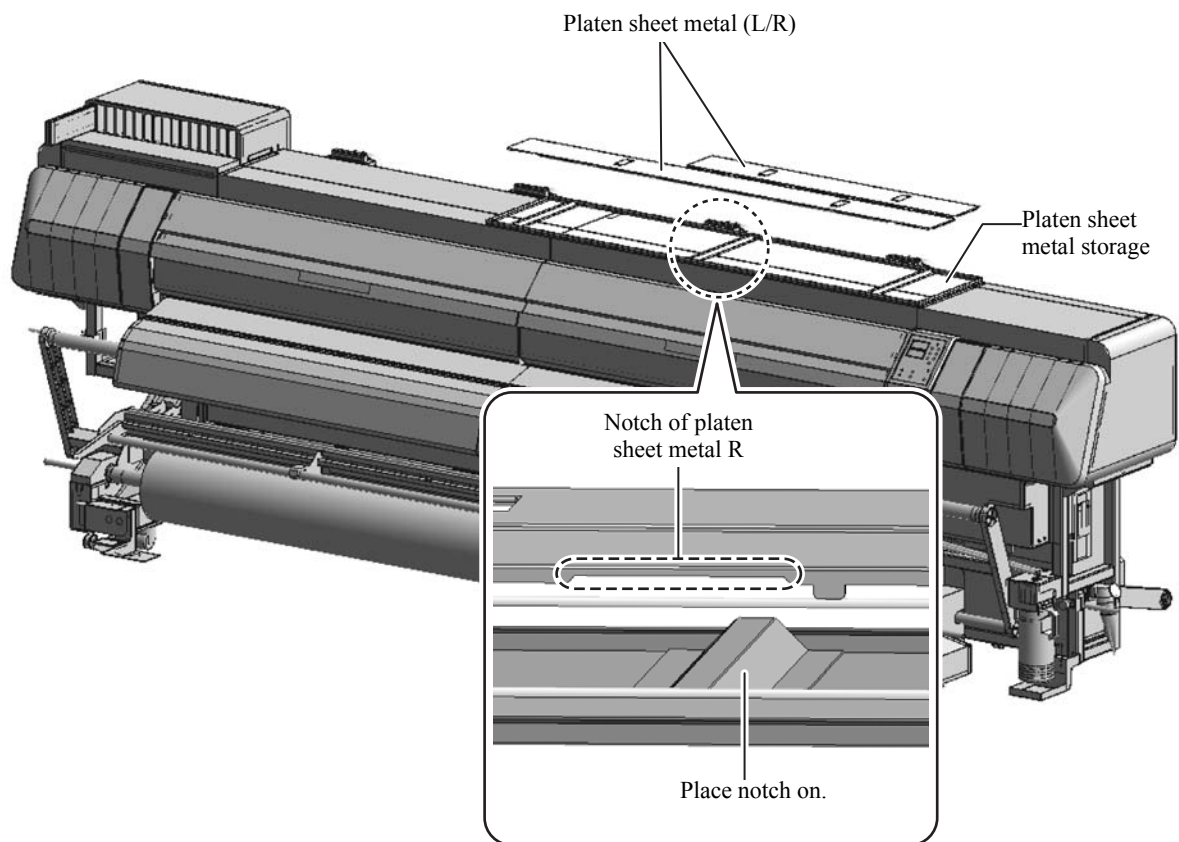

Setting position for fabric media

When setting fabric media (platen sheet metal is not used), be careful about the setting position for the media.

Depending on the setting position for the media, the media press cannot be used.

Important!

- A black and white label is pasted on the rear of this machine (back of heavy media feeding machine) (media setting position NG label).
Do not put the edge surface of the media into the black area of this label.
- If the edge surface of the media is in this area, move the media to right and left to adjust it so that the edge surface of the media comes outside the area.

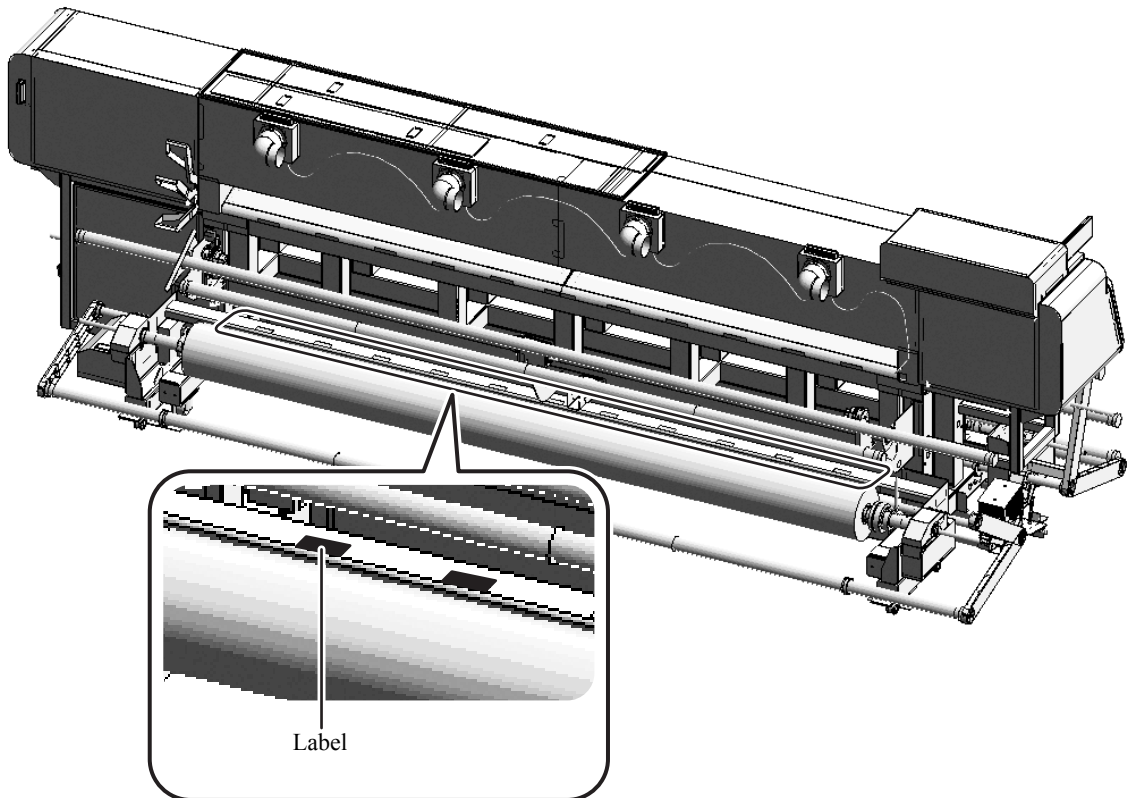

Setting media

When setting media, use the heavy media feeding/take-up machine.

Important!

- When setting media, be sure to set the media press on the proper position.
- The media press of this machine also functions as the detection plate to detect the media width. If the media press is not set on the proper position, the media width cannot be detected properly.
- When setting media using heavy media feeding/take-up machine, drawing cannot be performed on the front edge (about 2000mm) and the rear edge (about 1500mm).
- Set the media so that the center of the roll media matches the center of the main body.

Set the media by following procedures below:

No.	Operation Outline
[1]	<p>Check the platen sheet metal (Refer to P.3-4 in this manual.)</p> <p>Attach the platen sheet metal depending on the type of the media to be used. Before attaching platen sheet metal, be sure to turn OFF the power supply.</p>
[2]	<p>Set a paper core to the take-up side (Front of the printer) (Refer to the JV5-320S Operation Manual.)</p> <p>Set paper core for media on the heavy-duty take-up device on the front of the printer.</p>
[3]	<p>Set a media to the feeding side (Back of the printer) (Refer to the JV5-320S Operation Manual.)</p> <p>Set a media on the heavy-duty feeding device on the back of the printer.</p> <div style="border: 1px solid black; padding: 5px; margin-top: 10px;">  <p>■ Before setting a media, be sure to clean the ink tray. If ink remains in the ink tray, the media may be blotted. (☞ P.4-6 “Cleaning of ink tray/ink tray sheet metal”)</p> </div>
[4]	<p>Adjust the media (Refer to P.3-8 in this manual and the JV5-320S Operation Manual.)</p> <p>Adjust the media to start printing.</p>
[5]	<p>Adjust the counter weight (Refer to P.3-12 in this manual.)</p> <p>To make the media has best suited tension and to perform stable take-up, attach the counter weight.</p>
[6]	<p>Set the media press (Refer to P.3-13 in this manual.)</p> <p>Set the media press on both edges of the media.</p>
[7]	<p>Detect the media width (Refer to P.3-10 in this manual and the JV5-320S Operation Manual.)</p> <p>This manual explains unique operation for JV5-320DS.</p>

[4] Adjust the media (Supplementation/ notes)

Procedures for fixing media on heavy media take-up machine

Important!

■ When fixing media on the paper core, use adhesive tape etc. and pay attention to the next points to avoid folds:

- Make intervals of adhesive tape within 500mm.
- Pulling the media straight to the take-up direction, paste it so that the media on the ink tray has no surface waviness (if the media has surface waviness, paste it again).

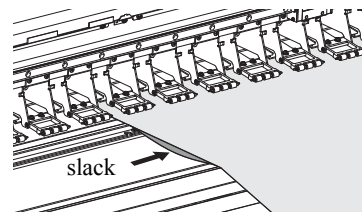

Fixing method when taking up outward

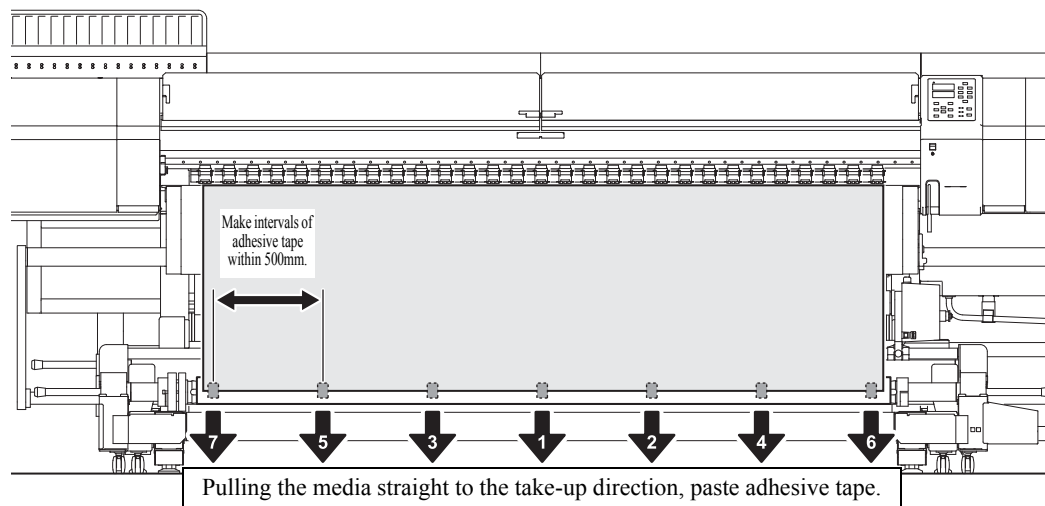

Fixing method when taking up inward

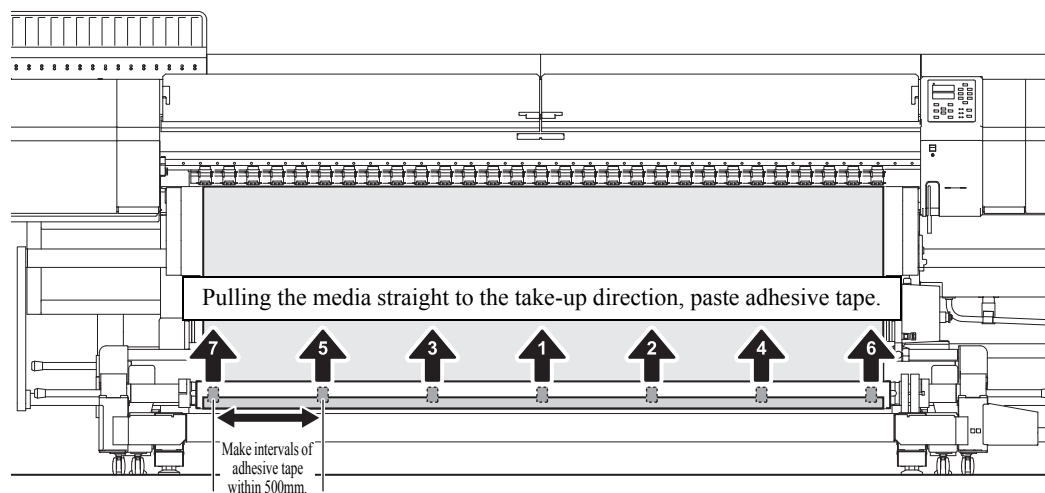

Notes when feeding fabric media

If the set fabric media is fed in the status without tension on both in front and in the rear, the media may entwine the feeding roller.

When feeding fabric media, perform the work putting tension on the fabric media by holding with your hand.

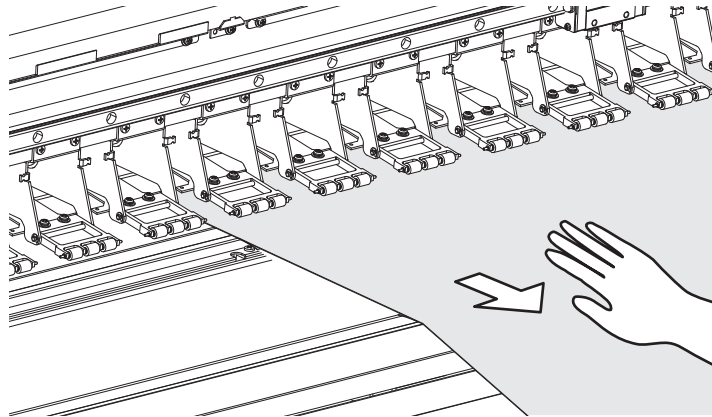

Number of take-up times to paper core set on heavy media take-up machine



- After pasting media on the paper core, loop the media twice using the switch of the heavy media take-up machine.
For details of looping method, refer to the “JV5-320S Operation Manual”.

Setting method of media press

The media press of the JV5-320DS differs from that of the JV5-320S.

Set the media press depending on the media to be used. (☞ P.3-13 “[6]Set the media press”)

If the media cannot be detected automatically

In some cases, the media cannot be detected automatically depending on the set media. In this case, detect the media by following procedures below:

STEPS:

1 Set the “MEDIA DETECT” in the setting function to “MANUAL”.

Set this by referring to P.6-2.

2 Start detecting media by pressing the [END] key.

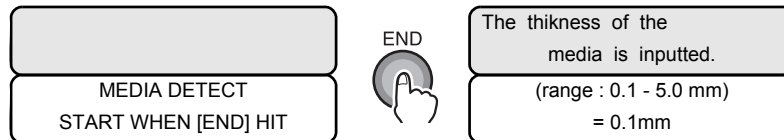

3 Press the [▲] or [▼] keys to enter the thickness of the set media and then press the [ENTER] key.

You can enter values from 0.1 to 5.0 mm.

When the [MEDIA DETECT] in the setting mode to “AUTO”, entering the thickness of the media starts detecting media. (After detecting media, it returns to the local mode.)

When the [MEDIA DETECT] in the setting mode to “MANUAL”, proceed to the Step 4.

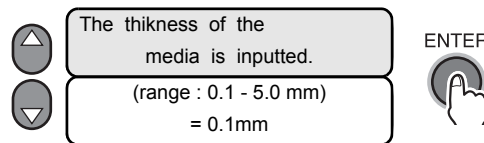

4 Press the [▲] or [▼] keys to enter the width of the set media and then press the [ENTER] key.

You can enter values from 210 to 3300 mm.

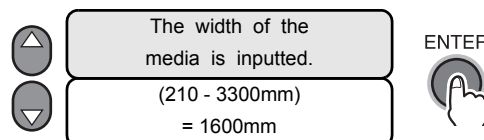

5 Press the [◀] [▶] keys to move the carriage to the right edge of the media and press the [ENTER] key.

Align the drawing origin arrow of the head cover with the right edge of the media.

Press the [ENTER] key to determine the right edge of the media.

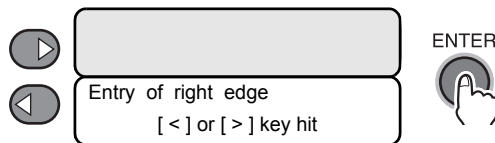
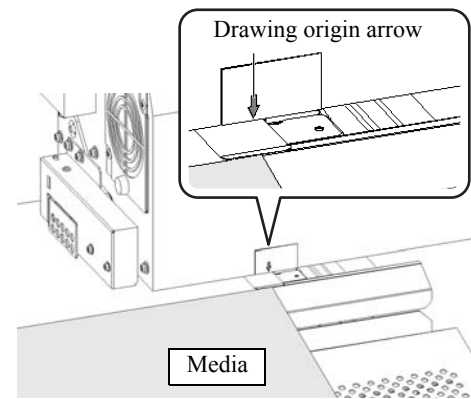

6 Press the [▶] key to terminate the media detection.

Determining the right edge of the media sets the left edge of the media automatically.

(The position moving to the left from the right edge of the media by the media width entered in the Step 4 will become the left edge.)

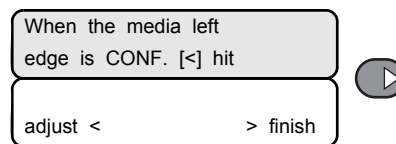

■ In the Step 6, you can fine adjust the media left edge position.

1. Press the [◀] key in the Step 6.
2. Press the [◀] [▶] keys to move the carriage to the left edge of the media.
3. Align the drawing origin arrow of the head cover with the left edge of the media.
4. Press the [ENTER] key to determine the media left edge position.

[5] Adjusting the counter weight

To keep the proper tension of the media and to take up stably, attach the counter weight to the take-up tension bar and the feeding tension bar after setting media. Please note that the counter weight attached may slack off the media on the ink receiver and soil the media.

Important!

- By the counter weight, the tension bar lightens and media feeding improves. Attach the counter weight as many as possible.
- A heavy tension bar may affect media feeding.
- The counter weight weighs about 1 kg per one. Attach it with care.

Attach the counter weight to the take-up tension bar and the feeding tension bar.

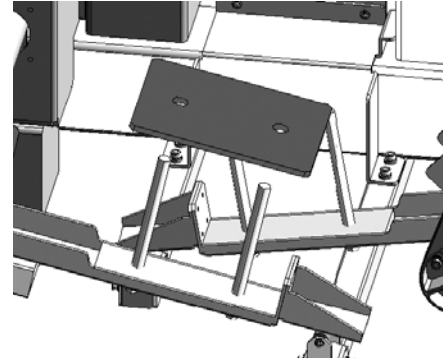

Adjust the number of the counter weight, confirming the media condition.

- Take-up side (as a guide): Attach so that media on the ink receiver does not slack (maximum number which can be attached).
- Feeding side (as a guide): Attach so that media does not wrinkle (maximum number which can be attached).



OK



The media on the ink receiver is slack. Adjust it.



OK

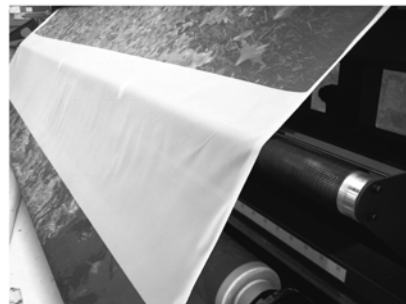

The media has wrinkles. Adjust it.

[6]Set the media press

This machine has two types of media press depending on the media type.

Important!

- The media press is very edged. Be careful about its handling.
- When setting media, be sure to set the media press on the proper position.
- The media press of this machine also functions as the detection plate to detect the media width. If the media press is not set on the proper position, the media width cannot be detected properly.
- When using thick media (of 0.5 mm and above), do not attach the media press. In this case, the automatic detection of the media cannot be performed. Detect the media referring to P.3-10 "If the media cannot be detected automatically".

For fabric media

1 Prepare the media press for fabric media.

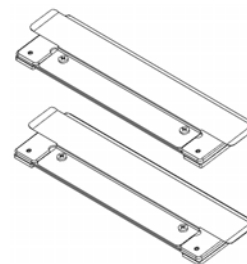

2 Paste the media press on both edges of the media.

Make arrow marks on the media press matches the edge surface of the media.

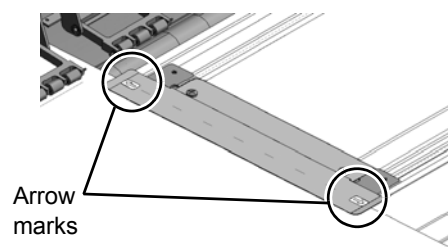

Important!

- If there is a screw on the position on which you wished to paste the media press and if you paste the media press as it is, the media press will be lifted.
- If the pasted media press is lifted, set the media again (adjust it by moving setting position of the media to right and left).
- To set the media on the proper position, refer to P.3-6 "Setting position for fabric media".

For transfer paper

1 Prepare the media press for transfer paper.

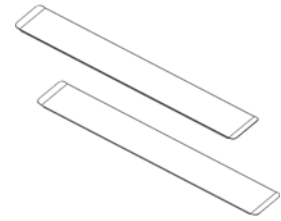

2 Paste the media press on both edges of the media.

Make arrow marks of the media press match the edge surface of the media.

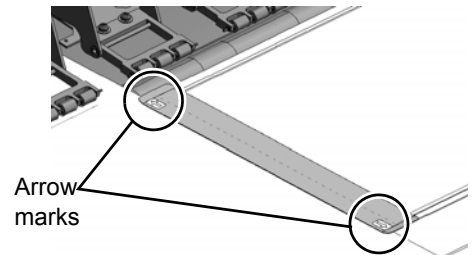

Setting the media using the roll holder



- Roll holder is ancillary. It is not suitable for continuous drawing on long media/ for long hours or for wide width/heavy media. Basically, use the heavy media feeding/take-up machine.
- Be careful not to drop the media on your foot etc.
- When setting media using roll holder, drawing cannot be performed on the front edge and the rear edge (about 800mm).



- When setting media, be sure to set the media press on the proper position.
- The media press of this machine also functions as the detection plate to detect the media width. If the media press is not set on the proper position, the media width cannot be detected properly.

Set roll media as following workflow.

No.	Operation Outline
[1]	<p>Check the platen sheet metal (Refer to P.3-4 in this manual.)</p> <p>Attach the platen sheet metal depending on the type of the media to be used. Before attaching platen sheet metal, be sure to turn OFF the power supply.</p>
[2]	<p>Set media to the back roll holder (Refer to the JV5-320S Operation Manual.)</p> <p>Set media to the feeding device on the back of the printer, and pull the media out of the front.</p>
[3]	<p>Set media to the front roll holder (Refer to the JV5-320S Operation Manual.)</p> <p>Set the take-up device on the front of the printer, and set media.</p>
[4]	<p>Set the media press (Refer to P.3-13 in this manual.)</p> <p>Set the media press on both edges of the media.</p>
[5]	<p>Detect the media width (Refer to P.3-10 in this manual and the JV5-320S Operation Manual.)</p> <p>This manual explains unique operation for JV5-320DS.</p>

When [MEDIA RESIDUAL] of [MAINTENANCE] function has been set to ON

STEPS:

1 Detection is completed, and the carriage returns to the station.

2 Input a value of the media length using the [▲] or [▼] key and press the [ENTER] key.

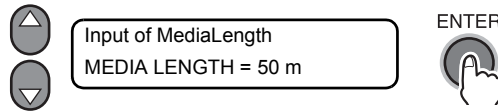

3 However, only press the [END] key when the value to be input is identical with the previously input value.

Initial value: 50 m; Input range: 1 m to 500 m (in units of 1 m)

4 The printer returns to LOCAL mode.

How to operate the take-up device

The take-up device is equipped with a switch that selects the direction in which the media is to be wound.

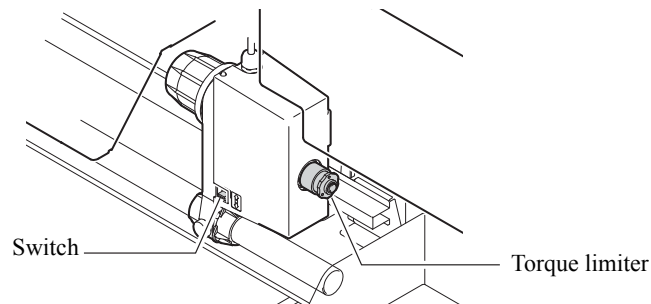

Notes on media edge surface and pinch roller

If you press the media edge surface with the pinch roller when you moved down the clamp lever, the media may not be fed properly.

If the pinch roller is on the media edge surface, make the pinch roller on the media edge surface be lifted using the attached clamp fixing spacer (x 30).

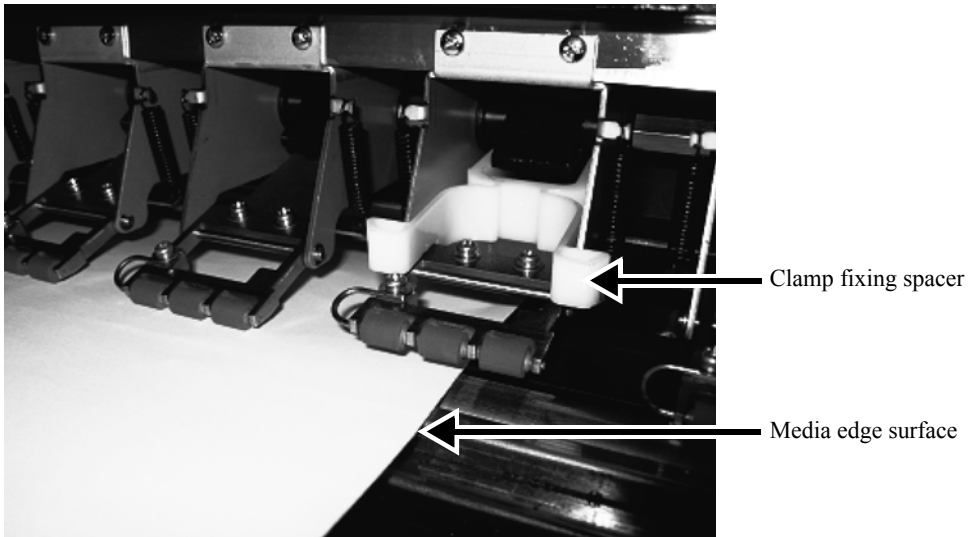

Effective Plotting Area

The printer has an area where printing is not permitted, for mechanical reasons. This area is called “non-printing area”.

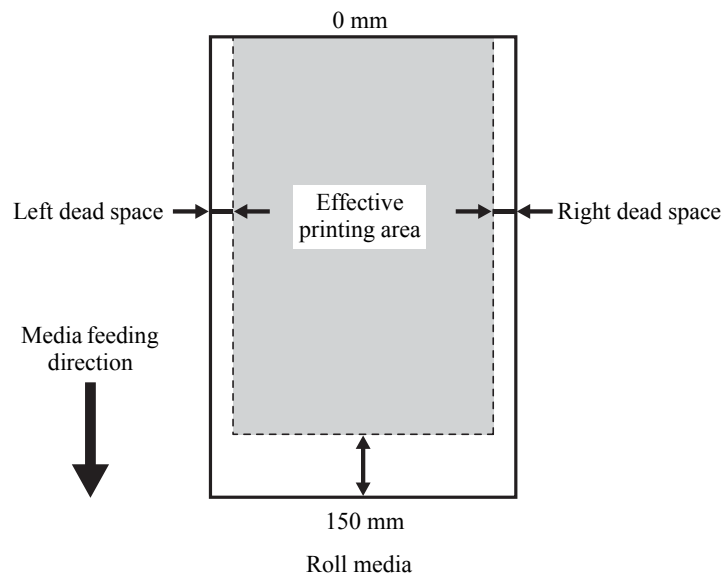

- **The default value of dead spaces in the right and the left differs depending on the media detection method or the media type to use.**

Use the following value as reference:

<When printing on fabric>

Automatic media width detection: "71 mm" from media press

Manual media detection : "40 mm" from media edge surface

<When printing on paper>

Automatic media width detection: "49 mm" from media press

Manual media detection : "25 mm" from media edge surface

- **You can change these dead spaces and effective drawing area. Set the margin with “Margin” in the function mode.**

Margin

This function adjusts the right and left margins of the media.

Use this function when margins other than 25 mm, which is the standard margin, are required.

Dead spaces can be set on both in the right and the left respectively (-20 to 75 mm).

Establishing the Origin

Establish the origin for printing the data on the media loaded on the printer.

When printing requires an area other than that defined by the established origin, set the origin at another point by following the origin setting procedure again.

STEPS:

- 1 Once the media detection is completed, move the carriage and media using the JOG keys [▲], [▼], [◀] and [▶] so that the carriage is located at the position where the origin is to be established.

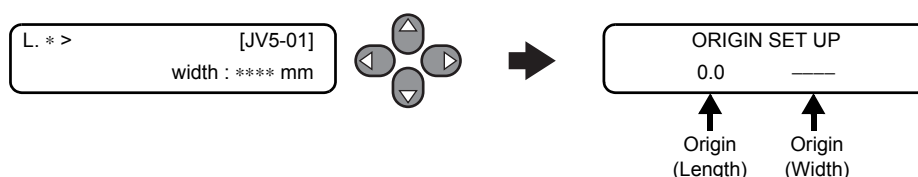

- 2 After determining the origin, press the [ENTER] key.

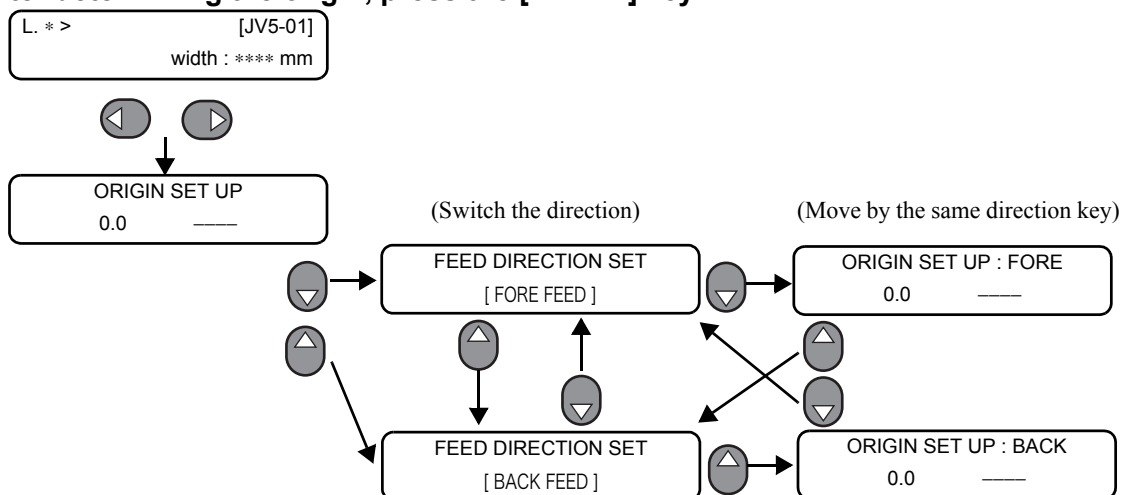

- When moving the origin to the back of the media, switch the moving direction as follows.

The printer displays the effective printing area, and then returns to LOCAL mode. (When the roll media is used, the value in X direction is not displayed.)

From the time the printer starts next printing, it uses the origin that has been established here unless the origin is newly established at another point.



Other notes

Handling of media after drawing

The drawn media will be taken up with the take-up machine located in the rear of the machine. If the media taken up will be left on the floor etc. for long hours as it is in roll status, it may set off due to the media's own weight.

When you store the media in roll status, be careful so that the printing part can be lifted as described below.



Status of printing part being lifted



Status of printing part being left on the floor etc.

When cutting media

After drawing, if you wish to cut the media with scissors etc., be careful about the following point:



■ If you cut the media with scissors etc., the media may drop into the ink tray and be blotted. When cutting media, follow the procedures below:



1. Feed the printing part from the cut groove to the take-up machine side manually.
2. Return the tension bar to the waiting position and cut the media on the cut groove located on the dryness fan.
 - Cut it using scissors etc.



3. Cut the feeding side in the rear of the machine in the same way.
 - Return to the tension bar to the waiting position and cut it in front of the Pre heater.



4. Release the clamp and remove the media remaining on the platen surface.
 - The media remaining on the platen surface is blotted with ink in the ink tray. When removing media, pay fully attention not to blot your hand.

Use method of rear surface dryness fan

When drawing on the fabric media, ink broke through to the rear side of the media may impact on the drawing surface after take-up because ink does not get dry. In this case, use the rear surface dryness fan to dehydrate ink on the rear surface.

Important!

■ If you use the rear surface dryness fan, the media may be lifted.

You can avoid the media from being lifted by using the heavy media feeding/take-up machine, or adjusting the strength of the fan.

STEPS:

1 Make sure that the printer is in LOCAL mode.

If it is in REMOTE mode, press the [REMOTE] key.

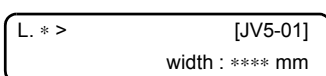

2 Select [SET UP] using the [FUNCTION] key and press the [ENTER] key. Select type 1 to 4 and press the [ENTER] key.



3 Select [DRYNESS FAN] by pressing the [▼] key and press the [ENTER] key.



4 Press the [ENTER] key to proceed to the lower hierarchy and with the [▲][▼] keys, set the strength of the dryness fan.

After setting the strength of the dryness fan, register it with the [ENTER] key.



5 Press the [END] key several times to return to LOCAL mode.

CHAPTER 4

Daily Care



This chapter describes the recovery procedure for ink clogging and the cleaning procedure for each section.

Routine Maintenance	4-2
Replace the filter of exhaust fan in the rear	4-3
Replace the filter of the slider fan.	4-4
Cleaning of ink tray/ink tray sheet metal	4-6

Routine Maintenance

Notes on cleaning solution

Use the cleaning liquid dedicated for the ink being used.

Sublimation transfer ink	Cleaning Liquid Bottle Kit A29 (SPC-0137) [Sold separately] Water-based Cleaning Liquid Cartridge (SPC-0259) [Sold separately]
--------------------------	---

Cleaning of platen sheet metal/platen sheet metal holder

Wipe dust on the platen sheet metal with soft brush, dry cloth or paper towel.

If ink blot adheres to the platen sheet metal, wipe it with paper towel immersed in cleaning liquid for maintenance.



- When cleaning, if you wish to move the platen sheet metal on the machine, check that there is no ink adhering to the platen sheet metal. If there is ink blot, wipe it off.
- Wipe softly the platen sheet metal when cleaning so that it may not be broken or bent.
- When moving the platen sheet metal, hold rectangular holes (on two positions) at the same time.

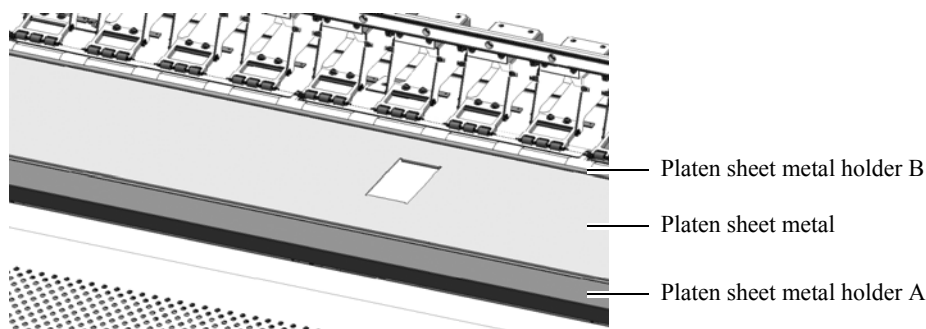

Cleaning the media sensor (2 places)

Remove ink blot or dust adhering to the sensor surface with a cotton swab.

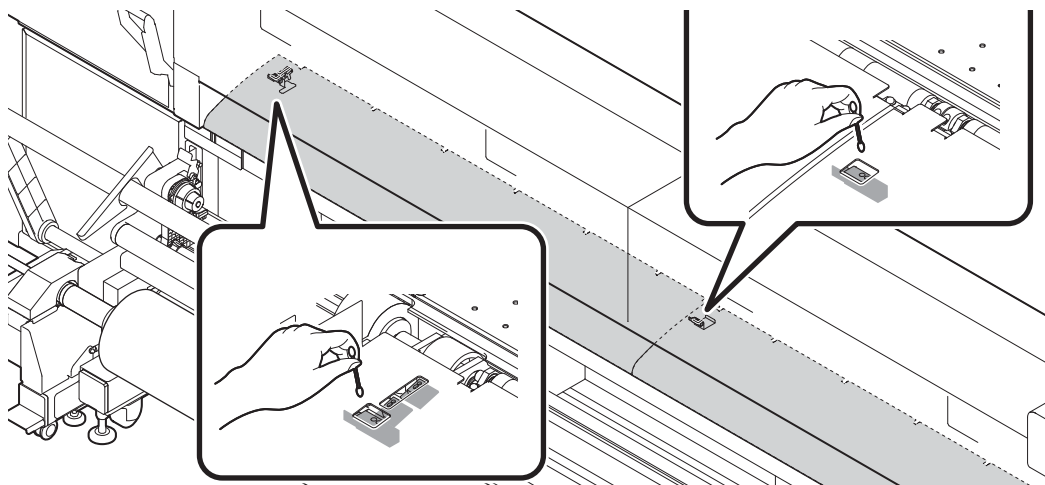

Replace the filter of exhaust fan in the rear

To maintain the drawing quality, replace the filter of exhaust fan in the rear periodically. (SPC-0629/ exhaust fan filter set [sold separately])

It is recommended to replace the filter per 1000m² drawing.

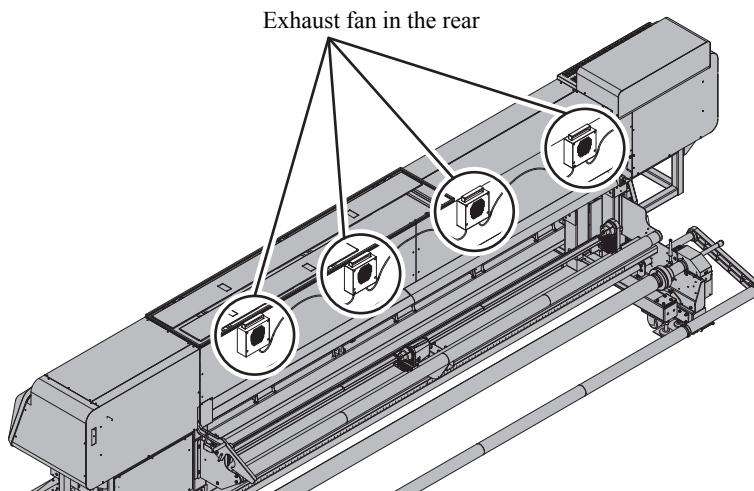

Important! ■ Replace the filter after checking the carriage stops.

STEPS:

1 Pull the filter Assy out.

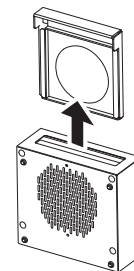

2 Remove the filter press and replace the filter inside.

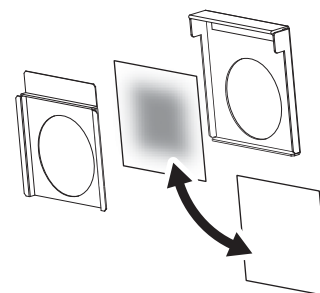

3 Return the filter Assy to the original status and insert it into the exhaust fan in the rear.

Replace the filter of the slider fan.

Replace the filter periodically to maintain the performance of the slider fan.
(SPC-0630/head fan filter set [sold separately])

It is recommended to replace the filter per 1000m² drawing.



■ The slider fan is located on both sides of the carriage. When replacing, replace both filters.

STEPS:

1 Make sure that the printer is in LOCAL mode.

If it is in REMOTE mode, press the [REMOTE] key.

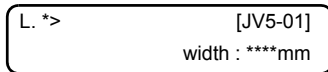

2 Press the [ST.MAINT] key and press the [ENTER] key.

When [CARRIAGE OUT] is displayed, press the [ENTER] key. Then the carriage moves to above the platen.

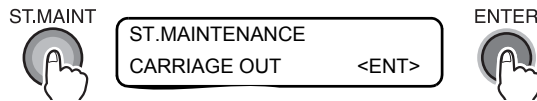

3 Open the front cover.

4 Remove the knurled screws fixing the filter (two positions for one side).

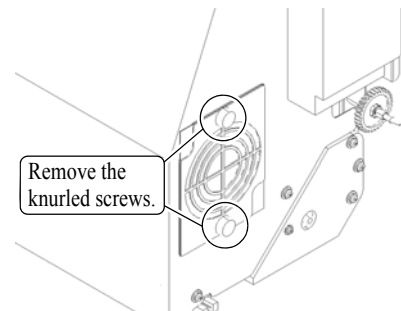

5 Replace the filter located between the filter plates.

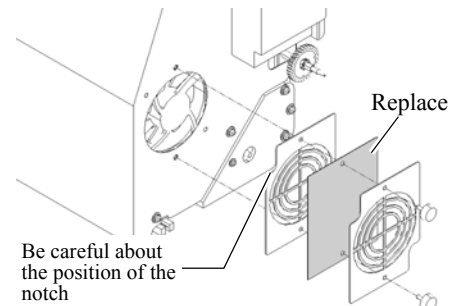

6 Fasten the knurled screws fixing the filter.

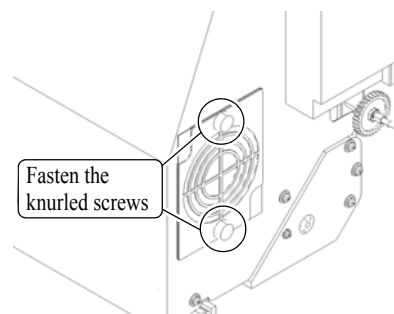

Important!

■ Be careful about the attaching direction of the filter plate.
If the direction is wrong, you cannot fasten it with the knurled screws.

7 Close the front cover, and press the [ENTER] key.

After performing the initial operation, the printer returns to LOCAL mode.



Cleaning of ink tray/ink tray sheet metal

Clean the ink tray and the ink tray sheet metal when replacing media.

STEPS:

- 1 Wipe the ink tray and the ink tray sheet metal to the direction indicated with an arrow.**

If ink is hardened, wipe with paper towel immersed in cleaning liquid for maintenance.

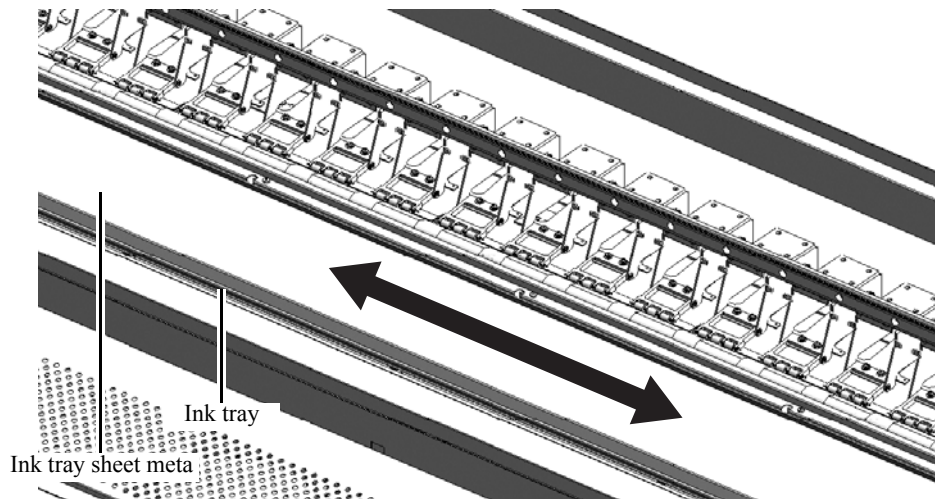

CHAPTER 5

In Case of Trouble



This chapter describes the actions to be taken when the printer develops any trouble.

Warning errors newly added	5-2
Error messages newly added	5-2

Warning errors newly added

Here, warning messages that are newly displayed in the JV5-320DS are explained.
For other warning messages, refer to the JV5-320S Operation Manual.

Warning message	Cause	Remedy
! NearExcg. FboxFILTER *1	Time to replace the filter of the flushing BOX is coming soon.	Replacing the filter is recommended.

*1. Only when the machine is equipped with the nozzle check unit (option), this warning is displayed.

Error messages newly added

Here, error messages that are newly displayed in the JV5-320DS are explained.
For other error messages, refer to the JV5-320S Operation Manual.

Error message	Cause	Remedy
**** ERROR 145**** F.BOX FILTER EXCHAG *1	Time to replace the filter on the flushing BOX has come.	Replace the filter as soon as possible.
**** ERROR 215 **** PLATEN	During the power supply is ON, there occurs an error in the platen equipped status.	Check whether the platen is lifted or not due to loose screw. Turn off the power to the printer and turn it on after a while. If the same error message appears again, contact your local distributor to call for service.

*1. Only when the machine is equipped with the nozzle check unit (option), this error is displayed.

CHAPTER 6

Operation for Functions



This chapter describes the operating procedure for frequently used functions from the printer function menu, showing sample messages on the display.

Functions Invoked by [FUNCTION] Key	6-2
Invoking SET UP functions	6-2
Invoking MAINTENANCE functions	6-11
Invoking MACHINE SETUP functions	6-15
Invoking NCU functions	6-23
DISPLAY setting	6-26
Applied settings of functions	6-27
How to operate function menus	6-30
Functions related to print quality	6-31
Functions related to ink	6-32
Function Flowchart [BOOT]	6-34
Function Flowchart [LOCAL mode]	6-36
Function Flowchart [REMOTE mode]	6-40
Function Flowchart [FUNCTION Key]	6-42

Functions Invoked by [FUNCTION] Key

The following five types of functions can be invoked by pressing the [FUNCTION] key.

Function name	Description	Page in this manual
SET UP	Make various settings concerning print quality.	P.6-2
MAINTENANCE	Maintenance functions are to be executed to keep the printer in good condition.	P.6-11
MACHINE SETUP	Display various information of the printer or set time or units of measure.	P.6-15
NCU *1	Set operations concerning the nozzle missing detection function.	P.6-23
DISPLAY	Set a language to be used with the printer.	P.6-26

*1. "NCU" can be used only when the optional nozzle check unit (OPT-J0218) is mounted.

Invoking SET UP functions

Registering printing conditions in a lump (type registration)

FUNCTION mode provides 16 setup functions.

The setting value of each of the 15 functions other than SETUP RESET can be registered as any of the following four types.

If the types are registered for different kinds of media, respectively, printing conditions can be easily changed when the media is replaced with another kind of media.

Type 1	Media 1 for soft sign
Type 2	Media 2 for soft sign
Type 3	Transfer paper 1
Type 4	Transfer paper 2

Example of type registration

List of functions

This section describes briefly the setup functions and their setting values.

Name	Function	Page in this manual
MEDIA FEED.	Corrects the feed rate of media	P.6-4
HEATER	Sets heater conditions	P.6-4
PRINT MODE	Sets a print quality level and printing direction	P.6-4
INK LAYERS	Sets the number of layers in which ink is to be applied	P.6-6
DRYING TIME	Sets the time to wait for ink drying	P.6-6
PRE-FEED	Feeds the media back and forth before printing	P.6-7
MARGIN	Sets a non-printing area along the right and left edges of the media	P.6-7
COLOR PATTERN	Draws color patterns on both edges of the media.	P.6-8
REFRESH	Refreshes the print heads during printing	P.6-8

Name	Function	Page in this manual
DRYNESS FAN	Sets the strength of the fan to dehydrate ink broke through to the rear surface.	P.6-8
PRIORITY	Sets the priority of settings (host / panel)	P.6-9
AUTO CLEANING	Cleans the print heads automatically every completion of printing	P.6-9
Print. MAINTE	Automatically cleans or wipes the heads regularly while printing.	P.6-9
HEAD GAP	Sets the head gap (height from the media to the nozzle plane of the heads).	P.6-10
MEDIA DETECT	Sets the media width detection method (MANUAL/AUTO).	P.6-10
SETUP RESET *1	Resets the setting values to the default values	P.6-10

*1. Each item excluding [SETUP RESET] can be registered on the type.

Settings of the setup functions

The operation described below on the operation panel is required to execute the setup functions.

STEPS:

1 Make sure that the printer is in LOCAL mode, and then select [SET UP] using the [FUNCTION] key and press the [ENTER] key.

If it is in REMOTE mode, press the [REMOTE] key.



2 Select an appropriate one of Type 1 to Type 4 by means of [▲] or [▼], and press the [ENTER] key.

Set the printing conditions.



3 Select a setup function and make setting.

Outline of the setup functions

MEDIA FEED

Set particulars related to media feed.

The table below shows the setting items.

COMPENSATION	Compensates the feeding amount of the media.
SPEED SWITCHING	Sets the media feed rate.

COMPENSATION

Compensates the feeding amount of the media when you replaced the media type or when you changed the heater temperature without fail.

Available setting values: [-255 to 255]

SPEED SWITCHING

Set the feed speed level.

Available setting values: [200% ~ 10%]

The setting values for each user type are stored separately from those for other user types.

HEATER (See P.6-28)

Make settings of the pre-heater and post-heater built in the platen.

PRINT MODE

Sets various conditions of printing.

DRAFT quality

Set a desired print quality in DRAFT mode (540 dpi resolution in the Y-axis direction).

Available setting values: [STD., FINE, FAST]

Press the [FUNCTION] key while the quality item is selected. Then the printer permits setting the number of passes for every resolution and setting high-speed printing ON/OFF.

The table below shows the combinations of the elements that can be set.

Resolution in DRAFT mode	4 colors		6 colors		DRAFT quality
	Passes	High-speed printing	Passes	High-speed printing	
540x720 dpi	4	ON / OFF	8	ON / OFF	FAST
	8	ON / OFF	16	ON / OFF	STD.
	16	ON / OFF	32	ON / OFF	FINE
540x900 dpi	10	ON / OFF	10	ON / OFF	FAST
	20	ON / OFF	20	ON / OFF	STD.
	40	ON / OFF	40	ON / OFF	FINE
540x1080 dpi	6	ON / OFF	12	ON / OFF	FAST
	12	ON / OFF	24	ON / OFF	STD.
	24	ON / OFF	48	ON / OFF	FINE

Table 6-1 : Element that can be set in DRAFT quality mode

FINE quality

Set a desired print quality in FINE mode (720 dpi resolution in the Y-axis direction).

Available setting values: [STD., FINE, FAST]

Press the [FUNCTION] key while the quality item is selected. Then the printer permits setting the number of passes for every resolution and setting high-speed printing ON/OFF.

The table below shows the combinations of the elements that can be set.

Resolution in FINE mode	4 colors		6 colors		FINE quality
	Passes	High-speed printing	Passes	High-speed printing	
540x720 dpi	6	ON / OFF	6	ON / OFF	FAST
	12	ON / OFF	12	ON / OFF	STD.
	24	ON / OFF	24	ON / OFF	FINE
720x720 dpi	4	ON / OFF	8	ON / OFF	FAST
	8	ON / OFF	16	ON / OFF	STD.
	16	ON / OFF	32	ON / OFF	FINE
720x1080 dpi	6	ON / OFF	12	ON / OFF	FAST
	12	ON / OFF	24	ON / OFF	STD.
	24	ON / OFF	48	ON / OFF	FINE
720x1440 dpi	8	ON / OFF	16	ON / OFF	FAST
	16	ON / OFF	32	ON / OFF	STD.
	32	ON / OFF	64	ON / OFF	FINE

Table 6-2 : Element that can be set in FINE quality mode

The print quality in Super fine mode (1440x1440) is fixed.

SCAN DIRECTION

Set the printing direction.

Available setting values: [Bi-D, Uni-D]

LOGICAL SEEK

Set LOGICALseek ON / OFF.

Available setting values: [ON, OFF]

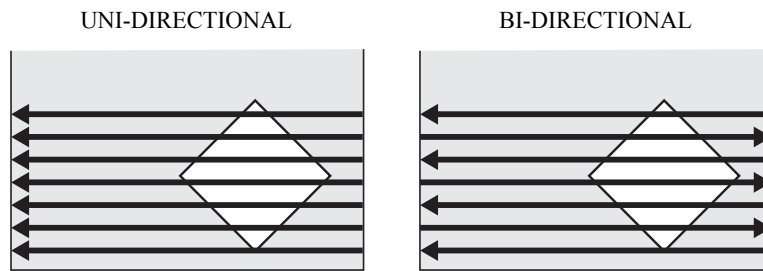

Movement of heads when LOGICALseek is OFF

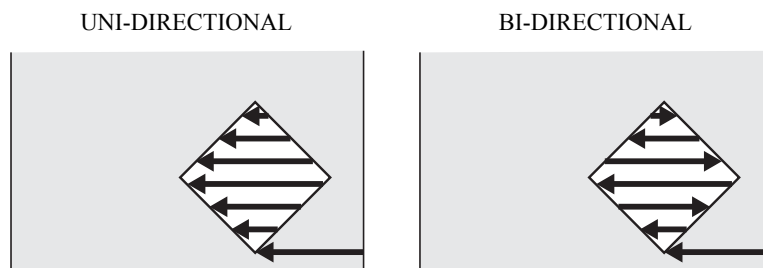

Movement of heads when LOGICALseek is ON

INK LAYERS

Set the number of layers in which ink is applied.

Available setting values: [1 to 9 layers]

The setting values for each user type are stored separately from those for other user types.

DRYING TIME

Set the time to wait for ink drying.

SCAN

Set the time to wait for ink drying after each pass. During bidirectional printing, the printer stops temporarily after every outward trip and every homeward trip.

Available setting values: [0.0 ~ 19.9 sec] (in steps of 0.1 sec)

Draw.END

Set the time to wait for ink drying after completion of printing.

Available setting values: [0 ~ 999 sec] (in steps of 1 sec)

The setting values for each user type are stored separately from those for other user types.

PRE-FEED

Set whether or not to feed the media back and forth before printing to prevent the media from sticking to the platen.

Available setting values: [ON, OFF]

The setting values for each user type are stored separately from those for other user types.

MARGIN

Set a non-printing area along the right and left edges of the media

Left margin

Set the width of the non-printing area along the left edge of the media.

Available setting values: [-20 ~ 75 mm] (In steps of 1 mm)

Right margin

Set the width of the non-printing area along the right edge of the media.

Available setting values: [-20 ~ 75 mm] (In steps of 1 mm)

The setting values for each user type are stored separately from those for other user types.

COLOR PATTERN

Sets whether you draw the nozzle missing check pattern on both edges of the media respectively.

Available setting values for right edge: [ON, OFF]

When the pattern is to be printed, the printing location of image data is shifted by 18 mm from the origin in the scanning direction.

The setting values for each user type are stored separately from those for other user types.

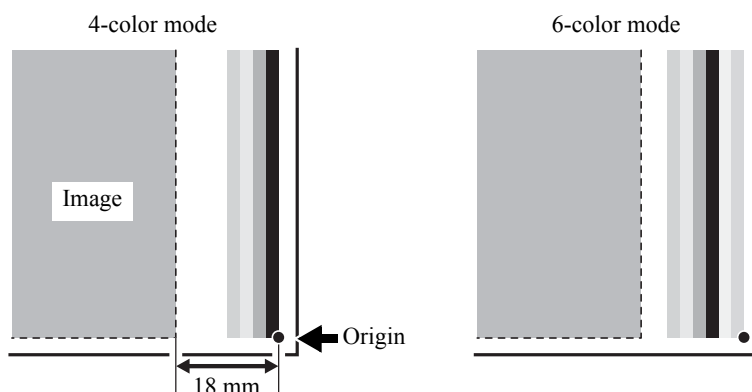

Check pattern

Available setting values for left edge: [OFF, ONx1 to ONx5]

The pattern can be printed with ONx1 to ONx5 and can be changed the width of the pattern.

The setting values for each user type are stored separately from those for other user types.

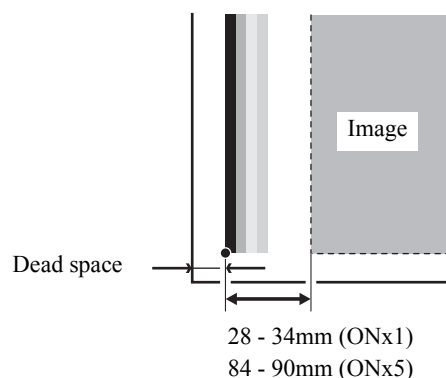

Check pattern

REFRESH

Set the head refreshing level (running flush interval).

Available setting values: [0 ~ 3] (Enhancing the level shortens the interval)

The setting values for each user type are stored separately from those for other user types.

DRYNESS FAN

Sets the strength of the rear surface dryness fan.

Available setting values: [STRONG, STANDARD, Little WEAK, WEAK, OFF]

The setting values for each user type are stored separately from those for other user types.

PRIORITY

Concerning the following setup functions, select whether priority is given to the settings made on the printer or to the designation from the host.

[MEDIA COMP.] , [HEATER] , [PRINT MODE] , [INK LAYERS] , [DRYING TIME] , [PRE-FEED] , [MARGIN] , [COLOR PATTERN] , [REFRESH] , [FD.SPEED]

Available setting values: [INDIVIDUALLY, ALL HOST, ALL PANEL]

The setting values for each user type are stored separately from those for other user types.

INDIVIDUALLY	For each function, set whether priority is given to the printer or to the host independently.
ALL HOST	For all the functions, priority is given to the settings on the host.
ALL PANEL	For all the functions, priority is given to the settings on the printer.

Even when setting has been made to give priority to the host, the settings made on the printer become effective if there is no instruction from the host.

AUTO CLEANING

(Refer to the Chapter 3 “Automatic cleaning” of the JV5-320S Operation Manual.)

Set whether or not to clean the heads automatically before printing.

Available setting values: [ON, OFF]

The cleaning will be performed prior to the first printing after the printer is put on. Subsequently, the cleaning is made for each meter of drawing prior to each drawing.

The detail setting menu is displayed by pressing the [FUNCTION] key during automatic cleaning ON/OFF selection.

CLEANING INTERVAL

Set the interval at which cleaning is to be performed periodically during printing.

Available setting values: [10 ~ 30000 mm] (Default: 1000 mm)

CLEANING TYPE

Set a type of automatic cleaning.

Available setting values: [SOFT, NORMAL, HARD]

The setting values for each user type are stored separately from those for other user types.

Maintenance while printing

(Refer to the Chapter 3 "Maintenance while Printing" of the JV5-320S Operation Manual.)

While printing, set whether to perform automatic cleaning or wiping the heads.

Available setting values: [CLEANING , WIPING , OFF]

Cleaning will be performed at a movement interval as a unit after starting each drawing.

When cleaning is selected, the details setting menu is obtained with [FUNCTION] key.

Wiping will be performed at each scanning times as a unit after starting each drawing.

When wiping is selected, the details setting menu is obtained with [FUNCTION] key.

The setting values for each user type are stored separately from those for other user types.

HEAD GAP (See P.3-2)

Set the head gap (height from the media to the nozzle plane of the heads).

Available setting values: [1.5 mm ~ 5.0 mm] (In steps of 0.1 mm / Default: 1.5 mm)

The upper limit of the head gap varies with media thickness.

The setting values for each user type are stored separately from those for other user types.

MEDIA DETECT

Sets the media detection method.

Available setting values : [AUTO, MANUAL] (Default: AUTO)

When AUTO is selected

After entering the thickness of the media when starting media detection, the media width will be detected automatically.

When MANUAL is selected

After entering the thickness of the media when starting media detection, enter the media width manually and set the media edge surface position.

If you use media that cannot be detected automatically, use this function.

SETUP RESET

Reset the settings of the setup functions assigned to the user types 1 to 4 to the default values.

Invoking MAINTENANCE functions

The maintenance functions described here are to be executed to keep the printer in good condition. To carry out maintenance of the printer, select [MAINTENANCE] from the FUNCTION menu and make the necessary settings.

The maintenance of the station can be performed independently by pressing the [ST.MAINT] key.

List of functions

This section describes briefly the maintenance functions and their setting values.

Name	Function	Page in this manual
ST.MAINTENANCE	Clean the inside of the station and ink discharge passage and replace the wiper. (CARRIAGE OUT, WIPER EXCHANGE, NOZZLE WASH, DISWAY WASH, CUSTODY WASH, PUMP TUBE WASH, WIPER WASH, Sub-INK MAINTENANCE)	P.2-13
CR.MAINTENANCE	Move the head unit to the left end of the printer and perform maintenance of the heads and their surrounding parts.	P.2-13
HD.MAINTENANCE	Perform various maintenance operations of the heads. (FILL UP INK, DISCHARGE&WASH, MaintWashLiquid)	P.2-14
FLUSHING BOX	To be performed to let the equipment realize the execution of cleaning after the cleaning of the flushing box.	P.2-14
DROP.POScorrect	Once the head height or ink type is changed, correct the dot position.	P.2-14
PG DROP ADJUST.	Set the reference value for correcting the misalignment of the ink fall points between outward trip and homeward trip in bi-directional printing when the head height has been changed. This function must be executed whenever the ink type has been changed or initial charge with ink has been performed.	P.2-14
SLEEP SET UP	Perform head cleaning and flushing operation to prevent nozzle clogging. (REFRESH, TUBE WASH, CLEANING)	P.2-15
ROUTINE SETUP	Set the functions to be executed periodically while the printer is in stand-by mode. (REFRESH, TUBE WASH, CLEANING, Sub-INK WARNING)	P.2-15
WIPER LEVEL	Make setting so that the printer gives the wiper replacement warning earlier than standard depending on the operating environment.	P.2-15
HEAD SELECT	Select the head(s) to be used for printing.	P.2-15
MEDIA RESIDUAL	Make setting of the media remaining amount display function.	P.6-13
BeforeMovingIt.	Use this function to lock the station when the printer is to be transported.	P.6-14

Setting a maintenance function

Take the following steps on the operation panel to execute a maintenance function.

STEPS:

- 1 Make sure that the printer is in LOCAL mode, and then select [MAINTENANCE] using the [FUNCTION] key and press the [ENTER] key.**

If it is in REMOTE mode, press the [REMOTE] key once.



- 2 Select a maintenance function and make setting.**

Operation procedure with the [ST.MAINT] key (ST.MAINTENANCE)

- 1 Make sure that the printer is in LOCAL mode.**

If it is in REMOTE mode, press the [REMOTE] key once.

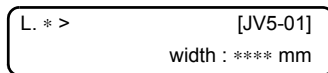

- 2 Press the [ST.MAINT] key.**

As [ST.MAINTENANCE] is displayed, perform each maintenance operation.

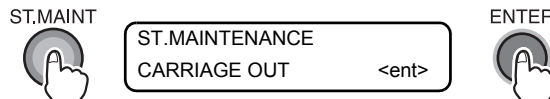

Make setting of the media remaining amount display function

[MEDIA RESIDUAL]

Set ON/OFF of the media remaining amount display function. (Normally OFF)

With the media remaining amount display function set to ON, the media remaining amount is displayed in REMOTE mode.

The media feed during printing or with any of the JOG keys is reflected on media remaining amount. Input the media length (initial value of remaining amount) when the roll media is detected.

When no media length is input, the print length is displayed.

STEPS:

- 1 Make sure that the printer is in LOCAL mode, and then select [MAINTENANCE] using the [FUNCTION] key and press the [ENTER] key.**

If it is in REMOTE mode, press the [REMOTE] key once.



- 2 Select [MEDIA RESIDUAL] by pressing the [▼] key 10 times and press the [ENTER] key.**



- 3 Set the setting of remaining amount to ON or OFF by pressing the [▲] or [▼] key.**

Register the setting by pressing the [ENTER] key.

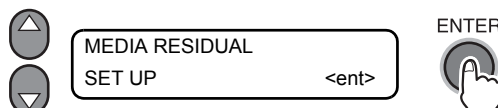

- 4 Press the [END] key several times.**

The printer returns to LOCAL mode.

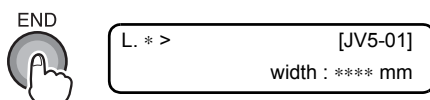

Moving the printer safely [BeforeMovingIt.]

Use this function to lock the station when the printer is to be moved.

Use this function when the printer is to be moved in such a way that some vibration is expected.

However, when the printer is to be moved, be sure to contact your dealer or an office of MIMAKI.

STEPS:

- 1 Make sure that the printer is in LOCAL mode, and then select [MAINTENANCE] using the [FUNCTION] key and press the [ENTER] key.**

If it is in REMOTE mode, press the [REMOTE] key once.



- 2 Select [BeforeMovingIt.] by pressing the [▼] key 11 times and press the [ENTER] key.**



- 3 Make preparation for moving the printer.**

When preparation has been made, press the [ENTER] key.



- 4 Press the power button in the front.**

The lamp on the power switch is put off.

- 5 Turn the main power supply OFF, unplug the power cable, and move the printer.**

When moving the printer, it must be held up by several people as illustrated below.

The cover of the printer may break if it is pressed hard.

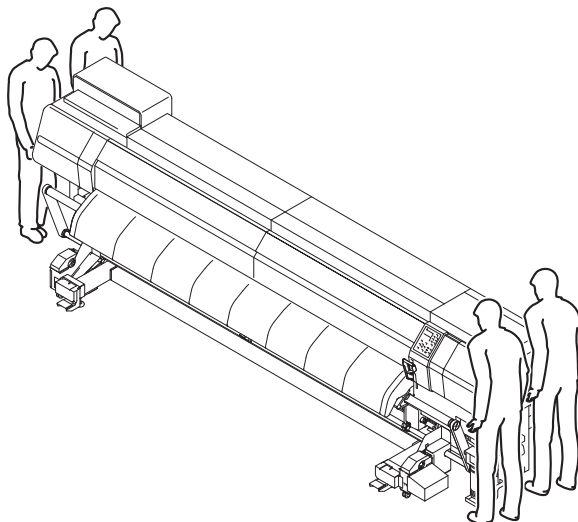

Invoking MACHINE SETUP functions

List of functions

This section describes briefly the machine setup functions and their setting values.

Name	Function	Page in this manual
REAR MIST FAN	Set the mist fan in the rear of the machine.	P.6-17
Feeding/TakeUP	For heavy-duty feeding / take-up device, set whether to use or not to use. In addition, sets the position of the tension bar (LOW/HIGH).	P.6-17
DRYNESS FEED	Change the feed operation after printing.	P.6-18
CONFIRM. FEED	Set whether or not to perform feeding the media after test printing for checking of the printing result.	P.6-18
PRE-FEED METHOD	Switch the pre-feed operation method.	P.6-18
HEATER SETUP	Change the temperature range of the post-heater that determines whether the temperature is reached.	P.6-18
TIME SET	Set the date and time on the printer.	P.6-18
UNIT SETUP	Change the units of temperature, length and area to be used with the printer.	P.6-19
STAMP SETUP	Make settings for outputting the date and time and printing conditions after printing.	P.6-19
CART. PRIORITY	You can select the cartridge status to use first with the double cartridge function of ink supply.	P.6-20
Test Draw Arrange	You can set the placement direction of the drawn test pattern when performing test drawing repeatedly.	P.6-20
MACHINE NAME	When the printer is connected through the USB 2.0 interface to a system to which two or more machines are connected, set the identifier of the printer to have the system recognize it.	P.6-20
ENV. TEMP.	Set the operation when drawing was tried to start with the temperature of the place where this machine has been installed being outside the range of usable temperature.	P.6-20
INFORMATION	Displays various information. In Local Mode, it can also display by pressing the [INFORMATION] key.	P.6-21

Functions of [INFORMATION] key

This section describes briefly the [INFORMATION] functions and their setting values.

Name	Function	Page in this manual
ERROR HISTORY	Displays the history of errors.	P.6-21
MAINTE. HISTORY	Displays the records of the date and time when maintenance functions were used.	P.6-21
PRT.modeHISTORY	Displays the history of information (printing conditions) of the online printing that has been performed up to now.	P.6-21
LIST	Prints the data for the operator to check the settings of the printer.	P.6-21
Ink REPL. Report	Draws ink cartridge replacement information.	P.6-21
VERSION	Displays various version information of the equipment.	P.6-22
Serial&DealerNo	Displays serial No. and dealer No. of the printer.	P.6-22

Setting a MACHINE SETUP

The operation described below on the operation panel is required to execute machine setup functions.

STEPS:

- 1 Make sure that the printer is in LOCAL mode, and then select [MACHINE SETUP] using the [FUNCTION] key and press the [ENTER] key.**

If it is in REMOTE mode, press the [REMOTE] key once.



- 2 Select a machine setting function and make setting.**

Outline of the machine setup functions

REAR MIST FAN

Sets the operation of the rear mist fan.

STOP TIMER

Sets time from drawing has completed to the fan stops.

Available setting values : [CONTINUE, 0 ~ 240min] (Default: 120min [unit 10min.])

If this is set to [CONTINUE], the fan will always operate.

RENEW

Switches the fan operation. (Depending on the setting, operates the fan motor.)

Available setting values : [ON , OFF]

Setting contents will not be saved.

Rear mist fan operates during drawing and from drawing has completed, it operates depending on the setting of the stop timer.

Feeding / TakeUP

UNIT SELECT

For heavy-duty feeding / take-up device, set whether to use or not to use.

Available setting values: [ON, OFF]

After switching ON to OFF, move the tension-bar of each device to the lock position.

Especially for heavy-duty take-up device, you cannot switch the setting unless moving the bar to the lock position.

Tension Bar-POS.

Switches the setting of the tension bar position.

Available setting values : [LOW , HIGH] (Default: LOW)

DRYNESS FEED

Set whether or not to perform feeding for media drying.

Available setting values: [ON, OFF]

With DRYNESS FEED set to ON, the printer feeds the media up to the location of the post-heater where the media is dried.

After waiting for a period of time that has been set by the setup Function (DRYING TIME - DRAWend), the printer performs the next printing (media cutting). No back feed is performed. (Printing will be started at the position to which the media has been fed for media drying.)

CONFIRM. FEED

Set whether or not to perform feeding the media after test printing for checking of the printing result.

Available setting values: [ON, OFF]

With CONFIRM. FEED set to ON, the media after completion of printing will be fed up to a position where the print result can be checked on the platen.

In addition, when CONFIRM. FEED has been set to ON, [BACK FEED] can be set to ON using the [FUNCTION] key.

The [BACK FEED] function returns to the original position the media that has been fed by the [CONFIRM. FEED] function.

Available setting values: [ON, OFF]

PRE-FEED METHOD

Switch the operation method of pre-feeding.

Available setting values: [FORE (**mm), FORE&BACK]

When FORE (**mm) is set, a media is pre-fed at specified amount, to remove the media that has waved by the heat of the heater.

Change the feeding length of the media with [FUNCTION] key when FORE is selected.

Available setting values: [10 to 1000mm]

When FORE&BACK is set, a media is pre-fed back and forth at specific amount, to avoid media sticking.

HEATER SETUP

Set the temperature that determines whether the post-heater is reached to the specified temperature.

Available setting values: [STD, set -5°C, set -10°C, set -15°C, set -20°C]

When STD is set, this machine assumes the post-heater temperature has been reached when it reaches to the specified temperature.

When Set -5°C, Set -10°C, Set -15°C, or Set -20°C is set, this machine assumes the post-heater temperature has been reached when the temperature is more than the set one subtracted the selected one.

Post-heater temperature easily lowers after printing.

In case of printing some data continuously with STD is set, if the temperature does not reach between completion of one data printing and a start of next printing, it displays "Temperature controlling." It does not start printing until the temperature reaches.

If you want to print continuously at low temperature, select other than STD.

TIME SET

Set the date and time on the printer.

A past date and time up to 8 o'clock can be input.

If you have set a time in the future by mistake, the setting value can be returned to the previous setting value by pressing the [FUNCTION] key. However, it is only the last previous setting value that the setting made by mistake can be returned to.

The actually indicated last previous setting time is the last previous setting value plus the actually elapsed time.

UNIT SETUP

Set the units of measure to be used with the printer.

Temperature

Set the unit of temperature.

Available setting values: [°C (Centigrade) , °F (Fahrenheit)]

Length

Select the unit system for the units of length and area.

Available setting values: [mm , inch]

Unit system	Units		
Millimetre	mm	m	m ²
Inch	inch , mil	ft	ft ²

STAMP SETUP

Set whether or not to output the printing conditions and the date and time of printing.

With STAMP SETUP set to ON, the printer prints the conditions and the date and time after completion of printing one file.

Available setting values: [ON , OFF]

With STAMP SETUP set to ON, the printer outputs the following particulars after printing on each page.

- Machine name
- F / W Version
- Resolution
- Number of divisions
- Printing direction
- Scanning speed
- Number of layers
- Media feed correction value
- Head gap
- Ink type & number of colors
- Heater setting temperatures PRE / POST
- Date and time of printing

```

JV5-320DS   Ver6.00
PRINT MODE  : 720x720 8PASS Uni-D Hi      1LAYER
MEDIA COMP. : 0(0,0)
HEAD GAP    : 1.5mm
INK         : Sb52-4color
HEATER TEMP.: PRE :40°C  POST:50°C
DATE        : 09.10.08 15:27:12
    
```

CART. PRIORITY

You can select the cartridge status to use first with the double cartridge function of ink supply.
Available setting values : [INK LEVEL, EXP. DATA] (Default: INK LEVEL)

When INK LEVEL is selected

First use the cartridge of less remaining amount of ink.

When EXP. DATA is selected

First use the cartridge whose expiration date is coming sooner.

Test Draw Arrange

You can set the placement direction of the drawn test pattern when performing test drawing repeatedly.
Available setting values : [FEED DIR., SCAN DIR] (Default: FEED DIR.)

When FEED DIR. is selected

When test pattern is drawn repeatedly, place the test pattern in the FEED direction.

When SCAN DIR. is selected

When test pattern is drawn repeatedly, place the test pattern in the SCAN direction.

MACHINE NAME

When the printer is connected through the USB 2.0 interface to a system to which two or more machines are connected, set the identifier of the printer to have the system recognize it.
As a machine name, enter only the printer number in the form [JV5 - ** (printer number)].
Available setting values: [01 ~ 99] (Default: 01)

Ambient temperature

Set the operation when drawing was tried to start with the temperature (ambient temperature) of the place where this machine has been installed being outside the range of usable temperature.
Setting value: [Not wait ARR., Wait arrival] (Default: Not wait ARR.)

When selecting [Not wait ARR.]

Only displays the error and continues drawing.

When selecting [Wait arrival]

Displays the error, waits until the ambient temperature becomes within the usable range and then starts drawing.

INFORMATION

INFORMATION, one of the MACHINE SETUP functions, consists of menus for checking the information of the printer.

This function can be activated directly by pressing the [INFORMATION] key.

Item	Description
ERROR HISTORY	Displays the history of errors and warnings.
MAINTE. HISTORY	Displays the history of the use of maintenance functions
PRT.modeHISTORY	Displays printing history.
LIST	Prints the printer setting information.
Ink REPL. Report	Draws ink replacement history.
VERSION	Displays the equipment versions.
Serial&DealerNo	Displays serial No. and dealer No. of the printer.

ERROR HISTORY

History of errors and warnings that have occurred up to now are displayed. (ONLY ERROR, ONLY WARNING, ALL)

Using the [▲] or [▼] key, the errors and warnings can be displayed one by one in the order of occurrence.

Display: Date and time (YY, MM, DD, hh, mm) of occurrence, Description of error or warning

MAINTE. HISTORY

Displays the records of the date and time when maintenance functions were used.

The display relates chiefly to manual cleaning functions or automatic cleaning functions (by SLEEP SETUP or ROUTINE SETUP).

One LCD shows the record of one maintenance operation.

PRT.modeHISTORY

Displays the information (printing conditions) of the online printing that has been performed up to now since power-on. (Max. 50)

Using [▲] or [▼] key, the display can be changed in the order of printing.

Display: Date, history number, resolution, number of passes, printing direction, data format (Variable / Normal), scanning speed, number of layers, print length (at completion of printing)

LIST

Prints the settings of the printer.

The output format is as shown below. (The format, however, varies with the settings of [DISPLAY] and [UNIT SETUP].)

Ink replacement report

Draws ink cartridge replacement history.

You can select ink color without nozzle clogging.

VERSION

Displays version information of the equipment.

Item	Display	Remarks
Model	JV5-320DS	
Main F / W Version	* . **	
NCU F / W Version	* . **	
I / F type	USB I / F	USB 2.0
I / F F / W Version	* . **	
MRL-III command Version	* . **	

Serial&DealerNo

Displays the serial No. and dealer No. of the printer.

Invoking NCU functions

This function is available only when the machine is equipped with the optional nozzle check unit (OPT-J0218).

List of functions

This section describes briefly the NCU functions and their setting values.

Name	Function	Page in this manual
NOZZLE CHECK	Set whether or not to perform nozzle missing detection.	P.6-24
NG ACTION (*1)	Set the operation of the printer to be performed in case the preset number of or more missing nozzles are detected and thus NG judgment is made. (*2)	P.6-24
NG JUDGEMENT (*1)	Set the number of missing nozzles for NG judgment. (*2)	P.6-25
COND.INDICATION	Displays the status of the NCU.	P.6-25



■NG (*1): Bad nozzle condition.

■NG (*2): One or more bad nozzles have been located on print head.

Setting a NCU functions

The operation described below on the operation panel is required to execute NCU functions.

STEPS:

- 1** Make sure that the printer is in LOCAL mode, and then select [NCU] using the [FUNCTION] key and press the [ENTER] key.

If it is in REMOTE mode, press the [REMOTE] key once.



- 2** Select an NCU function and make setting.

Outline of the NCU functions

The NCU functions consist of operations concerning the nozzle missing detection function.

Setting

Make settings of the function that monitors nozzle missing with the nozzle check unit.

Nozzle check

Set whether or not to perform nozzle missing detection.

Available setting values: [ON, OFF] (Default: ON)

NG ACTION (*1)

NG ACTION [DURING THE DRAW] (*1)

Set the operation of the printer during printing in case a preset number of missing nozzles or more are detected and thus NG judgment is made. (*2)



■ **NG (*1): Bad nozzle condition.**

■ **NG (*2): One or more bad nozzles have been located on print head.**

CONTINUE	The printer keeps on printing. (Default)
CLEANING&CONT	Corrects clogged nozzles by cleaning. Whether the printer succeeds or fails in cleaning, it restarts printing.
CLEANING&STOP	Corrects clogged nozzles by cleaning. If the printer fails in cleaning, it does not restart printing.
STOP	Stops printing.

The detail setting menu for cleaning is displayed by pressing the [FUNCTION] key with [CLEANING&CONT] or [CLEANING&STOP] selected.

■ **CLEANING TYPE [CLEANING&CONT], [CLEANING&STOP]**

Set a type of cleaning.

Available setting values: [NORMAL, SOFT, HARD] (Default: NORMAL)

■ **RETRY COUNT [CLEANING&STOP]**

Set the number of times cleaning is to be retried.

Available setting values: [0 ~ 3] (Default: 3)

With RETRY COUNT set to 3, the printer will perform cleaning operation a maximum of four times (as long as clogged nozzles are not corrected) including the first cleaning operation.

NG ACTION [AFTERtheDRAWend] (*1)

Set the operation of the printer after completion of printing of one file in case a preset number of missing nozzles or more are detected and thus NG judgment is made. (*2)

Important!

- **NG (*1): Bad nozzle condition.**
- **NG (*2): One or more bad nozzles have been located on print head.**

CONTINUE	The printer keeps on printing. (Default)
CLEANING&CONT	Corrects clogged nozzles by cleaning. Whether the printer succeeds or fails in cleaning, it restarts printing.
CLEANING&STOP	Corrects clogged nozzles by cleaning. If the printer fails in cleaning, it does not restart printing.
STOP	Stops printing.

The detail setting menu for cleaning is displayed by pressing the [FUNCTION] key with [CLEANING&CONT] or [CLEANING&STOP] selected.

- **CLEANING TYPE [CLEANING&CONT], [CLEANING&STOP]**
Set a type of cleaning.
Available setting values: [NORMAL, SOFT, HARD] (Default: NORMAL)
- **RETRY COUNT [CLEANING&STOP]**
Set the number of times cleaning is to be retried.
Available setting values: [0 ~ 3] (Default: 3)
With RETRY COUNT set to 3, the printer will perform cleaning operation a maximum of four times (as long as clogged nozzles are not corrected) including the first cleaning operation.
- Turn off the external heater when cleaning operation by **NG ACTION [DURING THE DRAW]** or **NG ACTION [AFTERtheDRAWend]** is to be performed. (*2)

NG JUDGEMENT (*1)

Set the number of missing nozzles for judging the nozzle check NG .(*2)

Important!

- **NG (*1): Bad nozzle condition.**
- **NG (*2): One or more bad nozzles have been located on print head.**

- **CLOGG NZL/color**
Set the number of missing nozzles per row for judging the nozzle check **NG** . (*2)
Available setting values: [1 ~ 180] (Default: 10)
- **CLOGG NZL/ALL**
Set the total number of missing nozzles for judging the nozzle check **NG** . (*2)
Available setting values: [1 ~ 180] (Default: 10)

COND.INDICATION

Displays the status of the NCU.

NCU works at present.	NCU is available.
NCU is separated due to the ERROR.	There is a problem with NCU. Operation can be resumed after turning off the nozzle missing detection function.

Pressing [FUNCTION] key, it displays every error that has occurred in the NCU and between NCU ↔ Main Unit. Using the [▲] or [▼] key, the errors can be displayed one by one in the order of occurrence.

Contents

Chapter 1

Chapter 2

Chapter 3

Chapter 4

Chapter 5

Chapter 6

DISPLAY setting

Set a language to be used with the printer.

Language

- Japanese
- English
- German
- French
- Spanish
- Italian
- Portuguese

The setting is reflected on the indications on the LCDs.

Applied settings of functions

Initial settings can be changed, as required.

Settings of heaters

Setting items for heaters

The items that can be set for the three heaters are as described below.

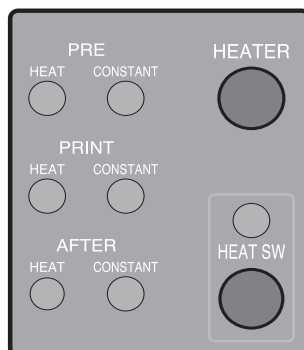

SET TEMP.

Set temperature for each of the two heaters.

PRE HEAT	Set the temperature of the pre-heater. (OFF, 20 ~ 60° C / 68 ~ 140° F)
POST HEAT	Set the temperature of the post-heater. (OFF, 20 ~ 70° C / 68 ~ 158° F)

SET TIME

Set the standby time and the time for turning OFF.

STANDBY	<p>Set the period of time from when printing is completed to when the heater temperature begins to drop to the preheat temperature. The preheat temperature is preset and cannot be changed.</p> <p>If the printer receives data at the preheat temperature, the heaters automatically raise their temperatures up to the preset levels and then the printer starts printing.</p> <p>When [NONE] is selected, the temperatures do not drop to the preheat level. (NONE, 0- 90 min / In steps of 10 minutes)</p>
OFF TIME	<p>The heaters are turned off in the following case:</p> <ul style="list-style-type: none"> ▪ If a preset time has passed without printing while the printer is in standby mode. ▪ With STANDBY-[NONE] selected, there may be a case where a preset time passes without printing after some printing and thus the heaters are turned off. If the printer receives data with the heaters turned off, the heaters are automatically turned on to raise their temperatures up to the preset levels and then the printer starts printing. <p>With [NONE] selected, the heaters are not turned off. (NONE, 0 - 90 min / In steps of 10 minutes)</p>

Detailed settings of heaters

Make settings of the pre-heater and post-heater built in the platen.

The temperatures of heaters can be adjusted even during printing so that optimum temperatures can be obtained.

However, it takes a heater a few minutes to more than ten minutes to reach the set temperature depending on the ambient temperature.



■ **Use this printer at 20-35° to ensure reliable printing. The heater temperatures may not rise to the set values depending on the ambient temperature.**

The temperature settings made here will be kept until the power is turned off or they are changed under any of the following conditions:

- Types are changed in FUNCTION mode.
- Heater temperatures are changed in FUNCTION mode.
- The heater temperatures are set on the computer.



■ **The heater temperatures can be controlled on your application software if it has a function to do so.**

For setting on the application software, refer to the instruction manual for your application software.

Setting value of temperature

°C	OFF, 20~60 (70) °C (In steps of 1 °C)
°F	OFF, 68~140 (158) °F (In steps of °F) * There may be some values that cannot be set in steps of 1 °F.

Rough guide for temperature setting

Heater	Fabric media	Paper media
Pre-heater	35°C	45°C
Post-heater	45°C	70°C



■ **Adjust each heater temperature to the best suited value to the media condition.**

Setting the temperatures and standby time of heaters

Set the temperatures and standby time of heaters by the following procedure:

STEPS:

1 Make sure that the printer is in LOCAL mode.

If it is in REMOTE mode, press the [REMOTE] key once.

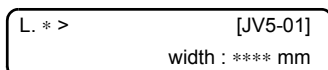

2 Select [SET UP] using the [FUNCTION] key and press the [ENTER] key. Select type 1 to 4 and press the [ENTER] key.



3 Select [HEATER] by pressing the [▼] key twice and press the [ENTER] key.

[SET TEMP.] is displayed.



4 Press the [ENTER] key to go to the lower level of hierarchy and input the setting values of heater temperatures using appropriate ones of the [▲], [▼], [◀] and [▶] keys.

Use the [▲] or [▼] key to change the setting values of temperatures, the [◀] or [▶] key to move the cursor, and the [ENTER] key to register the setting values in memory.

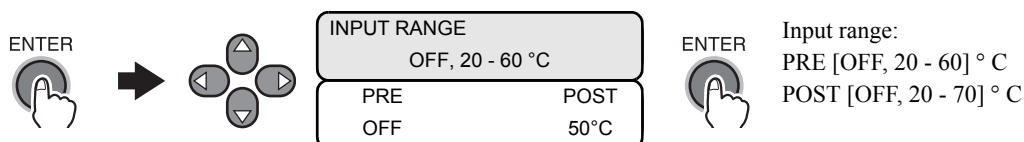

5 Press the [▼] key, select [SET TIME], and set [SET TIME].

Use the [▲] or [▼] key to change the setting value of the time, the [◀] or [▶] key to move the cursor, and the [ENTER] key to register the setting values in memory. (0 ~ 90 min (In steps of 10 minutes))

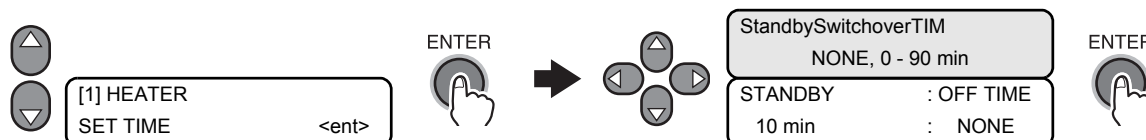

6 Press the [END] key several times.



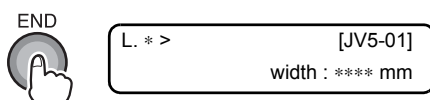









The printer returns to LOCAL mode.



How to operate function menus

The following pages show the operating procedures and the messages displayed on the LCDs, using the following icons.

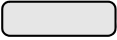
For detailed information of operation procedures, refer to the relevant pages.

Icon	Description
FUNCTION 	This icon means pressing the [FUNCTION] key once. This operation is used to enter [FUNCTION mode] or to go to the lower level of hierarchy.
	This icon means using appropriate ones of the [▲], [▼], [◀] and [▶] keys.
	This icon means pressing the [▲] or [▼] key to switch between the alternate sub setting displays or to change the setting value or item.
	This icon means pressing the [◀] or [▶] key to switch between setting values or items.
	This icon means pressing the [ENTER] key once to execute the setting value or item that is currently displayed.
ST.MAINT 	This kind of icon means pressing the indicated key once. (This icon means pressing the [ST.MAINT] key once.)
END 	This icon means pressing the [END] key to cancel the execution.
	This graphic represents the display.
	This graphic shows the behavior of the printer activated as a result of key operation.
	This graphic shows the set value of a menu item.
	This graphic shows the message displayed as a result of operation.
	This graphic shows the work other than the menu operations on the operation panel which you are required to do for the printer. This graphic is used together with the icon  .

Functions related to print quality

With function menus of the printer, the print quality can be checked and setting can be changed to improve the print quality.

Correcting media feed during printing [FEED COMPENSATION.]

With the [MEDIA FEED-COMPENSATION] function, as already described, operation is executed in LOCAL mode. However, the operation described here is to be executed to correct the media feed rate in REMOTE mode or during printing of image data.

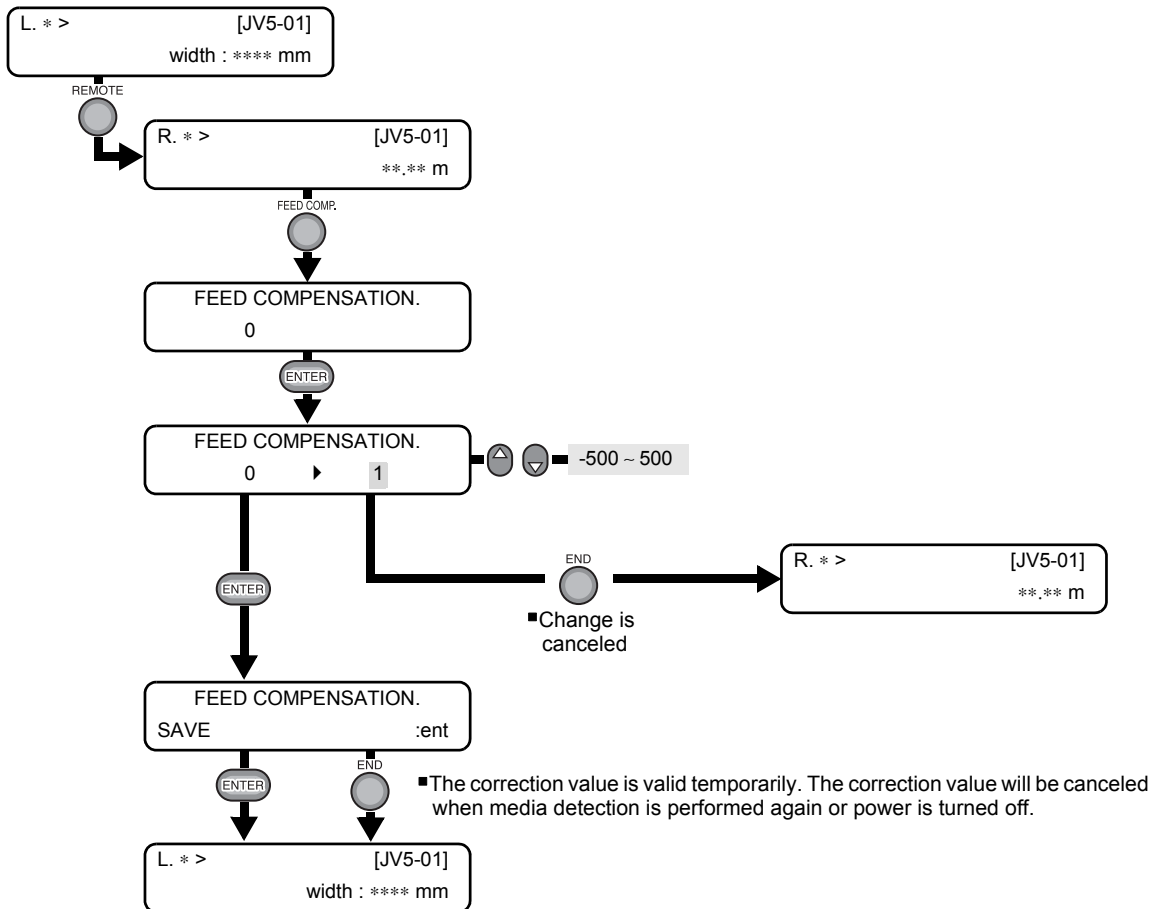

Functions related to ink

When ink sets (4-color, 6-color) are to be changed

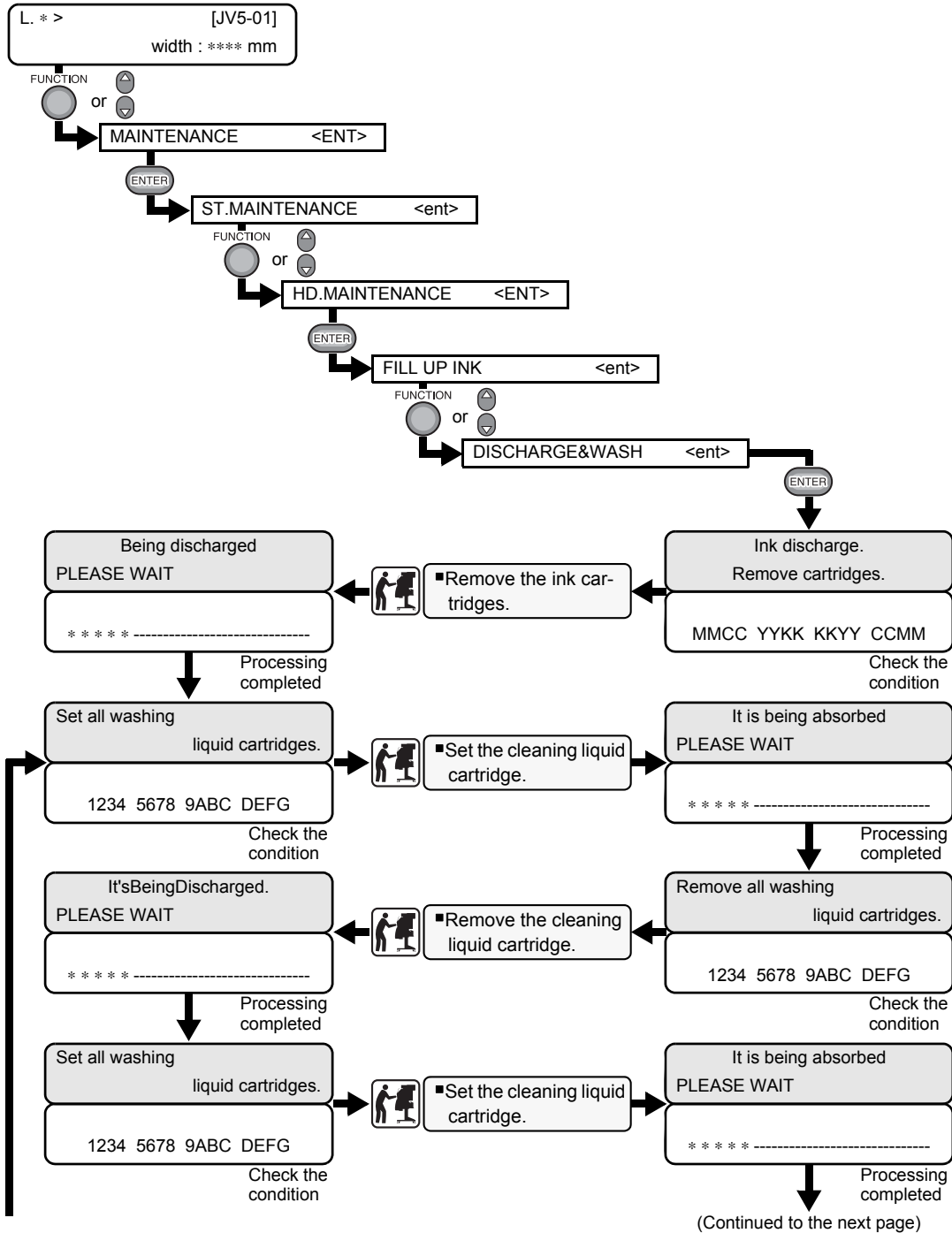

When ink sets (4-color and 6-color) are to be changed (continued)

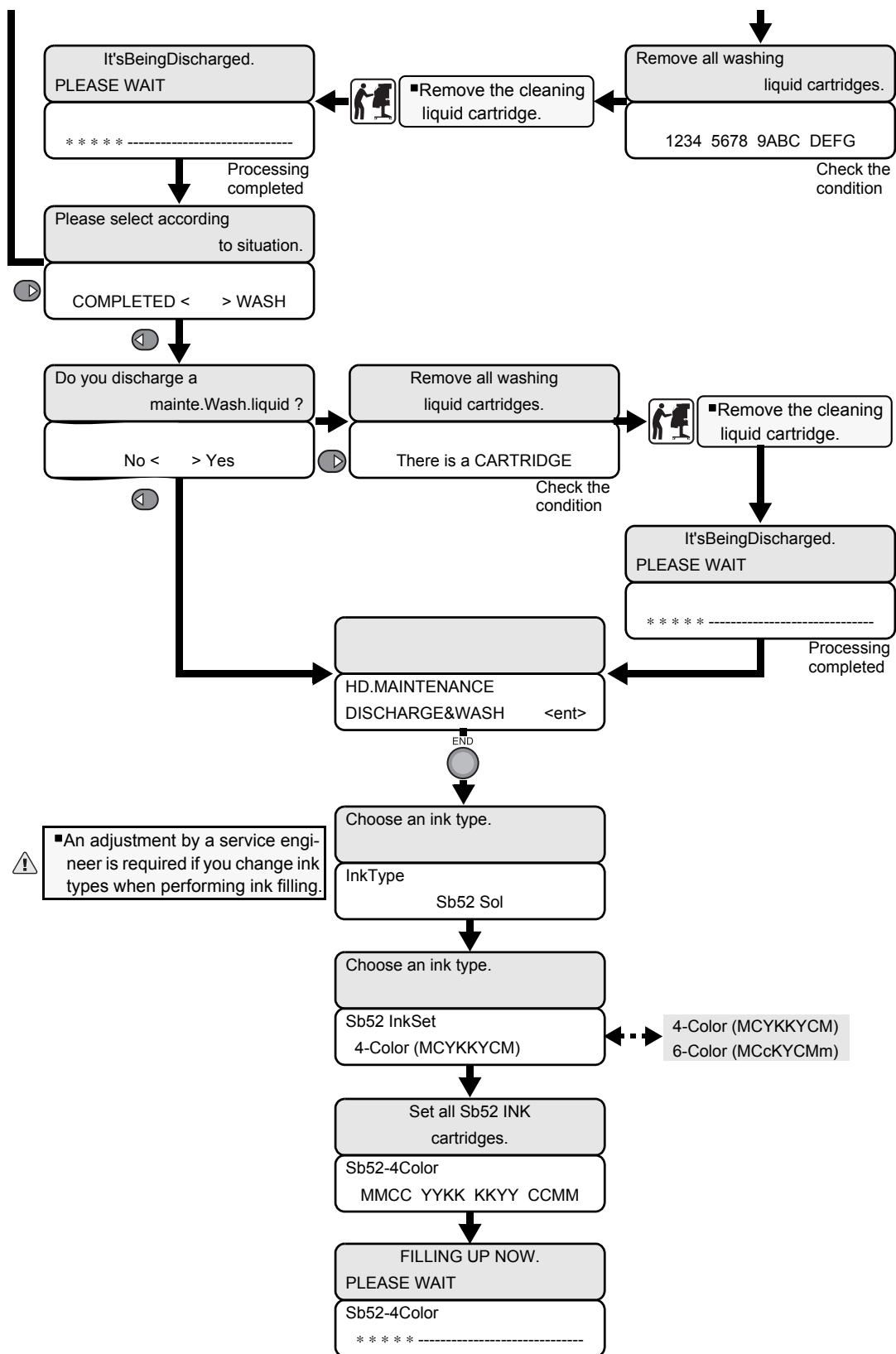

Function Flowchart [BOOT]

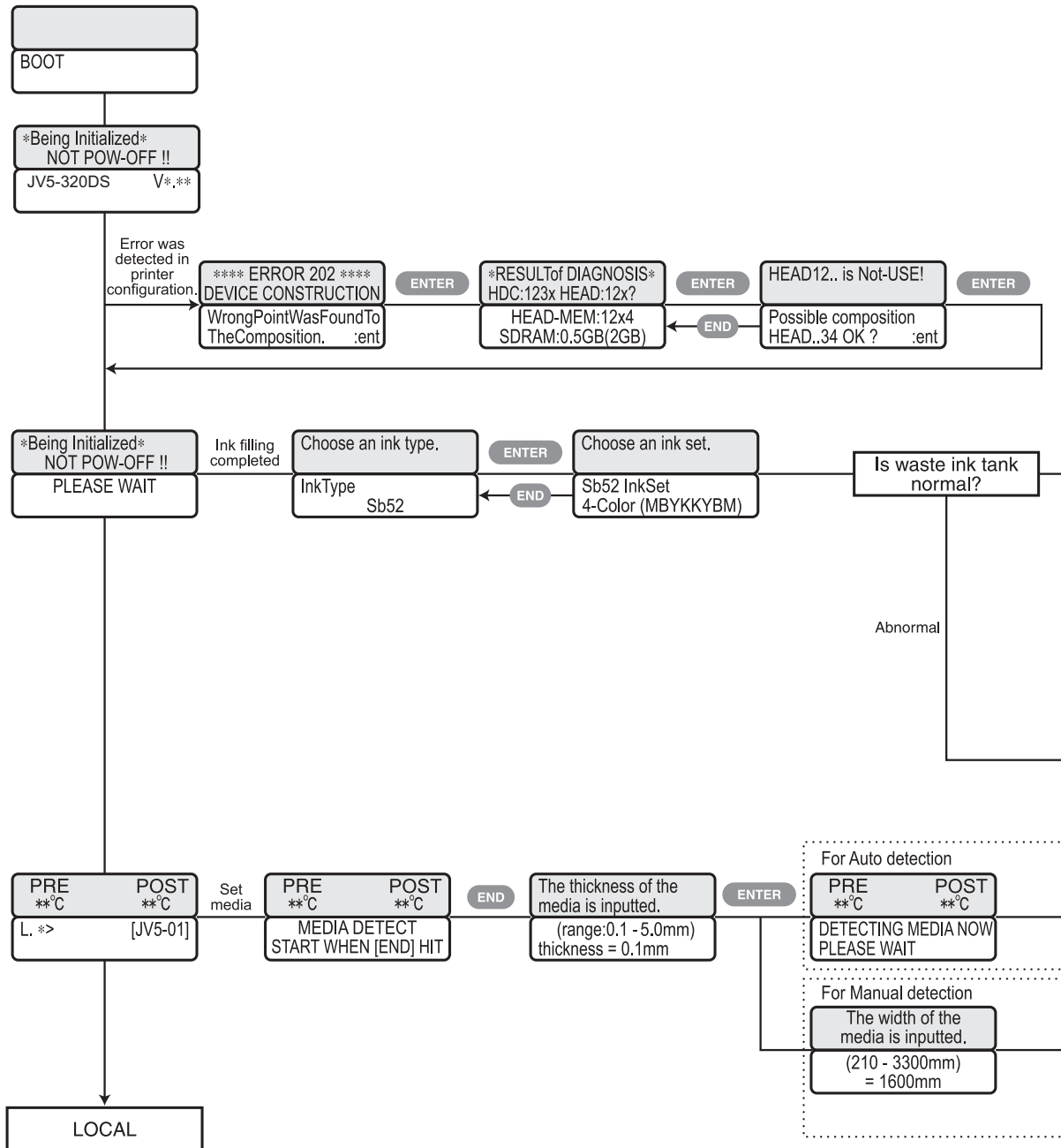

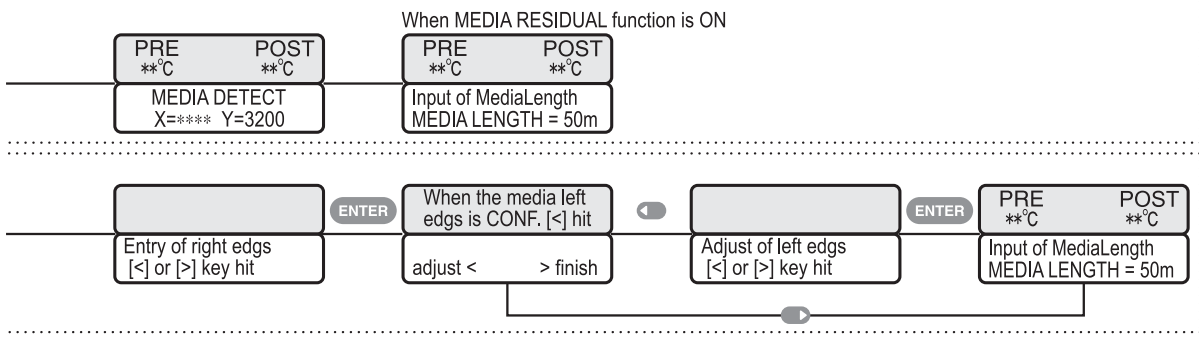
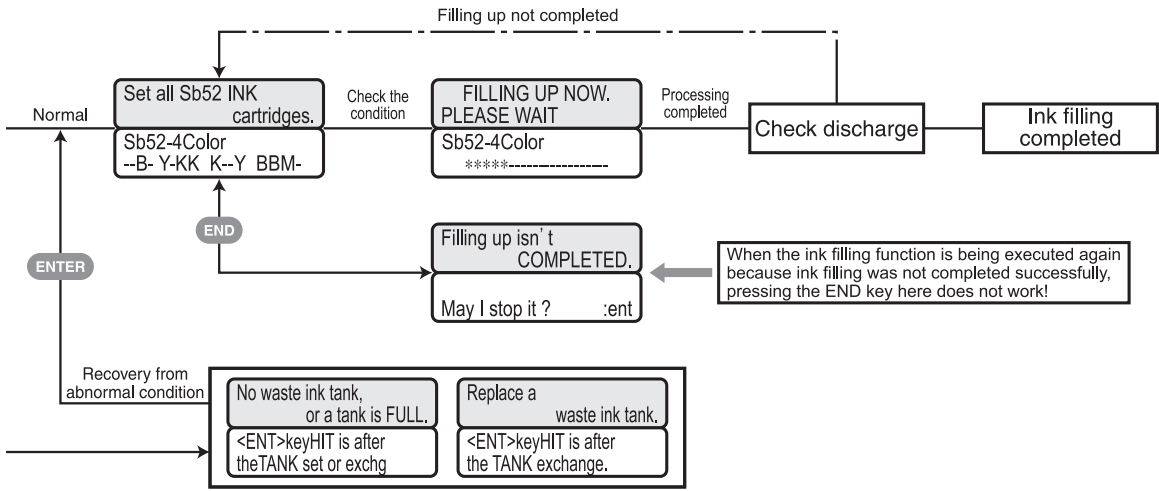

Contents

Chapter 1

Chapter 2

Chapter 3

Chapter 4

Chapter 5

Chapter 6

Function Flowchart [LOCAL mode]

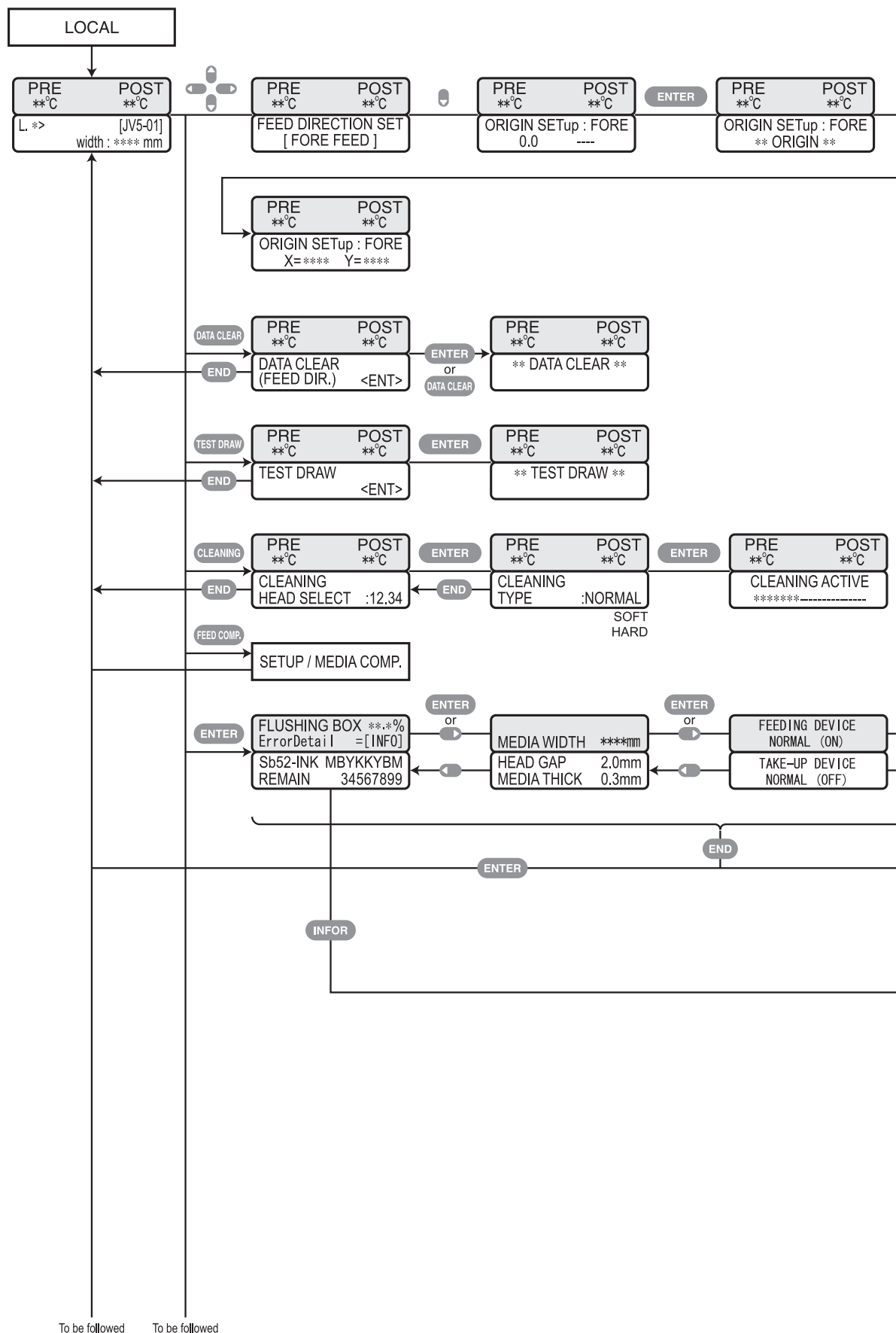

To be followed To be followed

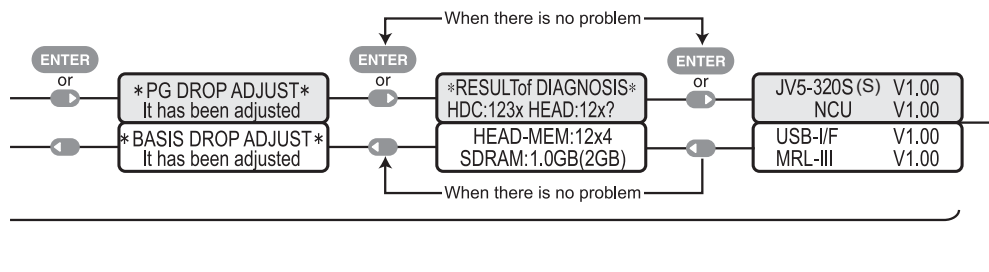

Set a Mimaki Original ink. NON-ORIGINAL INK M-B- --K --- B-M-	Extract a cartridge and set again. WRONG INK IC M-B- --K --- B-M-	Set a Sb52 INK Cartridge. Kind of INK M-B- --K --- B-M-	The color of ink is wrong. Color of INK M-B- --K --- B-M-	A cartridge is unusual. Please check WRONG CARTRIDGE M-B- --K --- B-M-	Set a cartridge. NO CARTRIDGE M-B- --K --- B-M-
It expires. Exchange it. Expiration: 2MONTH M-B- --K --- B-M-	There is no ink. Exchange it. INK REMAIN ZERO M-B- --K --- B-M-	Ink was finished. Exchange it. INK END M-B- --K --- B-M-	Ink will be finished soon. Exchange it. INK NEAR END M-B- --K --- B-M-	It expires. Exchange it. Expiration: 1MONTH M-B- --K --- B-M-	It expires. Exchange it. Expiration M-B- --K --- B-M-
Replace a waste ink tank. A waste ink tank is FULL soon now.	Replace a waste ink tank, or set it. A waste ink tank is FULL, or NONE.	Fill with the maint. washing liquid. Maint. washing liquid un-filling up.	Exchange a washing liquid cartridge. Maintenance washing liquid END.	Exchange a washing liquid cartridge. Maintenance washing liquid Near-END.	

Warning :Description of ink cartridge status is displayed. Two or more descriptions, if any, can be displayed in order using the [▲] or [▼] key.
Status change is displayed in real time.
The display will return to showing the remaining amount of ink by pressing [INFOR] or [END] key.

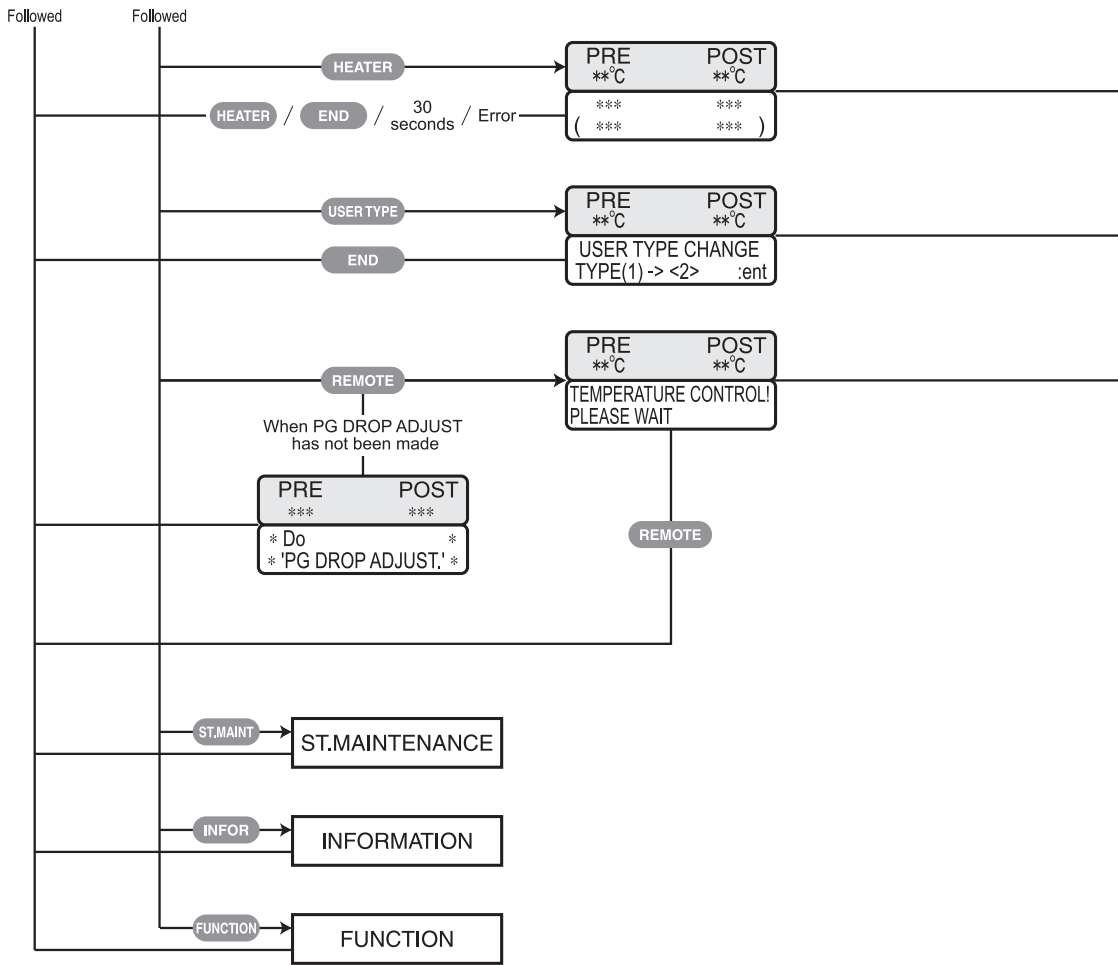

→ { Select the PRE, PRINT and POST one by one with [◀] or [▶] key.
 Adjust each temperature with [▲] or [▼] key.
 Range :OFF, 20 to 60 (PRE/PRINT)
 OFF, 20 to 70 (POST)

→ { The number in () represents the current type, which can be changed to the number shown in < >.
 The user type can be changed in the order of →2→3→4→... by pressing the [USER TYPE] key.
 It can also be changed using the [▲] or [▼] key.
 Press the [ENTER] key to confirm the selection or press the [END] key to cancel it.

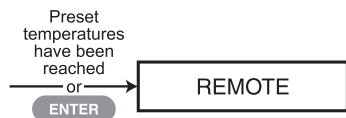

Contents

Chapter 1

Chapter 2

Chapter 3

Chapter 4

Chapter 5

Chapter 6

Function Flowchart [REMOTE mode]

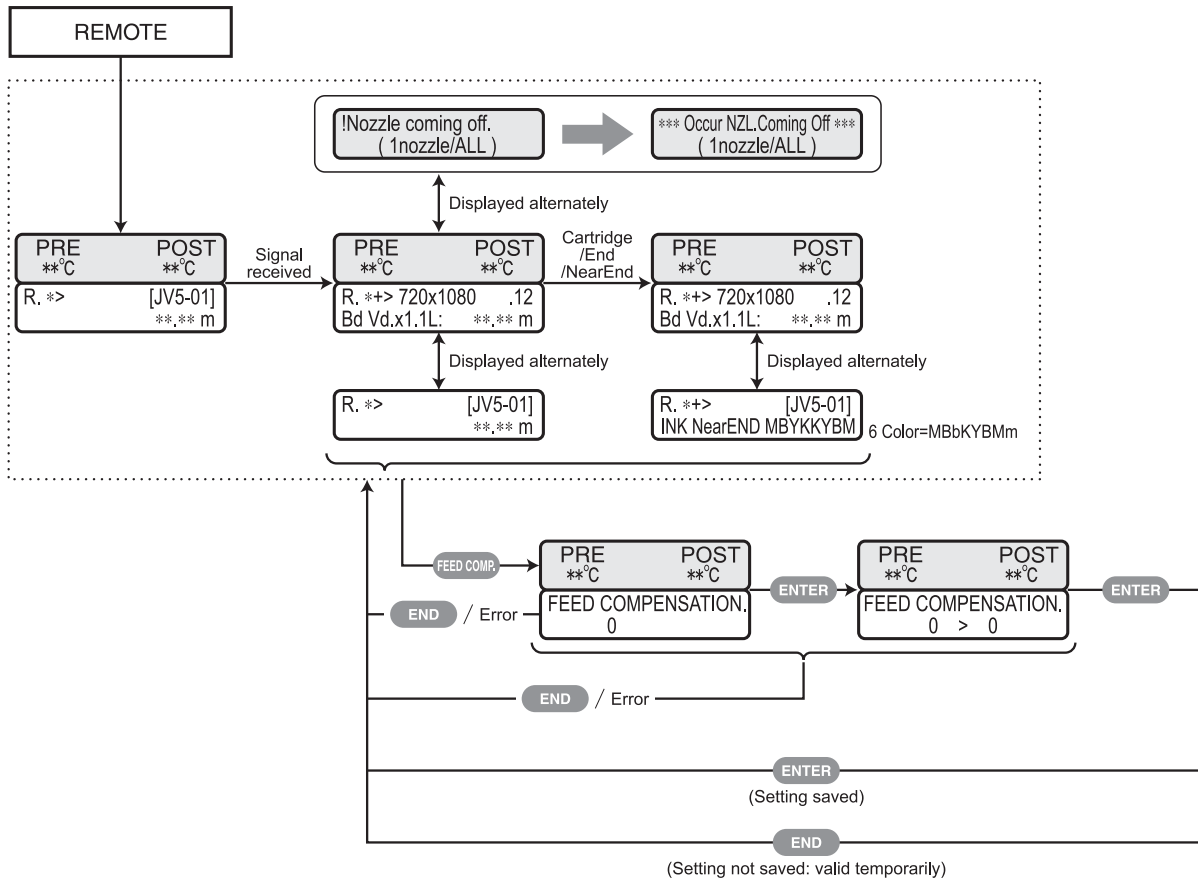

Pressing HEATER key or ENTER key in operations below is to be performed when the printer is in any state shown within the chart enclosed with dotted line above.

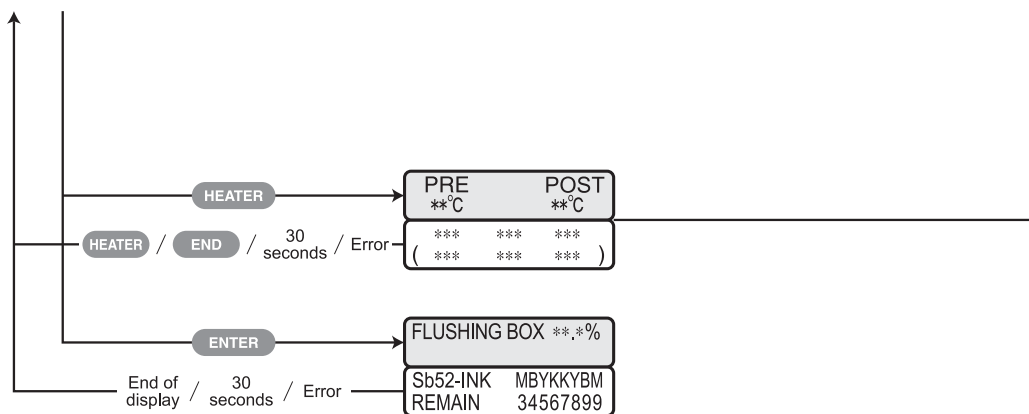

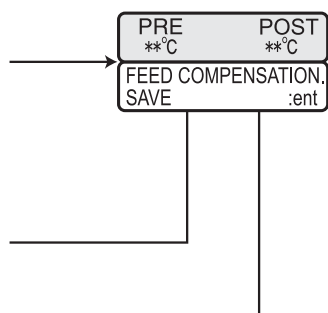

→ { Select the PRE, PRINT and POST one by one with [◀] or [▶] key.
 Adjust each temperature with [▲] or [▼] key.
 Range :OFF, 20 to 60 (PRE/PRINT)
 OFF, 20 to 70 (POST)

Contents

Chapter 1

Chapter 2

Chapter 3

Chapter 4

Chapter 5

Chapter 6

Function Flowchart [FUNCTION Key]

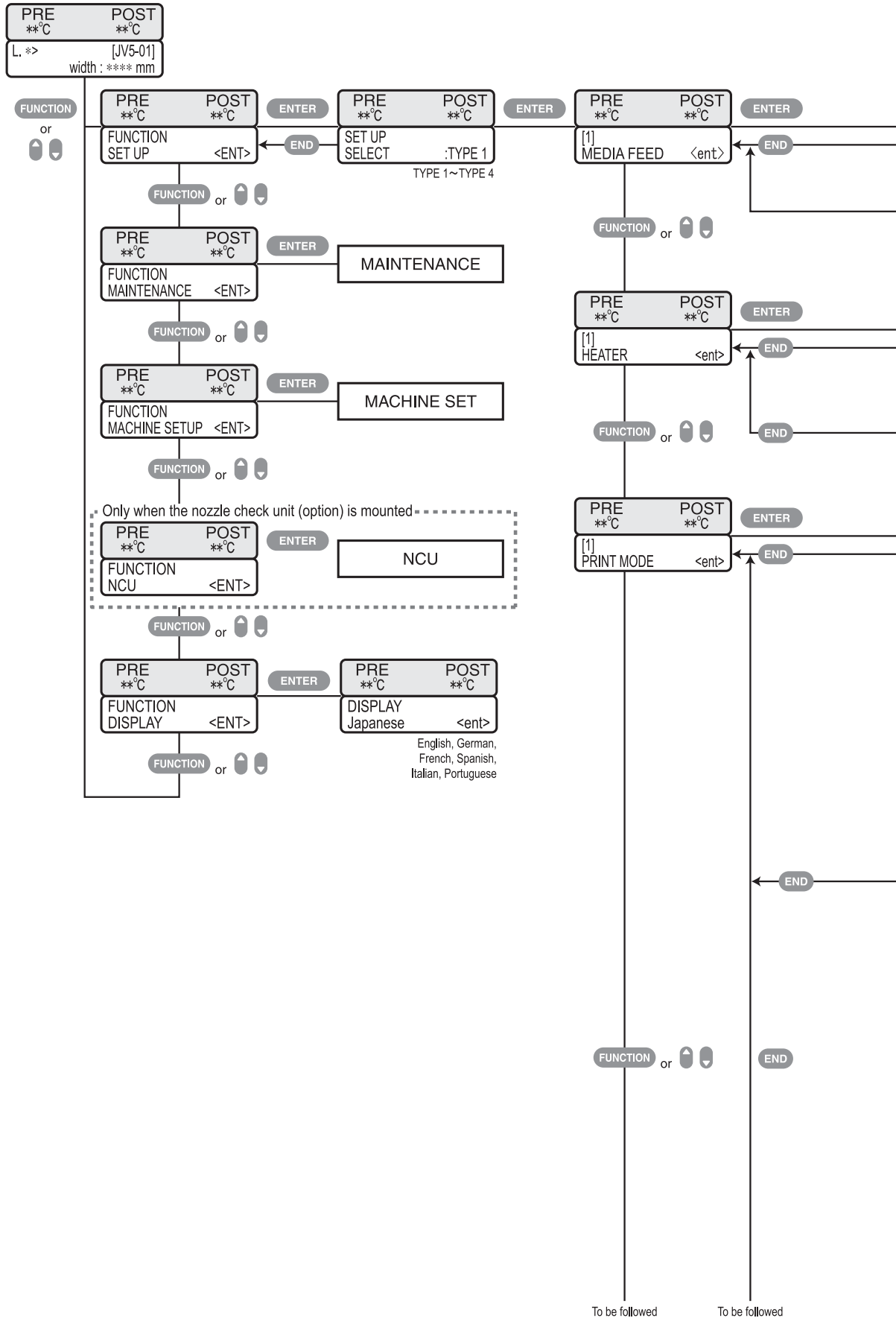

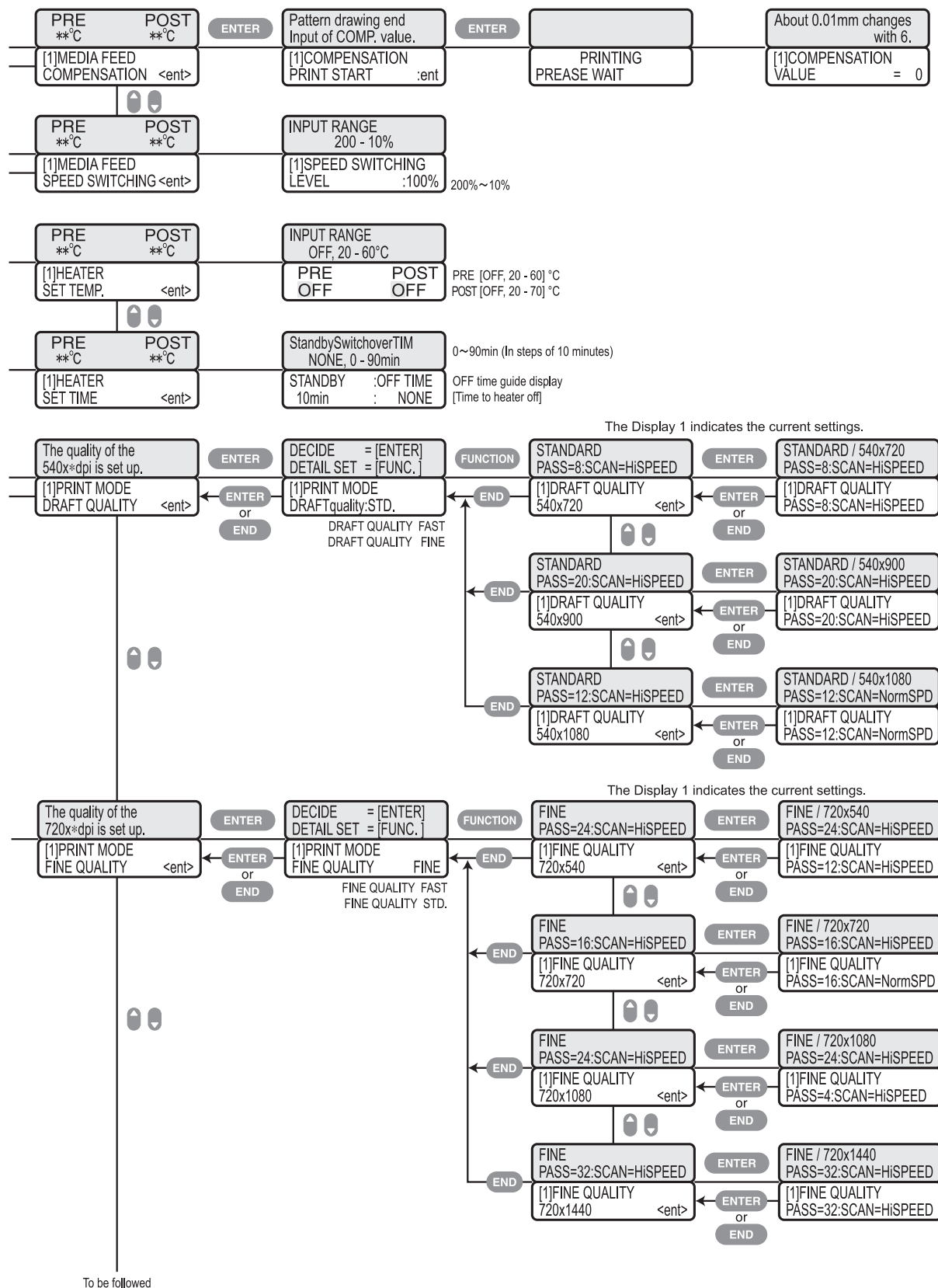

To be followed

Contents

Chapter 1

Chapter 2

Chapter 3

Chapter 4

Chapter 5

Chapter 6

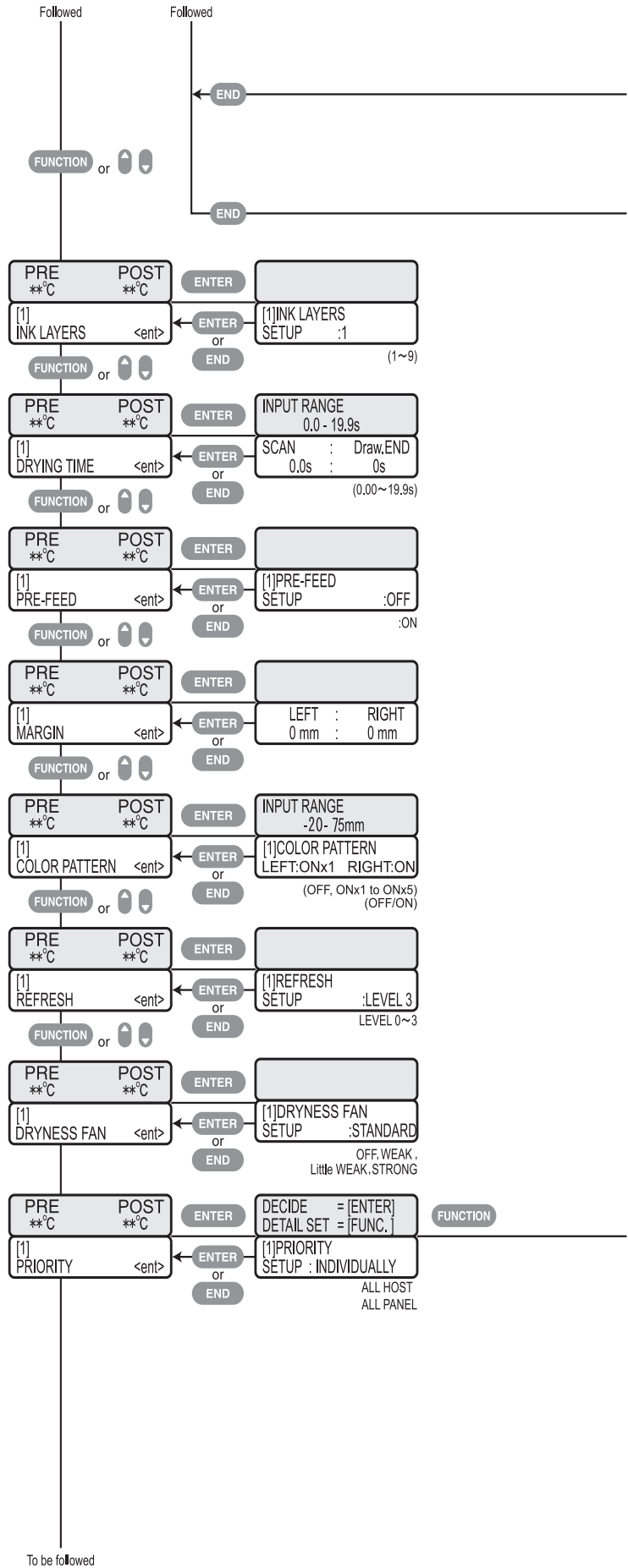

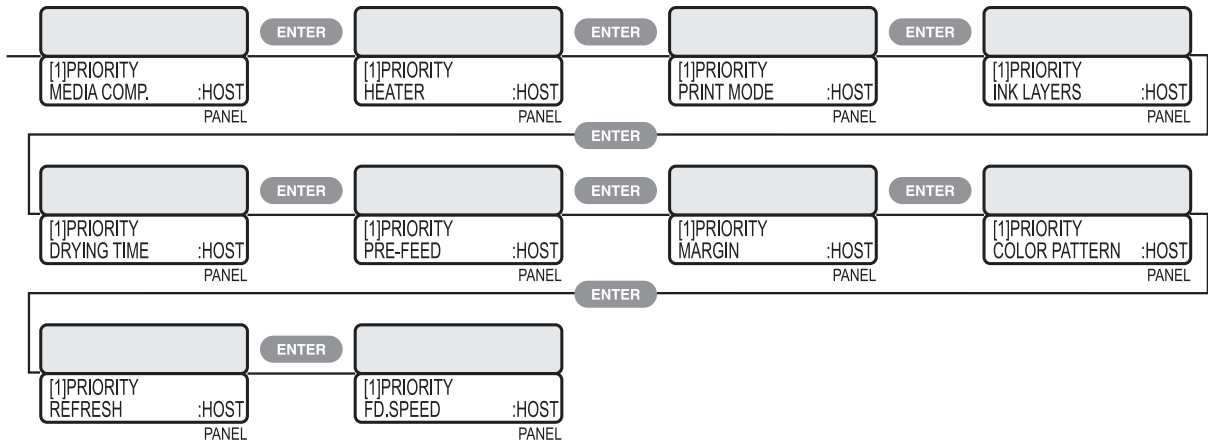
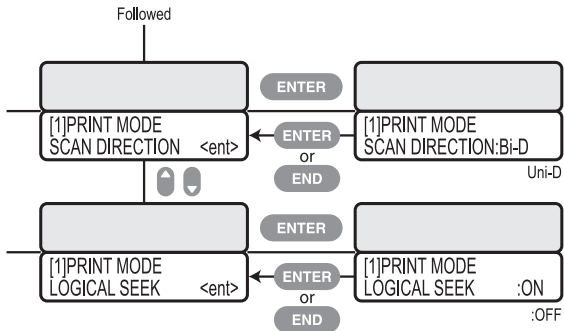

Contents

Chapter 1

Chapter 2

Chapter 3

Chapter 4

Chapter 5

Chapter 6

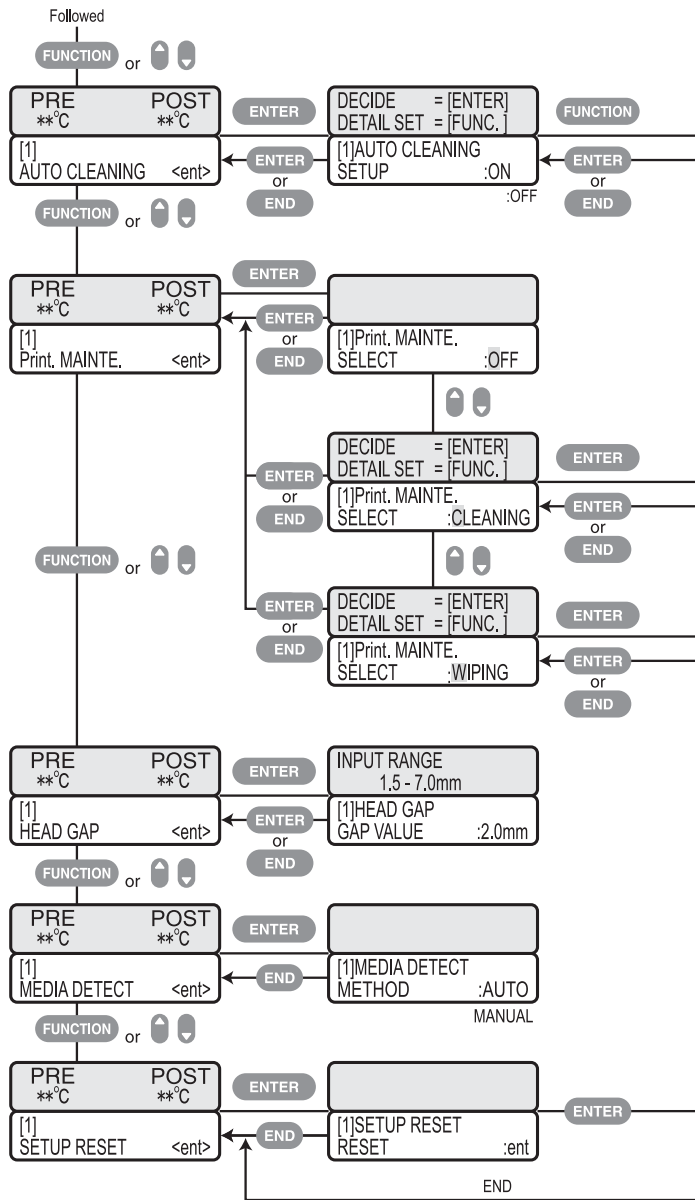

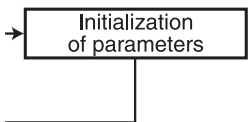
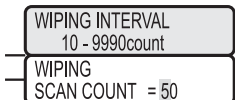
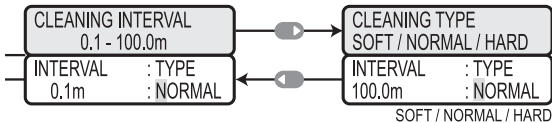
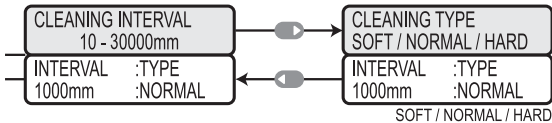

Contents

Chapter 1

Chapter 2

Chapter 3

Chapter 4

Chapter 5

Chapter 6

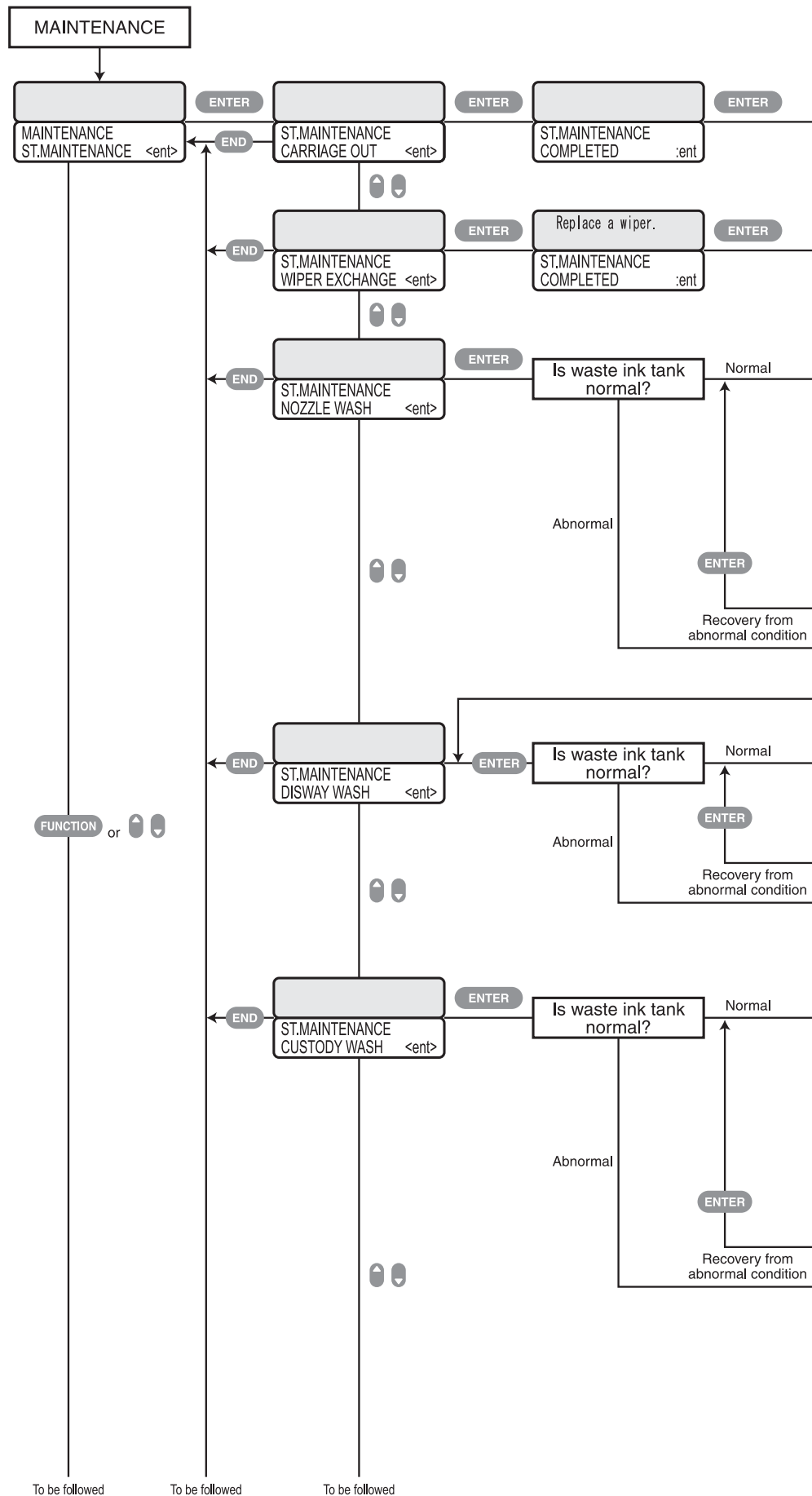

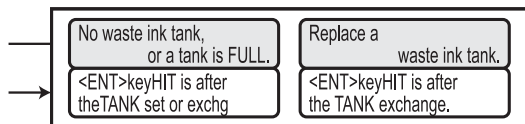
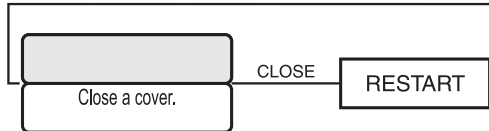
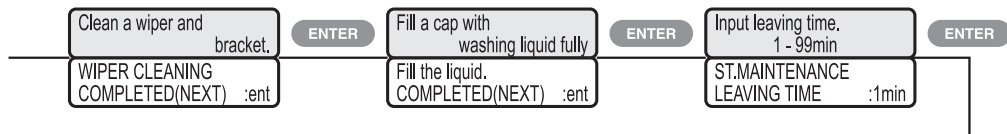
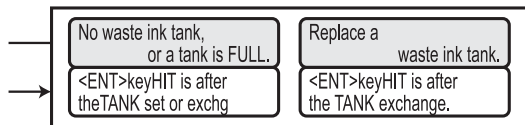
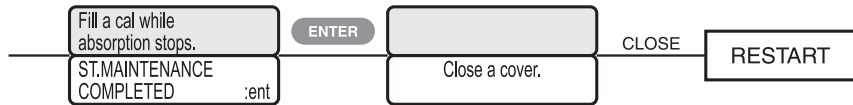
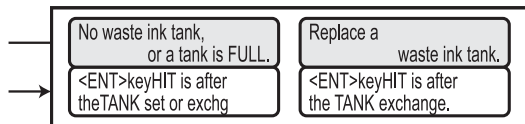
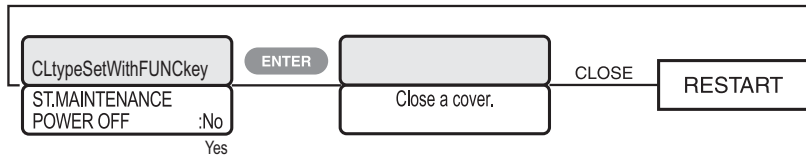
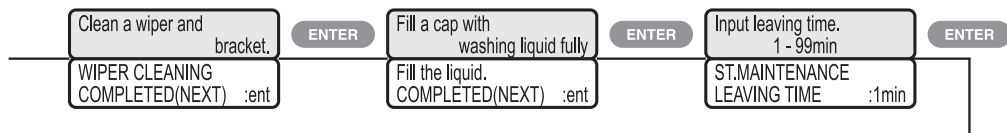
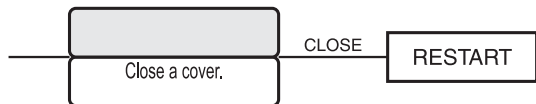
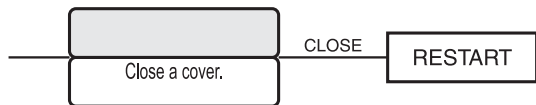

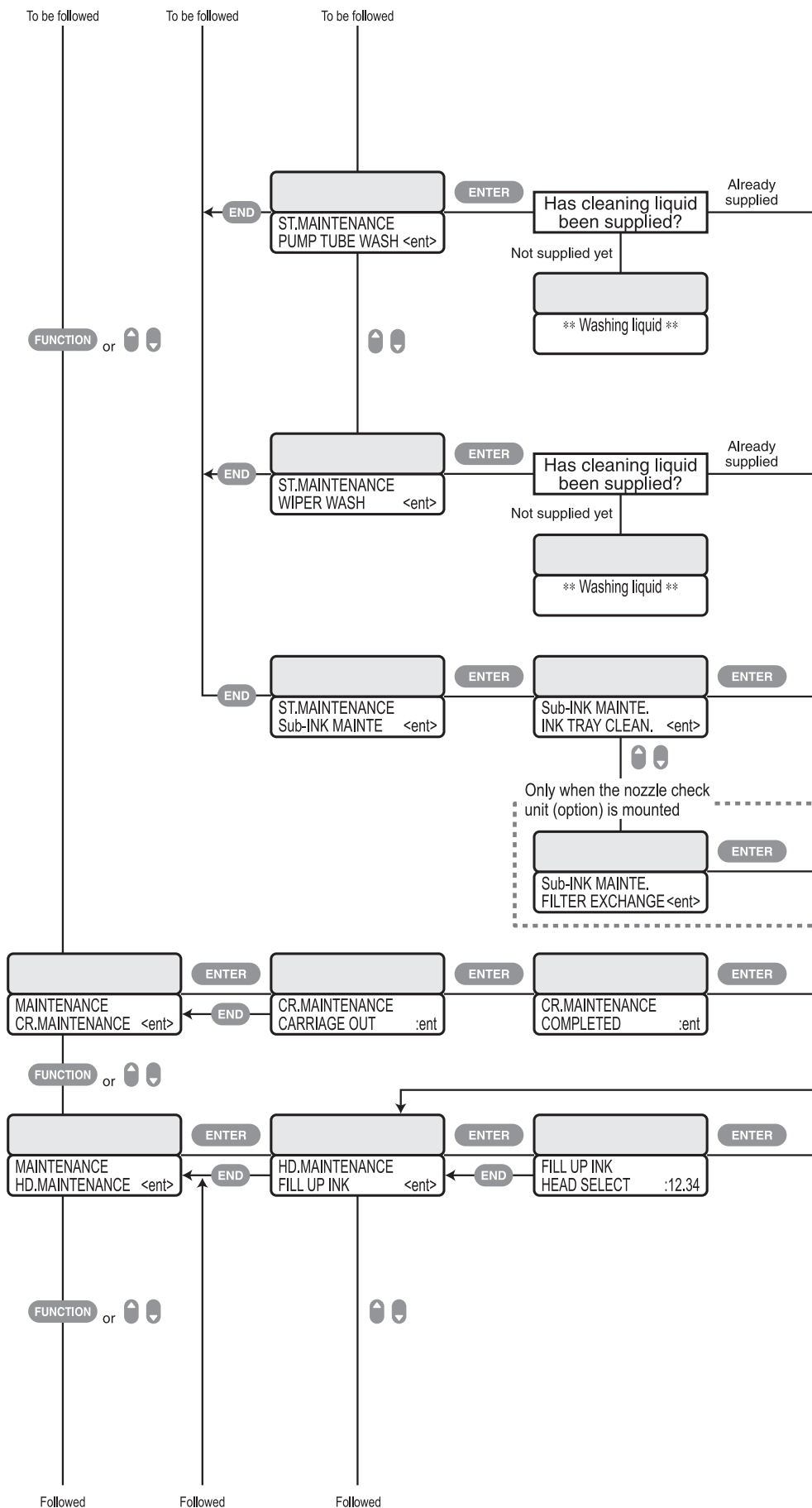

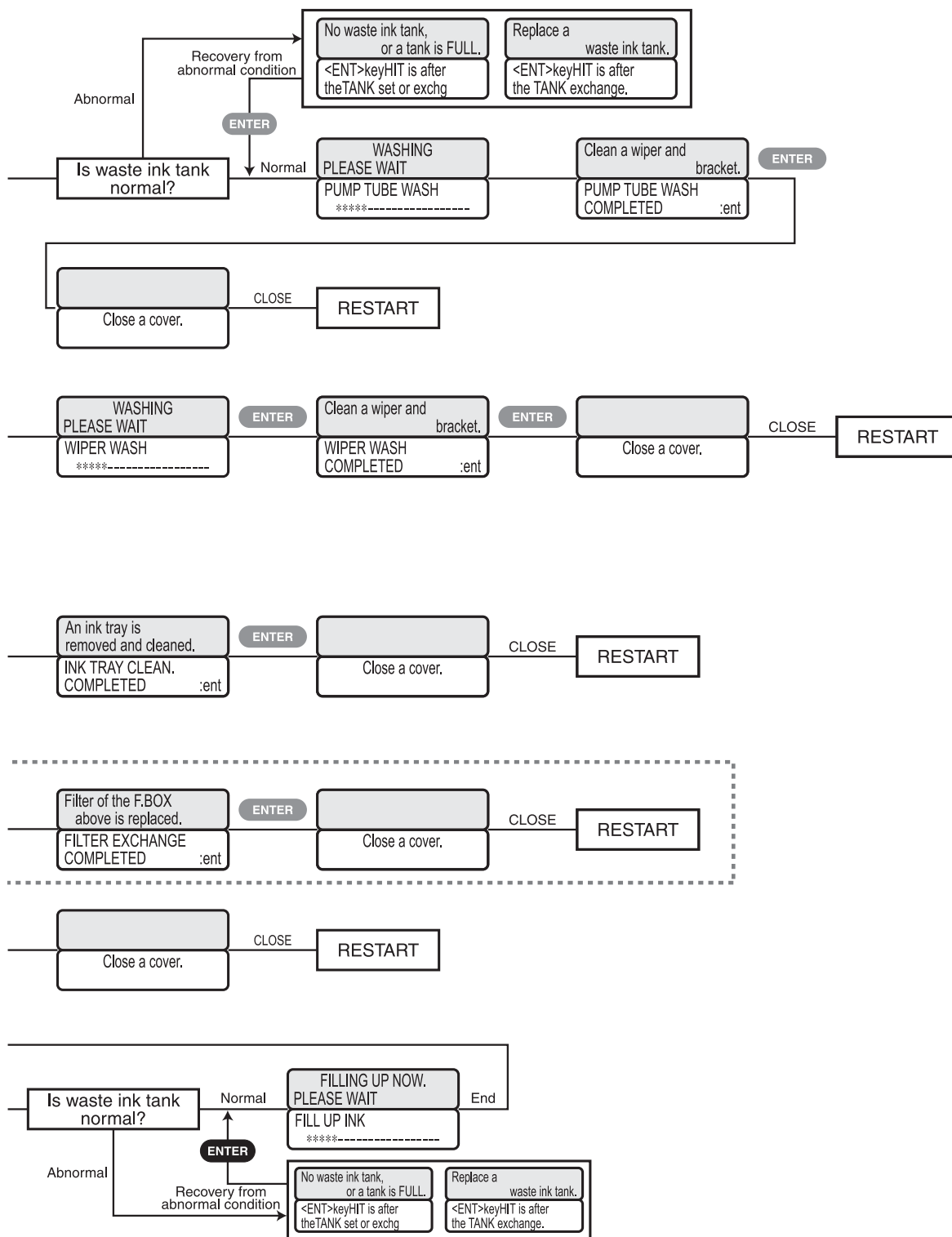

Contents

Chapter 1

Chapter 2

Chapter 3

Chapter 4

Chapter 5

Chapter 6

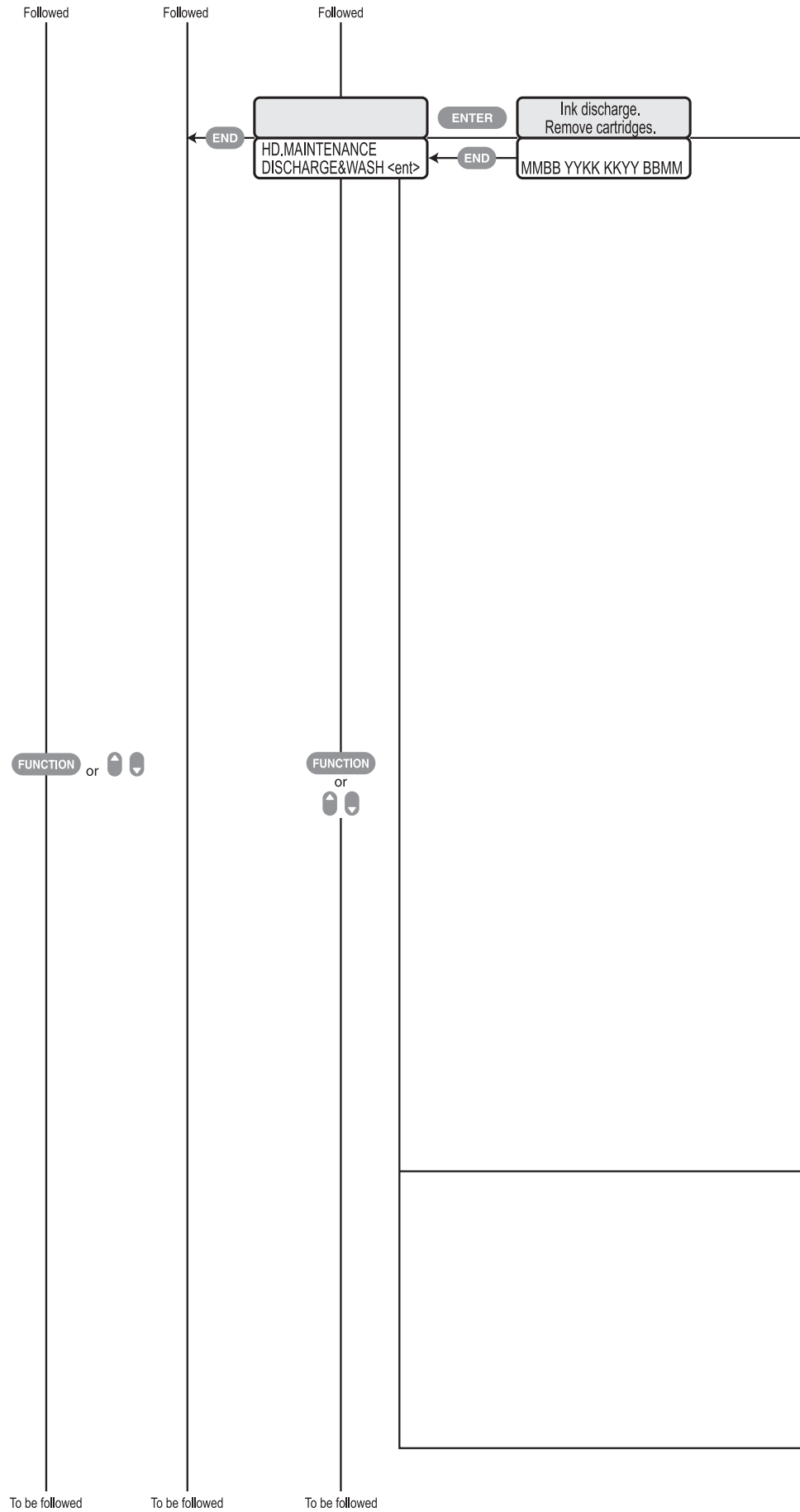

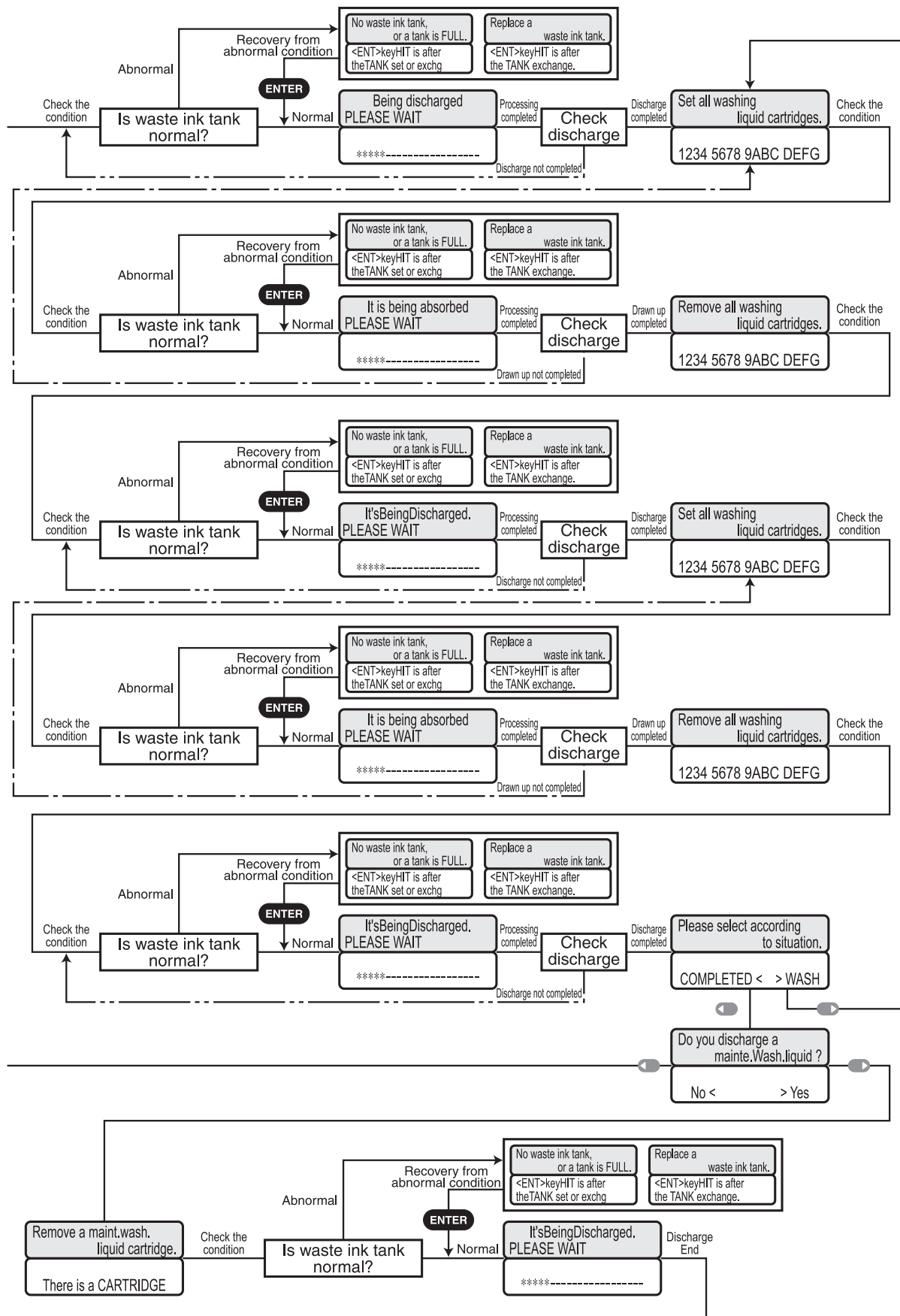

Contents

Chapter 1

Chapter 2

Chapter 3

Chapter 4

Chapter 5

Chapter 6

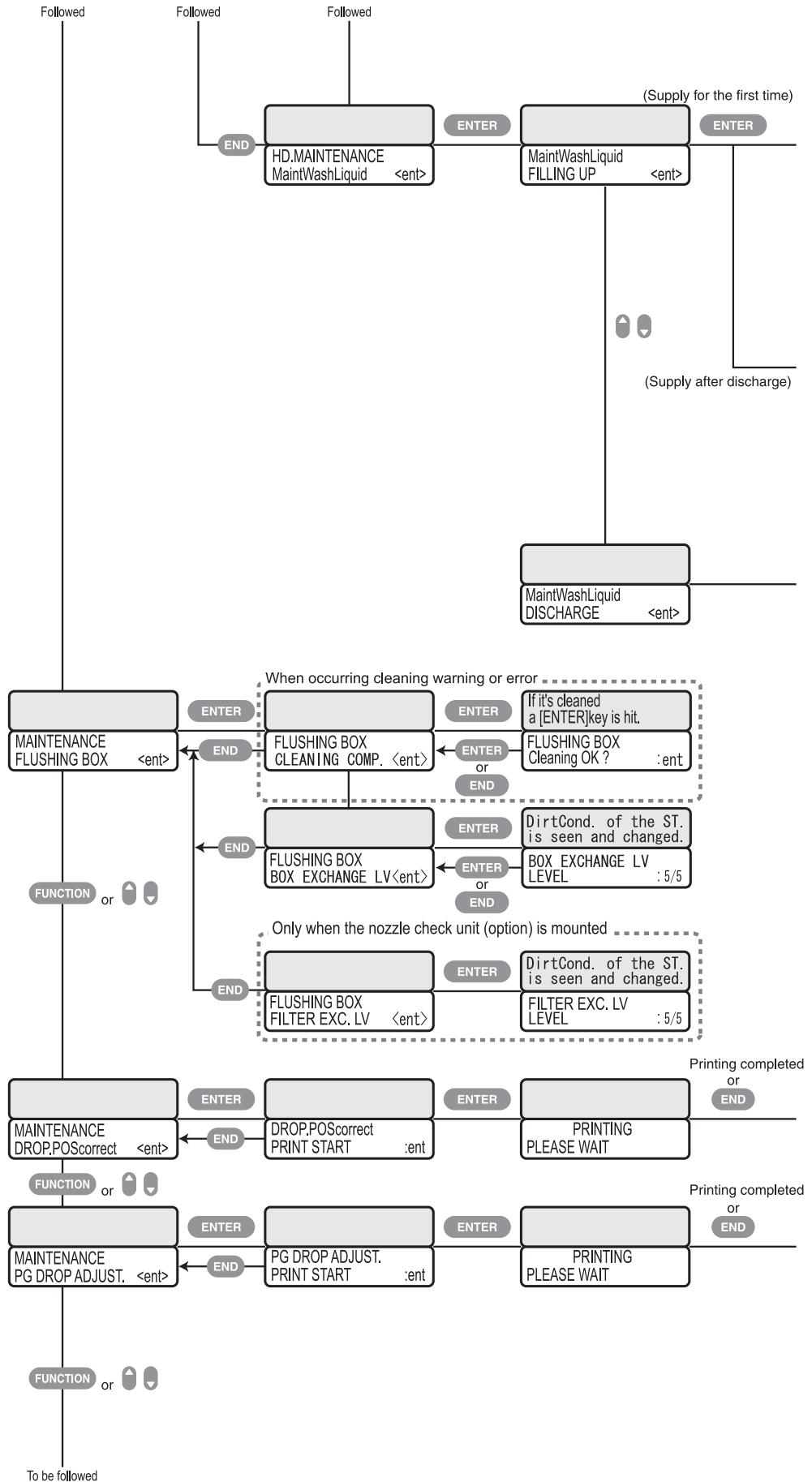

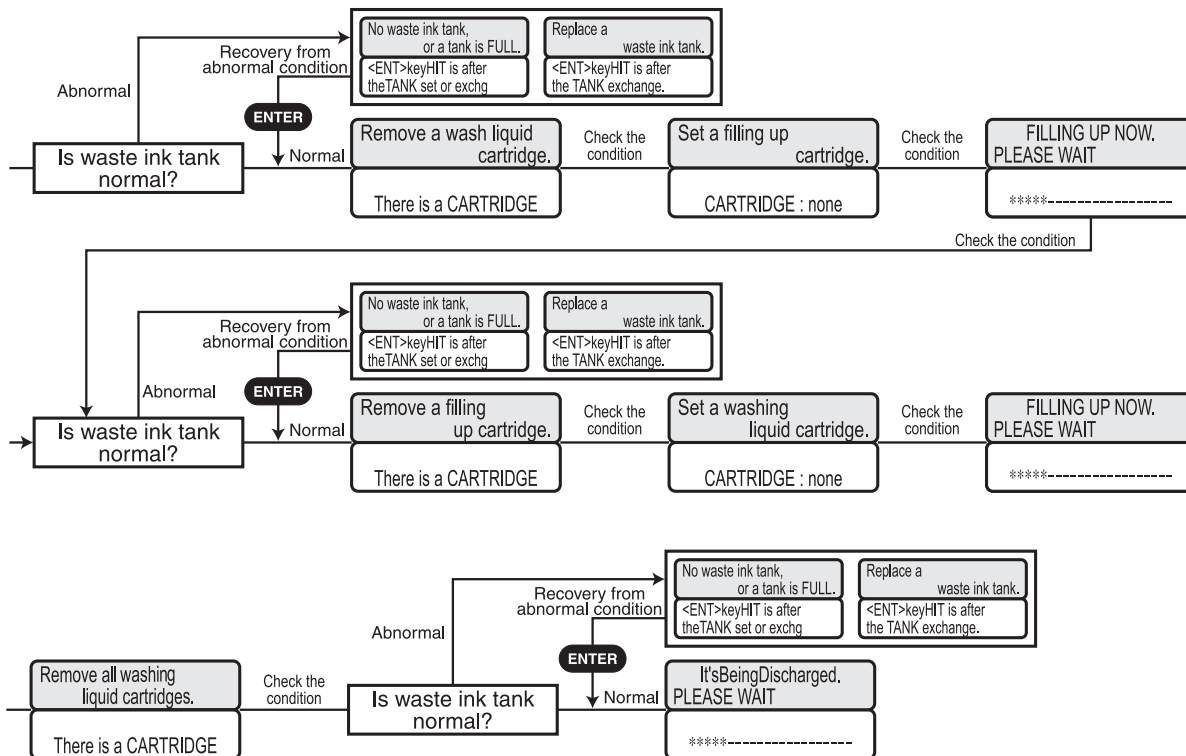

Input COMP value.
-40.0 - +40.0
DROP,POScorrect
PATTERN1 = 0.0
Pattern 1~44
-40.0~40.0

Input COMP value.
-40.0 - +40.0
PG DROP ADJUST.
PATTERN1 = 0.0
Pattern 1~4
-40.0~40.0

Contents

Chapter 1

Chapter 2

Chapter 3

Chapter 4

Chapter 5

Chapter 6

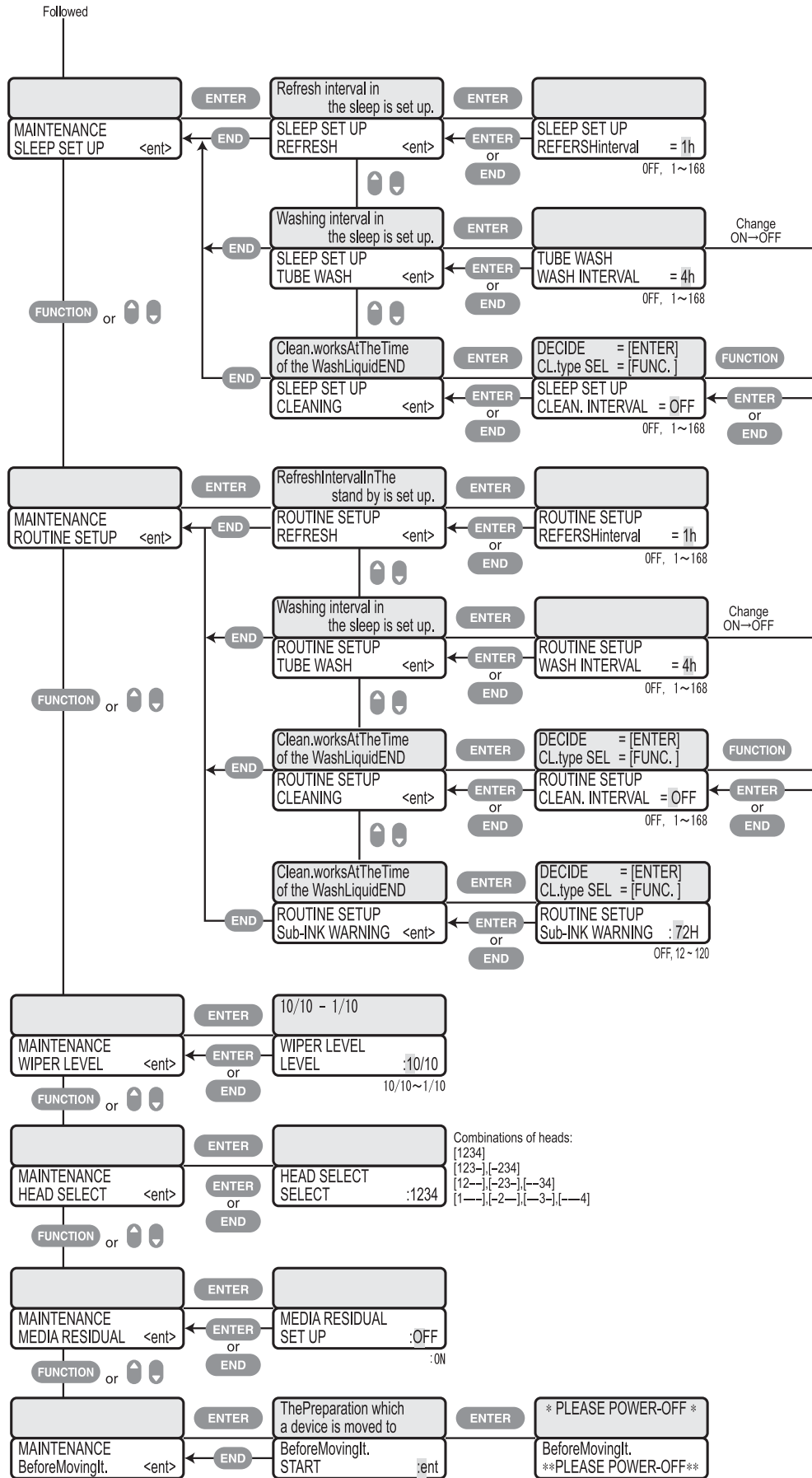

When filling with cleaning liquid is needed

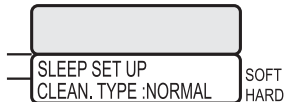
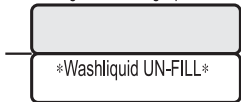

When filling with cleaning liquid is needed

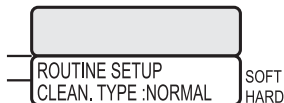

Contents

Chapter 1

Chapter 2

Chapter 3

Chapter 4

Chapter 5

Chapter 6

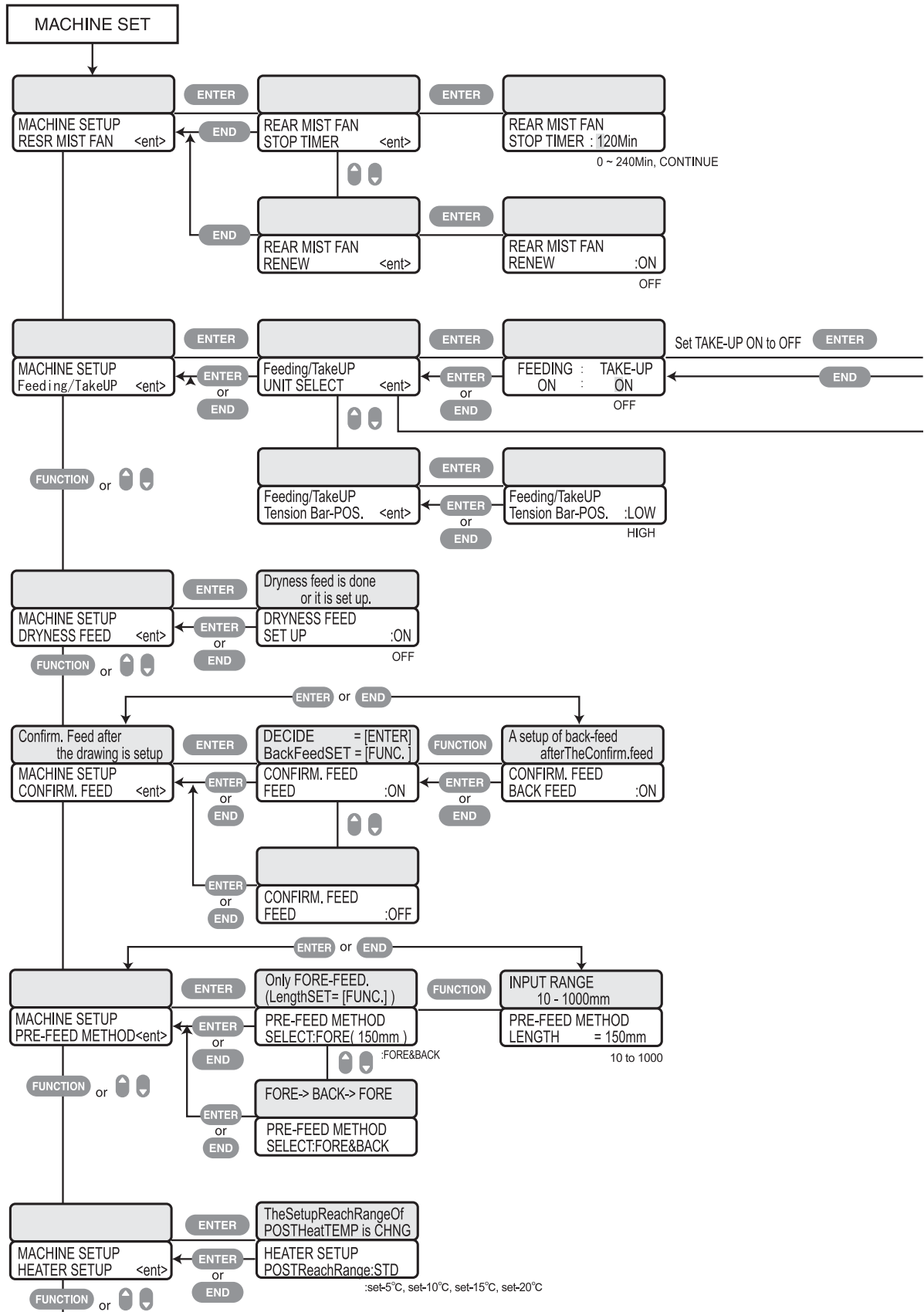

To be followed

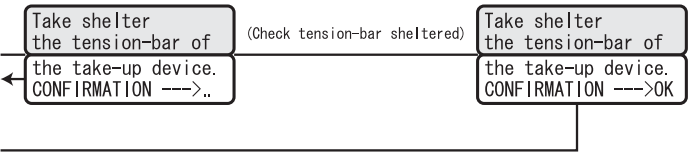

Contents

Chapter 1

Chapter 2

Chapter 3

Chapter 4

Chapter 5

Chapter 6

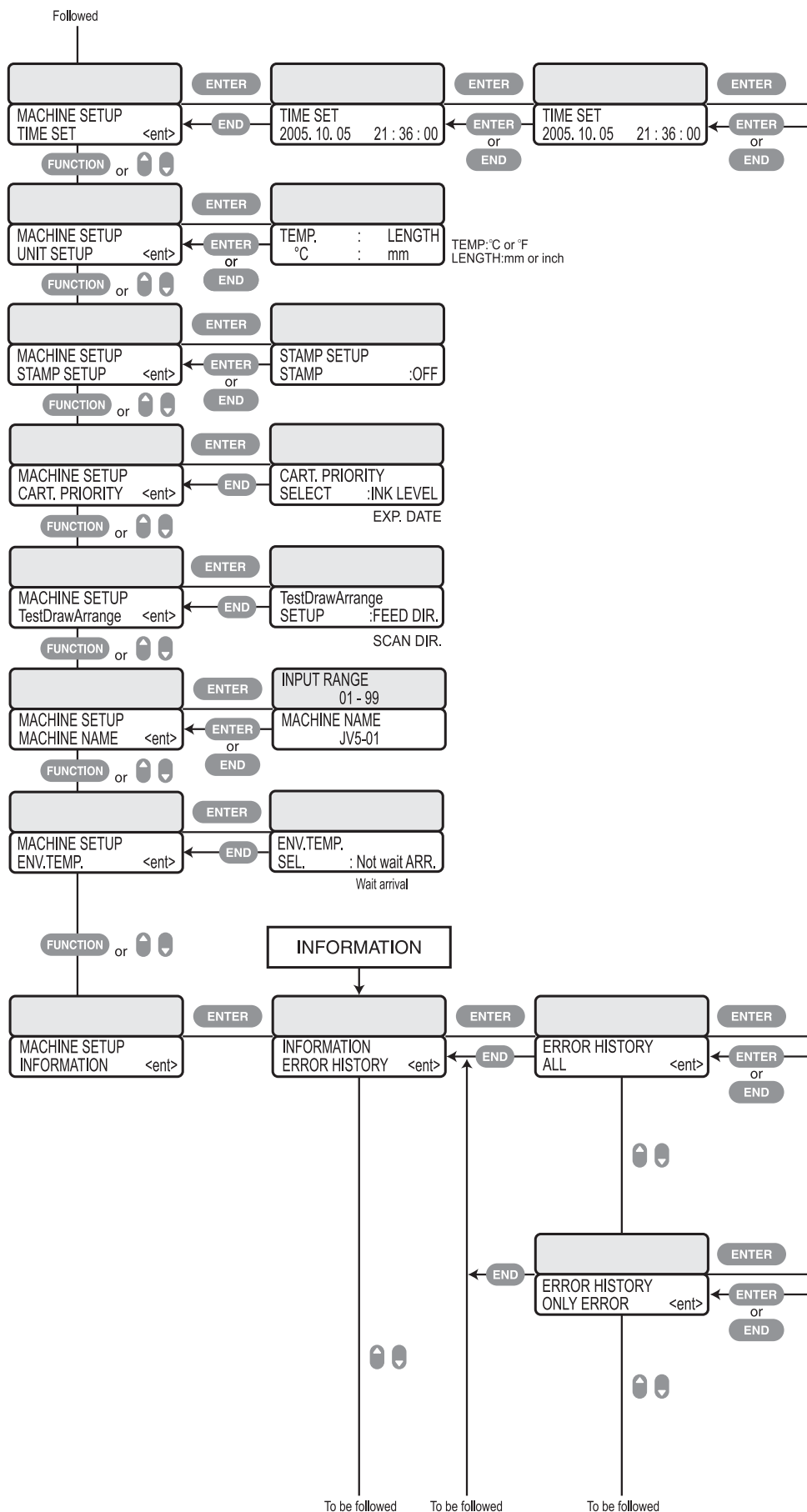

```

2006.11.23 09:15
-> 2005.12.13 11:50
TIME SET
DoYou change it? .ent

```

```

ERROR HISTORY
0001> 08. 11. 11 05:54
**** ERROR 65 ****
TAKE-UP TENSION-BAR

```



```

ERROR HISTORY
0002> 08. 11. 11 05:50
! WashLiquidCart.NONE

```

```

ERROR HISTORY
0001> 08. 11. 11 05:54
**** ERROR 65 ****
TAKE-UP TENSION-BAR

```



```

ERROR HISTORY
0002> 08. 11. 11 05:11
**** ERROR 120 ****
ENVIRONMENT TEMP (1.0)

```

Contents

Chapter 1

Chapter 2

Chapter 3

Chapter 4

Chapter 5

Chapter 6

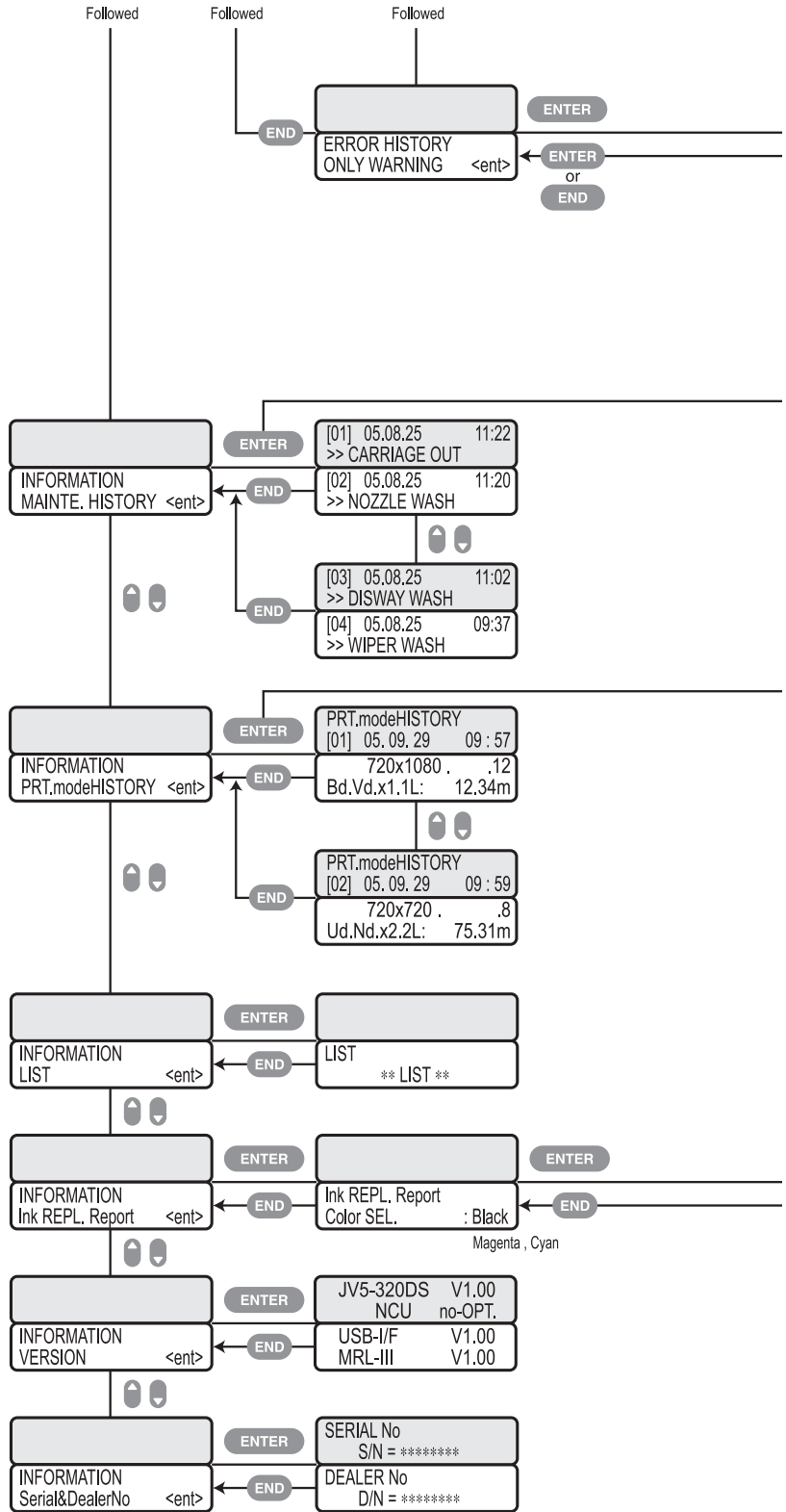

ERROR HISTORY
0001> 08. 11. 11 05:50
! WashLiquidCart.NONE



ERROR HISTORY
0002> 08. 11. 11 00:49
! Feeding CoverOPEN

↓
** There is no **
** HISTORY **

↓
** There is no **
** HISTORY **

Ink REPL. Report
PRINT START :ent

Contents

Chapter 1

Chapter 2

Chapter 3

Chapter 4

Chapter 5

Chapter 6

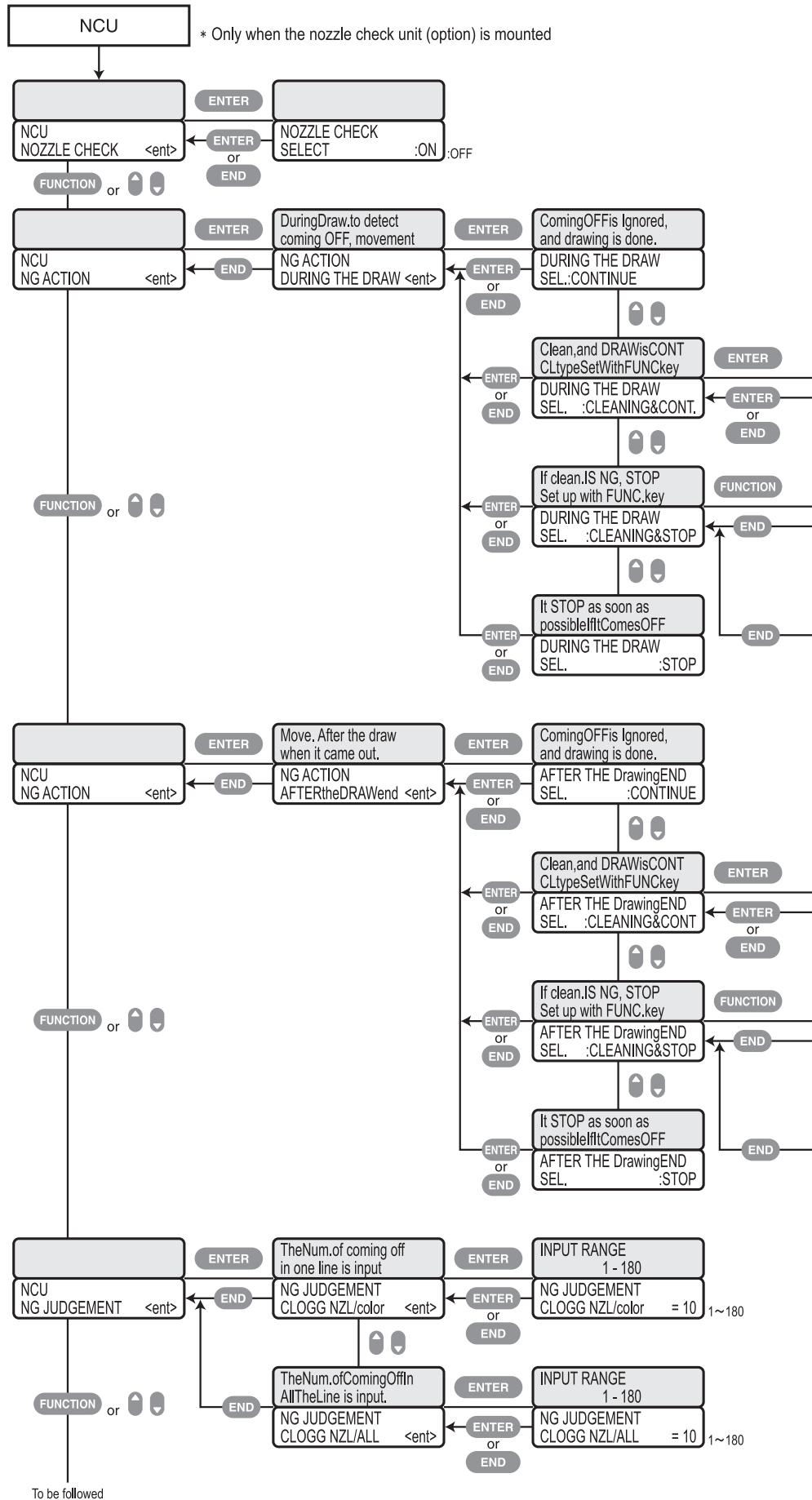

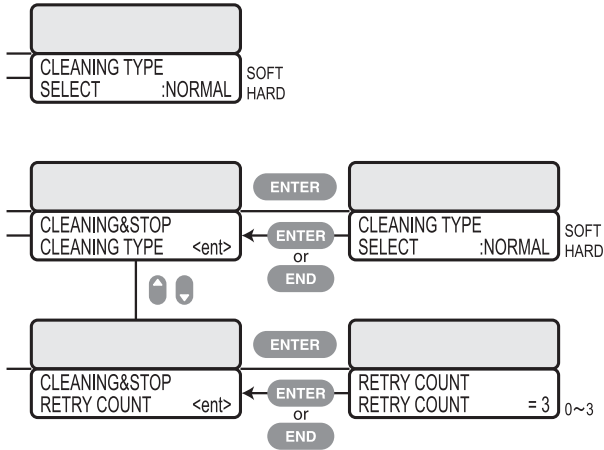
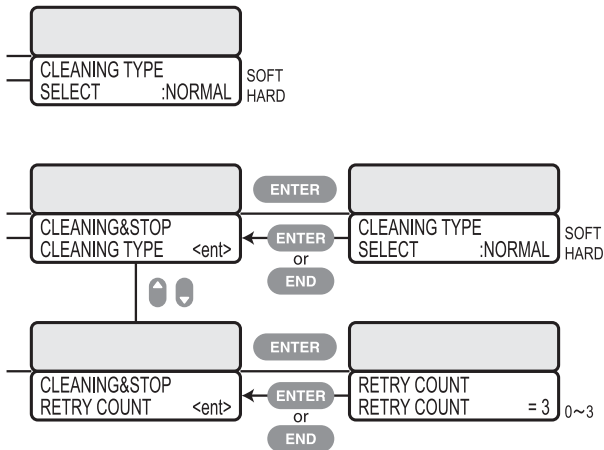

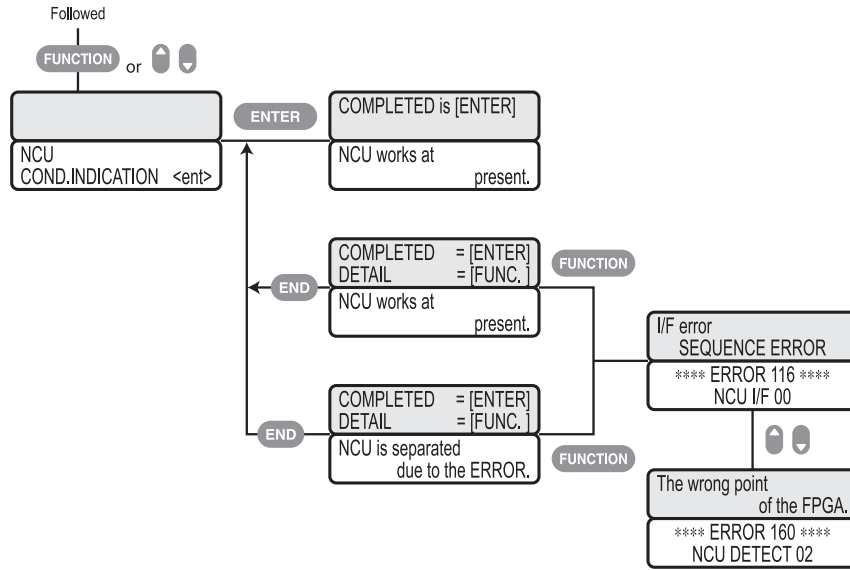

Contents

Chapter 1

Chapter 2

Chapter 3

Chapter 4

Chapter 5

Chapter 6

D202100-13-31102014

MimakiTM